

AOS-W Instant

6.4.4.4-4.2.3.0

Alcatel·Lucent 
Enterprise

User Guide

Copyright

© 2016 Alcatel-Lucent. All rights reserved.

Specifications in this manual are subject to change without notice.

Originated in the USA.

AOS-W, Alcatel 4302, Alcatel 4304, Alcatel 4306, Alcatel 4308, Alcatel 4324, Alcatel 4504, Alcatel 4604, Alcatel 4704, Alcatel 6000, OAW-AP41, OAW-AP68, OAW-AP60/61/65, OAW-AP70, OAW-AP80, OAW-AP92/93, OAW-AP105, OAW-AP120/121, OAW-AP124/125, OAW-AP175, OAW-IAP92/93/105, OAW-RAP2, OAW-RAP5, and OmniVista 3600 Air Manager are trademarks of Alcatel-Lucent in the United States and certain other countries.

Any other trademarks appearing in this manual are the property of their respective companies. Includes software from Litech Systems Design. The IF-MAP client library copyright 2011 Infoblox, Inc. All rights reserved. This product includes software developed by Lars Fenneberg et al.

Legal Notice

The use of Alcatel-Lucent switching platforms and software, by all individuals or corporations, to terminate Cisco or Nortel VPN client devices constitutes complete acceptance of liability by that individual or corporation for this action and indemnifies, in full, Alcatel-Lucent from any and all legal actions that might be taken against it with respect to infringement of copyright on behalf of Cisco Systems or Nortel Networks.

About this Guide	27
Intended Audience	27
Related Documents	27
Conventions	27
Contacting Support	28
About AOS-W Instant	29
AOS-W Instant Overview	29
Supported AP Platforms	29
AOS-W Instant UI	32
AOS-W Instant CLI	32
What is New in this Release	32
Setting up an OAW-IAP	34
Setting up AOS-W Instant Network	34
Connecting an OAW-IAP	34
Assigning an IP address to the OAW-IAP	34
Assigning a Static IP	35
Connecting to a Provisioning Wi-Fi Network	35
OAW-IAP Cluster	35
Disabling the Provisioning Wi-Fi Network	36
Provisioning OAW-IAPs through OmniVista	36
Logging in to the AOS-W Instant UI	36
Regulatory Domains	37
Specifying Country Code	37
Accessing the AOS-W Instant CLI	38
Connecting to a CLI Session	38
Applying Configuration Changes	39
Using Sequence Sensitive Commands	39
Automatic Retrieval of Configuration	41
Managed Mode Operations	41
Pre-requisites	41

Configuring Managed Mode Parameters	42
Example	43
Verifying the Configuration	43
AOS-W Instant User Interface	44
Login Screen	44
Viewing Connectivity Summary	44
Language	44
Logging into the AOS-W Instant UI	44
Main Window	45
Banner	45
Search	45
Tabs	45
Networks Tab	46
Access Points Tab	46
Clients Tab	47
Links	47
New Version Available	47
System	48
RF	48
Security	48
Maintenance	49
More	49
VPN	50
IDS	50
Wired	51
Services	52
DHCP Server	53
Support	53
Help	53
Logout	54
Monitoring	54
Info	54
RF Dashboard	56
RF Trends	58
Usage Trends	58

Mobility Trail	64
Client Match	64
AppRF	65
Spectrum	65
Alerts	66
IDS	70
AirGroup	71
Configuration	71
OmniVista 3600 Setup	72
Pause/Resume	72
Views	72
Initial Configuration Tasks	74
Configuring System Parameters	74
Changing Password	80
In the AOS-W Instant UI	80
In the CLI	80
Customizing OAW-IAP Settings	81
Modifying the OAW-IAP Hostname	81
In the AOS-W Instant UI	81
In the CLI	81
Configuring Zone Settings on an OAW-IAP	81
In the AOS-W Instant UI	81
In the CLI	82
Specifying a Method for Obtaining IP Address	82
In the AOS-W Instant UI	82
In the CLI	82
Configuring External Antenna	82
EIRP and Antenna Gain	82
Configuring Antenna Gain	83
In the AOS-W Instant UI	83
In the CLI	83
Configuring Radio Profiles for an OAW-IAP	83
Configuring ARM Assigned Radio Profiles for an OAW-IAP	84
Configuring Radio Profiles Manually for OAW-IAP	84

In the CLI	85
Configuring Uplink VLAN for an OAW-IAP	85
In the AOS-W Instant UI	85
In the CLI	85
Changing USB Port Status	86
In the AOS-W Instant UI	86
In the CLI	86
Master Election and Virtual Controller	86
Master Election Protocol	86
Preference to an OAW-IAP with 3G/4G Card	87
Preference to an OAW-IAP with Non-Default IP	87
Viewing Master Election Details	87
Manual Provisioning of Master OAW-IAP	87
Provisioning an OAW-IAP as a Master OAW-IAP	87
In the AOS-W Instant UI	87
In the CLI	88
Adding an OAW-IAP to the Network	88
Removing an OAW-IAP from the Network	88
VLAN Configuration	89
VLAN Pooling	89
Uplink VLAN Monitoring and Detection on Upstream Devices	89
Wireless Network Profiles	90
Configuring Wireless Network Profiles	90
Network Types	90
Configuring WLAN Settings for an SSID Profile	91
In the AOS-W Instant UI	91
In the CLI	95
Configuring VLAN Settings for a WLAN SSID Profile	95
In the AOS-W Instant UI	96
In the CLI	97
Enforcing DHCP	98
Configuring Security Settings for a WLAN SSID Profile	98
Configuring Security Settings for an Employee or Voice Network	98
In the AOS-W Instant UI	98

In the CLI	104
Configuring Access Rules for a WLAN SSID Profile	105
In the AOS-W Instant UI	106
In the CLI	106
Configuring Per-AP SSID and Per-AP-VLAN Settings On a Wireless Profile	107
In the CLI	107
Configuring Fast Roaming for Wireless Clients	108
Opportunistic Key Caching	108
Configuring an OAW-IAP for OKC Roaming	108
In the AOS-W Instant UI	108
In the CLI	109
Fast BSS Transition (802.11r Roaming)	109
Configuring an OAW-IAP for 802.11r support	109
In the AOS-W Instant UI	110
In the CLI	110
Example	110
Radio Resource Management (802.11k)	110
Beacon Report Requests and Probe Responses	110
Configuring a WLAN SSID for 802.11k Support	111
In the AOS-W Instant UI	111
In the CLI	111
Example	111
BSS Transition Management (802.11v)	111
Configuring a WLAN SSID for 802.11v Support	111
In the AOS-W Instant UI	111
In the CLI	112
Example	112
Configuring Modulation Rates on a WLAN SSID	112
Multi-User-MIMO	112
RTS/CTS Flow Control	113
Enabling or Disabling MU-MIMO	113
Configuring RTS/CTS Threshold	113
Disabling Short Preamble for Wireless Client	113
Editing Status of a WLAN SSID Profile	113
In the AOS-W Instant UI	113

In the CLI	114
Editing a WLAN SSID Profile	114
Deleting a WLAN SSID Profile	114
Wired Profiles	115
Configuring a Wired Profile	115
Configuring Wired Settings	115
In the AOS-W Instant UI	115
In the CLI	116
Configuring VLAN for a Wired Profile	116
In the AOS-W Instant UI	116
In the CLI	117
Configuring Security Settings for a Wired Profile	117
Configuring Security Settings for a Wired Employee Network	117
In the AOS-W Instant UI	117
In the CLI	118
Configuring Access Rules for a Wired Profile	118
In the AOS-W Instant UI	118
In the CLI	119
Assigning a Profile to Ethernet Ports	120
In the AOS-W Instant UI	120
In the CLI	120
Editing a Wired Profile	120
Deleting a Wired Profile	120
Link Aggregation Control Protocol	121
Verifying LACP Configuration on the OAW-IAP	121
Enabling Static LACP Configuration	121
Verifying Static LACP Mode	122
Understanding Hierarchical Deployment	122
Captive Portal for Guest Access	124
Understanding Captive Portal	124
Types of Captive Portal	124
Walled Garden	125
Configuring a WLAN SSID for Guest Access	125
In the AOS-W Instant UI	125

In the CLI	130
Configuring Wired Profile for Guest Access	131
In the AOS-W Instant UI	131
In the CLI	132
Configuring Internal Captive Portal for Guest Network	133
In the AOS-W Instant UI	133
In the CLI	135
Configuring External Captive Portal for a Guest Network	136
External Captive Portal Profiles	136
Creating a Captive Portal Profile	136
In the AOS-W Instant UI	136
In the CLI	138
Configuring an SSID or Wired Profile to Use External Captive Portal Authentication	138
In the AOS-W Instant UI	138
In the CLI	140
External Captive Portal Redirect Parameters	140
Configuring External Captive Portal Authentication Using ClearPass Guest	141
Creating a Web Login page in ClearPass Guest	141
Configuring RADIUS Server in AOS-W Instant UI	141
Configuring RADIUS Attribute for ClearPass Policy Manager Server Load Balancing	142
Configuring Facebook Login	142
Setting up a Facebook Page	142
Configuring an SSID	142
In the AOS-W Instant UI	142
In the CLI	143
Example	143
Configuring the Facebook Portal Page	143
Accessing the Portal Page	143
Configuring Guest Logon Role and Access Rules for Guest Users	143
In the AOS-W Instant UI	144
In the CLI	144
Example	145
Configuring Captive Portal Roles for an SSID	145
In the AOS-W Instant UI	146

In the CLI	148
Configuring Walled Garden Access	148
In the AOS-W Instant UI	148
In the CLI	149
Disabling Captive Portal Authentication	149
Authentication and User Management	150
Managing OAW-IAP Users	150
Configuring OAW-IAP Users	151
In the AOS-W Instant UI	151
In the CLI	152
Configuring Authentication Parameters for Management Users	153
In the AOS-W Instant UI	153
In the CLI	154
Adding Guest Users through the Guest Management Interface	154
Supported Authentication Methods	155
802.1X Authentication	156
MAC Authentication	156
MAC Authentication with 802.1X Authentication	156
Captive Portal Authentication	156
MAC authentication with Captive Portal authentication	157
802.1X authentication with Captive Portal Role	157
WISPr authentication	157
Supported EAP Authentication Frameworks	157
Authentication Termination on OAW-IAP	158
Configuring Authentication Servers	158
Supported Authentication Servers	158
Internal RADIUS Server	158
External RADIUS Server	159
RADIUS Server Authentication with VSA	159
TACACS Servers	163
Dynamic Load Balancing between Two Authentication Servers	163
Configuring an External Server for Authentication	163
In the AOS-W Instant UI	164
In the CLI	167

Enabling RADIUS Communication over TLS	168
Configuring RadSec Protocol	168
In the UI	168
In the CLI	169
Associate the Server Profile with a Network Profile	169
In the CLI	169
Configuring Dynamic RADIUS Proxy Parameters	170
Enabling Dynamic RADIUS Proxy	170
In the AOS-W Instant UI	170
In the CLI	170
Configuring Dynamic RADIUS Proxy Parameters	170
In the AOS-W Instant UI	170
In the CLI	171
Associate Server Profiles to a Network Profile	171
In the CLI	171
Understanding Encryption Types	172
WPA and WPA2	172
Recommended Authentication and Encryption Combinations	173
Configuring Authentication Survivability	173
Enabling Authentication Survivability	173
In the AOS-W Instant UI	174
Important Points to Remember	174
In the CLI	174
Configuring 802.1X Authentication for a Network Profile	174
Configuring 802.1X Authentication for a Wireless Network Profile	175
In the AOS-W Instant UI	175
In the CLI	175
Configuring 802.1X Authentication for Wired Profiles	176
In the AOS-W Instant UI	176
In the CLI	176
Enabling 802.1X Supplicant Support	176
Configuring an OAW-IAP for 802.1X Supplicant Support	177
In the UI	177
In the CLI	177
Configuring MAC Authentication for a Network Profile	178

Configuring MAC Authentication for Wireless Network Profiles	178
In the AOS-W Instant UI	178
In the CLI	179
Configuring MAC Authentication for Wired Profiles	179
In the AOS-W Instant UI	179
In the CLI	179
Configuring MAC Authentication with 802.1X Authentication	180
Configuring MAC and 802.1X Authentication for a Wireless Network Profile	180
In the AOS-W Instant UI	180
In the CLI	180
Configuring MAC and 802.1X Authentication for Wired Profiles	181
In the AOS-W Instant UI	181
In the CLI	181
Configuring MAC Authentication with Captive Portal Authentication	181
In the AOS-W Instant UI	181
In the CLI	182
Configuring WISPr Authentication	182
In the AOS-W Instant UI	182
In the CLI	183
Blacklisting Clients	183
Blacklisting Clients Manually	184
Adding a Client to the Blacklist	184
In the AOS-W Instant UI	184
In the CLI	184
Blacklisting Users Dynamically	184
Authentication Failure Blacklisting	184
Session Firewall Based Blacklisting	185
Configuring Blacklist Duration	185
In the AOS-W Instant UI	185
In the CLI	185
Uploading Certificates	186
Loading Certificates through AOS-W Instant UI	186
Loading Certificates through AOS-W Instant CLI	186
Removing Certificates	187

Loading Certificates through OmniVista	187
Roles and Policies	189
Firewall Policies	189
Access Control List Rules	189
Configuring ACL Rules for Network Services	189
In the AOS-W Instant UI	190
In the CLI	191
Example	191
Configuring Network Address Translation Rules	192
Configuring a Source NAT Access Rule	192
In the AOS-W Instant UI	192
In the CLI	193
Configuring Source-Based Routing	193
Configuring a Destination NAT Access Rule	193
In the AOS-W Instant UI	193
In the CLI	194
Configuring ALG Protocols	194
In the AOS-W Instant UI	194
In the CLI	194
Configuring Firewall Settings for Protection from ARP Attacks	195
In the AOS-W Instant UI	195
In the CLI	195
Managing Inbound Traffic	196
Configuring Inbound Firewall Rules	196
In the AOS-W Instant UI	196
In the CLI	198
Example	198
Configuring Management Subnets	199
In the AOS-W Instant UI	199
In the CLI	199
Configuring Restricted Access to Corporate Network	199
In the AOS-W Instant UI	199
In the CLI	200
Content Filtering	200
Enabling Content Filtering	200

Enabling Content Filtering for a Wireless Profile	200
In the AOS-W Instant UI	200
In the CLI	201
Enabling Content Filtering for a Wired Profile	201
In the AOS-W Instant UI	201
In the CLI	201
Configuring Enterprise Domains	201
In the AOS-W Instant UI	201
In the CLI	201
Configuring URL Filtering Policies	202
In the AOS-W Instant UI	202
In the CLI	202
Example	203
Creating Custom Error Page for Web Access Blocked by AppRF Policies	203
Creating a List of Error Page URLs	203
In the AOS-W Instant UI	203
In the CLI	203
Configuring ACL Rules to Redirect Users to a Specific URL	203
In the UI	203
In the CLI	203
Configuring User Roles	204
Creating a User Role	204
In the AOS-W Instant UI	204
In the CLI	204
Assigning Bandwidth Contracts to User Roles	204
In the AOS-W Instant UI	205
In the CLI:	205
Configuring Machine and User Authentication Roles	205
In the AOS-W Instant UI	206
In the CLI	206
Configuring Derivation Rules	206
Understanding Role Assignment Rule	206
RADIUS VSA Attributes	206
MAC-Address Attribute	206
Roles Based on Client Authentication	207

DHCP Option and DHCP Fingerprinting	207
Creating a Role Derivation Rule	207
In the AOS-W Instant UI	207
In the CLI	208
Example	208
Understanding VLAN Assignment	209
Vendor Specific Attributes	209
VLAN Assignment Based on Derivation Rules	210
User Role	211
VLANs Created for an SSID	211
Configuring VLAN Derivation Rules	211
In the AOS-W Instant UI	211
In the CLI	212
Example	212
Using Advanced Expressions in Role and VLAN Derivation Rules	212
Configuring a User Role for VLAN Derivation	213
Creating a User VLAN Role	214
In the AOS-W Instant UI	214
In the CLI	214
Assigning User VLAN Roles to a Network Profile	214
In the AOS-W Instant UI	214
In the CLI	214
DHCP Configuration	215
Configuring DHCP Scopes	215
Configuring Local DHCP Scopes	215
In the AOS-W Instant UI	215
In the CLI	216
Configuring Distributed DHCP Scopes	217
In the AOS-W Instant UI	218
In the CLI	219
Configuring Centralized DHCP Scopes	220
In the AOS-W Instant UI	220
In the CLI	222
Configuring the Default DHCP Scope for Client IP Assignment	222
In the AOS-W Instant UI	223

In the CLI	223
Configuring Time Based Services	225
Time Range Profiles	225
Configuring a Time Range Profile	225
In the AOS-W Instant UI	225
In the CLI:	226
Applying a Time Range Profile to a WLAN SSID	226
In the CLI	227
Verifying the Configuration	227
Example	227
Dynamic DNS Registration	229
Enabling Dynamic DNS	229
In the AOS-W Instant UI	229
In the CLI:	230
Configuring Dynamic DNS Updates for Clients	230
In the CLI	231
Verifying the Configuration	231
VPN Configuration	232
Understanding VPN Features	232
Supported VPN Protocols	233
Configuring a Tunnel from an OAW-IAP to a Mobility Controller	233
Configuring an IPSec Tunnel	234
In the AOS-W Instant UI	234
In the CLI	235
Example	235
Configuring an L2-GRE Tunnel	235
Configuring Manual GRE Parameters	235
In the AOS-W Instant UI	236
In the CLI	236
Configuring Alcatel-Lucent GRE Parameters	237
In the AOS-W Instant UI	237
In the CLI	238
Configuring an L2TPv3 Tunnel	238
In the AOS-W Instant UI	239

In the CLI	241
Example	241
Configuring Routing Profiles	244
In the AOS-W Instant UI	244
In the CLI	245
IAP-VPN Deployment	246
Understanding IAP-VPN Architecture	246
IAP-VPN Scalability Limits	246
IAP-VPN Forwarding Modes	247
Local Mode	247
Local L2 Mode	247
Local L3 Mode	247
Distributed L2 Mode	248
Distributed L3 Mode	248
Centralized L2 Mode	248
Centralized L3 Mode	248
DHCP Scope and VPN Forwarding Modes Mapping	249
Configuring OAW-IAP and Switch for IAP-VPN Operations	249
Configuring an OAW-IAP Network for IAP-VPN Operations	249
Defining the VPN host settings	250
Configuring Routing Profiles	250
Configuring DHCP Profiles	250
Configuring an SSID or Wired Port	251
Enabling Dynamic RADIUS Proxy	251
Configuring Enterprise Domains	251
Configuring a Switch for IAP-VPN Operations	251
OSPF Configuration	252
VPN Configuration	253
Whitelist Database Configuration	253
VPN Local Pool Configuration	254
Role Assignment for the Authenticated OAW-IAPs	254
VPN Profile Configuration	254
Branch-ID Allocation	254
Branch Status Verification	255
Example	255

Adaptive Radio Management	257
ARM Overview	257
Channel or Power Assignment	257
Voice Aware Scanning	257
Load Aware Scanning	257
Monitoring the Network with ARM	257
ARM Metrics	257
Configuring ARM Features on an OAW-IAP	258
Band Steering	258
In the AOS-W Instant UI	258
In the CLI	258
Airtime Fairness Mode	259
In the AOS-W Instant UI	259
In the CLI	259
Client Match	259
In the AOS-W Instant UI	260
In the CLI	261
Access Point Control	261
In the AOS-W Instant UI	261
In the CLI	263
Verifying ARM Configuration	263
Configuring Radio Settings	264
In the AOS-W Instant UI	264
In the CLI	265
Configuring Cell Size Reduction using the CLI	267
Deep Packet Inspection and Application Visibility	268
Deep Packet Inspection	268
Enabling Application Visibility	268
In the AOS-W Instant UI	268
In the CLI	269
Application Visibility	269
Application Category Charts	269
Application Charts	271
Web Categories Charts	272

Web Reputation Charts	273
Enabling URL Visibility	274
In the AOS-W Instant UI	274
In the CLI	274
Configuring ACL Rules for Application and Application Categories	274
In the AOS-W Instant UI	274
In the CLI	277
Example	277
Configuring Web Policy Enforcement Service	277
In the AOS-W Instant UI	277
In the CLI	279
Example	279
Voice and Video	280
Wi-Fi Multimedia Traffic Management	280
Configuring WMM for Wireless Clients	281
In the AOS-W Instant UI	281
In the CLI	281
Mapping WMM ACs and DSCP Tags	281
In the AOS-W Instant UI	282
In the CLI	282
Configuring WMM U-APSD	282
QoS for Microsoft Office Lync	283
Microsoft Office Lync	283
Services	284
AirGroup Configuration	284
Multicast DNS and Bonjour® Services	285
DLNA UPnP Support	286
AirGroup Features	287
AirGroup Services	288
AirGroup Components	289
ClearPass Policy Manager and ClearPass Guest Features	289
Configuring AirGroup and AirGroup Services on an OAW-IAP	290
In the AOS-W Instant UI	290
In the CLI	291

Configuring AirGroup and ClearPass Policy Manager interface in AOS-W Instant	292
Creating a RADIUS Server	292
Assign a Server to AirGroup	292
Configure ClearPass Policy Manager to Enforce Registration	292
Change of Authorization (CoA)	292
Configuring an OAW-IAP for RTLS Support	292
In the AOS-W Instant UI	293
In the CLI	293
Configuring an OAW-IAP for Analytics and Location Engine Support	294
ALE with AOS-W Instant	294
Enabling ALE Support on an OAW-IAP	294
In the AOS-W Instant UI	294
In the CLI	295
Verifying ALE Configuration on an OAW-IAP	295
Managing BLE Beacons	295
In the AOS-W Instant UI	296
In the CLI	296
Configuring OpenDNS Credentials	296
In the AOS-W Instant UI	296
In the CLI	297
Integrating an OAW-IAP with Palo Alto Networks Firewall	297
Integration with AOS-W Instant	297
Configuring an OAW-IAP for PAN integration	297
In the AOS-W Instant UI	297
In the CLI	298
Integrating an OAW-IAP with an XML API interface	298
Integration with AOS-W Instant	299
Configuring an OAW-IAP for XML API integration	299
In the AOS-W Instant UI	299
In the CLI	299
Creating an XML API Request	299
CALEA Integration and Lawful Intercept Compliance	301
CALEA Server Integration	301
Traffic Flow from OAW-IAP to CALEA Server	302

Traffic Flow from OAW-IAP to CALEA Server through VPN	302
Client Traffic Replication	303
Configuring an OAW-IAP for CALEA Integration	303
Creating a CALEA Profile	303
In the AOS-W Instant UI	304
In the CLI	304
Creating an Access Rule for CALEA	304
In the AOS-W Instant UI	304
In the CLI	304
Verifying the configuration	305
Example	305
OAW-IAP Management and Monitoring	307
Managing an OAW-IAP from OmniVista	307
Image Management	307
Resetting an OAW-IAP	307
OAW-IAP and Client Monitoring	307
Template-based Configuration	308
Trending Reports	308
Intrusion Detection System	308
Wireless Intrusion Detection System (WIDS) Event Reporting to OmniVista	308
RF Visualization Support for AOS-W Instant	309
PSK-based and Certificate-based Authentication	309
Configurable Port for OAW-IAP and OmniVista Management Server Communication	309
Configuring Organization String	310
Shared Key	310
Configuring OmniVista Information	310
In the AOS-W Instant UI	310
In the CLI	310
Example	310
Configuring for OmniVista Discovery through DHCP	311
Enabling DNS-based Discovery of the Provisioning AMP server	311
Standard DHCP option 60 and 43 on Windows Server 2008	311
Alternate Method for Defining Vendor-Specific DHCP Options	316
Uplink Configuration	318
Uplink Interfaces	318

Ethernet Uplink	318
Configuring PPPoE Uplink Profile	319
In the AOS-W Instant UI	319
In the CLI	320
Cellular Uplink	320
Configuring Cellular Uplink Profiles	323
In the AOS-W Instant UI	323
In the CLI	324
Managing Cellular SIM PIN	324
Wi-Fi Uplink	325
Configuring a Wi-Fi Uplink Profile	325
In the AOS-W Instant UI	325
In the CLI	326
Uplink Preferences and Switching	326
Enforcing Uplinks	326
In the AOS-W Instant UI	327
In the CLI	327
Setting an Uplink Priority	327
In the AOS-W Instant UI	327
In the CLI	327
Enabling Uplink Preemption	327
In the AOS-W Instant UI	328
In the CLI	328
Switching Uplinks Based on VPN and Internet Availability	328
Switching Uplinks Based on VPN Status	328
Switching Uplinks Based on Internet Availability	328
In the AOS-W Instant UI	329
In the CLI	329
Viewing Uplink Status and Configuration	329
Intrusion Detection	331
Detecting and Classifying Rogue APs	331
OS Fingerprinting	331
Configuring Wireless Intrusion Protection and Detection Levels	332
Containment Methods	336
Configuring IDS Using CLI	337

Mesh OAW-IAP Configuration	339
Mesh Network Overview	339
Mesh OAW-IAPs	339
Mesh Portals	339
Mesh Points	340
Setting up AOS-W Instant Mesh Network	340
Configuring Wired Bridging on Ethernet 0 for Mesh Point	340
In the AOS-W Instant UI	341
In the CLI	341
Mobility and Client Management	342
Layer-3 Mobility Overview	342
Configuring L3-Mobility	343
Home Agent Load Balancing	343
Configuring a Mobility Domain for AOS-W Instant	343
In the AOS-W Instant UI	343
In the CLI	344
Spectrum Monitor	345
Understanding Spectrum Data	345
Device List	345
Non Wi-Fi Interferers	347
Channel Details	348
Channel Metrics	349
Spectrum Alerts	350
Configuring Spectrum Monitors and Hybrid OAW-IAPs	351
Converting an OAW-IAP to a Hybrid OAW-IAP	351
In the AOS-W Instant UI	351
In the CLI	351
Converting an OAW-IAP to a Spectrum Monitor	351
In the AOS-W Instant UI	351
In the CLI	352
OAW-IAP Maintenance	353
Upgrading an OAW-IAP	353
Upgrading an OAW-IAP and Image Server	353

Image Management Using OmniVista	353
Image Management Using Cloud Server	353
Configuring HTTP Proxy on an OAW-IAP	353
In the AOS-W Instant UI	354
In the CLI	354
Upgrading an OAW-IAP Using Automatic Image Check	354
Upgrading to a New Version Manually	355
Upgrading an Image Using CLI	355
Backing up and Restoring OAW-IAP Configuration Data	356
Viewing Current Configuration	356
Backing up Configuration Data	356
Restoring Configuration	356
Converting an OAW-IAP to a Remote AP and Campus AP	357
Regulatory Domain Restrictions for OAW-IAP to RAP or CAP Conversion	357
Converting an OAW-IAP to a Remote AP	359
Converting an OAW-IAP to a Campus AP	361
Converting an OAW-IAP to Standalone Mode	362
Converting an OAW-IAP using CLI	363
Resetting a Remote AP or Campus AP to an OAW-IAP	363
Rebooting the OAW-IAP	363
Monitoring Devices and Logs	365
Configuring SNMP	365
SNMP Parameters for OAW-IAP	365
Configuring SNMP	366
Creating community strings for SNMPv1 and SNMPv2 Using AOS-W Instant UI	366
Creating community strings for SNMPv3 Using AOS-W Instant UI	367
Configuring SNMP Community Strings in the CLI	368
Configuring SNMP Traps	368
In the AOS-W Instant UI	368
In the CLI	369
Configuring a Syslog Server	369
In the AOS-W Instant UI	369
In the CLI	371
Configuring TFTP Dump Server	371

In the AOS-W Instant UI	371
In the CLI	371
Running Debug Commands from the UI	372
Uplink Bandwidth Monitoring	376
Hotspot Profiles	377
Understanding Hotspot Profiles	377
Generic Advertisement Service (GAS)	377
Access Network Query Protocol (ANQP)	378
Hotspot 2.0 Query Protocol (H2QP)	378
Information Elements (IEs) and Management Frames	378
NAI Realm List	379
Configuring Hotspot Profiles	379
Creating Advertisement Profiles for Hotspot Configuration	379
Configuring an NAI Realm Profile	379
Configuring a Venue Name Profile	381
Configuring a Network Authentication Profile	384
Configuring a Roaming Consortium Profile	384
Configuring a 3GPP Profile	384
Configuring an IP Address Availability Profile	385
Configuring a Domain Profile	385
Configuring an Operator-friendly Profile	385
Configuring a Connection Capability Profile	385
Configuring an Operating Class Profile	385
Configuring a WAN Metrics Profile	386
Creating a Hotspot Profile	386
Associating an Advertisement Profile to a Hotspot Profile	388
Creating a WLAN SSID and Associating Hotspot Profile	389
Sample Configuration	390
ClearPass Guest Setup	392
Testing	395
Troubleshooting	395
IAP-VPN Deployment Scenarios	396
Scenario 1—IPSec: Single Datacenter Deployment with No Redundancy	397

Topology	397
AP Configuration	397
AP Connected Switch Configuration	399
Datacenter Configuration	400
Scenario 2—IPSec: Single Datacenter with Multiple Switches for Redundancy	401
Topology	401
AP Configuration	402
AP Connected Switch Configuration	404
Datacenter Configuration	404
Scenario 3—IPSec: Multiple Datacenter Deployment with Primary and Backup Switches for Redundancy	405
Topology	405
AP Configuration	406
AP Connected Switch Configuration	409
Datacenter Configuration	409
Scenario 4—GRE: Single Datacenter Deployment with No Redundancy	410
Topology	410
AP Configuration	411
AP Connected Switch Configuration	413
Datacenter Configuration	413
Glossary	413
Terminology	418
Acronyms and Abbreviations	418
Glossary	419

This User Guide describes the features supported by AOS-W Instant and provides detailed instructions for setting up and configuring the AOS-W Instant network.

Intended Audience

This guide is intended for administrators who configure and use OAW-IAPs.

Related Documents

In addition to this document, the AOS-W Instant product documentation includes the following:

- *AOS-W Instant Access Point Installation Guides*
- *AOS-W Instant Quick Start Guide*
- *AOS-W Instant CLI Reference Guide*
- *AOS-W Instant MIB Reference Guide*
- *AOS-W Instant Syslog Messages Reference Guide*
- *AOS-W Instant Release Notes*

Conventions

The following conventions are used throughout this manual to emphasize important concepts:

Table 1: *Typographical Conventions*

Style Type	Description
<i>Italics</i>	This style is used to emphasize important terms and to mark the titles of books.
System items	This fixed-width font depicts the following: <ul style="list-style-type: none">• Sample screen output• System prompts• Filenames, software devices, and specific commands when mentioned in the text.
Commands	In the command examples, this style depicts the keywords that must be typed exactly as shown.

Style Type	Description
<Arguments>	In the command examples, italicized text within angle brackets represents items that you should replace with information appropriate to your specific situation. For example: # send <text message> In this example, you would type “send” at the system prompt exactly as shown, followed by the text of the message you wish to send. Do not type the angle brackets.
[Optional]	Command examples enclosed in brackets are optional. Do not type the brackets.
{Item A Item B}	In the command examples, items within curled braces and separated by a vertical bar represent the available choices. Enter only one choice. Do not type the braces or bars.

The following informational icons are used throughout this guide:



Indicates helpful suggestions, pertinent information, and important things to remember.



Indicates a risk of damage to your hardware or loss of data.



Indicates a risk of personal injury or death.

Contacting Support

Table 2: Support Information

Contact Center Online	
• Main Site	http://www.alcatel-lucent.com/enterprise
• Support Site	https://service.esd.alcatel-lucent.com
• Email	esd.support@alcatel-lucent.com
Service & Support Contact Center Telephone	
• North America	1-800-995-2696
• Latin America	1-877-919-9526
• EMEA	+800 00200100 (Toll Free) or +1-650-385-2193
• Asia Pacific	+65 6240 8484
• Worldwide	1-818-878-4507

This chapter provides the following information:

- [AOS-W Instant Overview](#)
- [What is New in this Release](#)

AOS-W Instant Overview

AOS-W Instant virtualizes Alcatel-Lucent OmniAccess WLAN Switch capabilities on 802.11 access points (APs), creating a feature-rich enterprise-grade wireless LAN (WLAN) that combines affordability and configuration simplicity.

AOS-W Instant is a simple, easy to deploy turn-key WLAN solution consisting of one or more APs. An Ethernet port with routable connectivity to the Internet or a self-enclosed network is used for deploying an Instant Wireless Network. An Instant Access Point (OAW-IAP) can be installed at a single site or deployed across multiple geographically-dispersed locations. Designed specifically for easy deployment, and proactive management of networks, AOS-W Instant is ideal for small customers or remote locations without any on-site IT administrator.

AOS-W Instant consists of an OAW-IAP and a Virtual Controller. The Virtual Controller resides within one of the APs. In an AOS-W Instant deployment scenario, only the first OAW-IAP needs to be configured. After the first OAW-IAP is configured, the other OAW-IAPs inherit all the required configuration information from the Virtual Controller. AOS-W Instant continually monitors the network to determine the OAW-IAP that should function as the Virtual Controller at any time, and the Virtual Controller will move from one OAW-IAP to another as necessary without impacting network performance.

Supported AP Platforms

The following table provides a list of AP platforms that support Instant software:

Table 3: *Supported AP Platforms*

OAW-IAP Platform	Minimum AOS-W Instant Version
IAP-324/325	6.4.4.3-4.2.2.0 or later
OAW-IAP205H OAW-IAP228 OAW-IAP277	6.4.3.1-4.2.0.0 or later
OAW-IAP204/205 OAW-IAP214/215	6.4.2.0-4.1.1.0 or later
OAW-IAP103 OAW-IAP274/275	6.4.0.2-4.1.0.0 or later
OAW-IAP114/115	6.3.1.1-4.0.0.0 or later

OAW-IAP Platform	Minimum AOS-W Instant Version
OAW-IAP224/225	
OAW-RAP155/155P	6.2.1.0-3.3.0.0 or later
OAW-RAP108/109	6.2.0.0-3.2.0.0 or later
OAW-RAP3WN/3WNP	6.1.3.1-3.0.0.0 or later
OAW-IAP-104	6.1.3.1-3.0.0.0 or later
OAW-IAP175AC/175P	6.1.3.1-3.0.0.0 or later
OAW-IAP134/135	6.1.2.3-2.0.0.0 or later
OAW-IAP105	5.0.3.0-1.0.0.0 or later
OAW-IAP92/93	5.0.3.0-1.0.0.0 to 6.4.2.0-4.1.1.0

Each OAW-IAP model has a minimum required version as shown in [Table 3](#). When a new OAW-IAP is added into an existing cluster, it can join the cluster only if the existing cluster is running at least the minimum required version of that AP. If the existing cluster is running a version below the minimum required version of the new AP, new AP will not come up and may reboot with the reason **Image sync fail**. To recover from this condition, upgrade the existing cluster to at least the minimum required version of the new AP first, and add the new AP.



Alcatel-Lucent recommends that networks with more than 128 APs be designed as multiple, smaller virtual-controller networks with Layer-3 mobility enabled between these networks.

Alcatel-Lucent OAW-IAPs are available in the following variants:

- US (United States)
- RW (Unrestricted Regulatory Domain)
- JP (Japan)
- ILIS (Israel)

The following table provides the variants supported for each OAW-IAP platform:

Table 4: Supported OAW-IAP Variants

OAW-IAP Model (Reg Domain)	OAW-IAP###-US (US only)	OAW-IAP###-JP (Japan only)	OAW-IAP-###-RW (Worldwide except US/JP/IS)	OAW-IAP-### (Worldwide except US and Japan)
IAP-324/325	Yes	Yes	Yes	Yes
OAW-IAP277	Yes	Yes	Yes	No
OAW-IAP228	Yes	Yes	Yes	No
OAW-IAP205H	Yes	Yes	Yes	No
OAW-IAP204/205	Yes	Yes	Yes	No
OAW-IAP214/215	Yes	Yes	Yes	No
OAW-IAP274/275	Yes	Yes	Yes	No
OAW-IAP224/225	Yes	Yes	No	No
OAW-IAP114/115	Yes	Yes	No	No
OAW-IAP103	Yes	Yes	Yes	No
OAW-IAP175P/175AC	Yes	Yes	No	Yes
OAW-IAP134/135	Yes	Yes	No	Yes
OAW-RAP108/109	Yes	Yes	No	Yes
OAW-RAP155/155P	Yes	Yes	No	Yes
OAW-RAP3WN/3WNP	Yes	Yes	No	Yes
OAW-IAP104/105	Yes	Yes	No	Yes

For information on regulatory domains and the list of countries supported by the OAW-IAP-RW type, see [Country Code on page 36](#).

AOS-W Instant UI

The AOS-W Instant User Interface (UI) provides a standard web-based interface that allows you to configure and monitor a Wi-Fi network. AOS-W Instant is accessible through a standard web browser from a remote management console or workstation and can be launched using the following browsers:

- Microsoft Internet Explorer 11 or earlier
- Apple Safari 6.0 or later
- Google Chrome 23.0.1271.95 or later
- Mozilla Firefox 17.0 or later

If the AOS-W Instant UI is launched through an unsupported browser, a warning message is displayed along with a list of recommended browsers. However, the users are allowed to login using the **Continue login** link on the **Login** page.



To view the AOS-W Instant UI, ensure that the JavaScript is enabled on the web browser.

The AOS-W Instant UI logs out automatically if the window is inactive for 15 minutes.

AOS-W Instant CLI

The AOS-W Instant Command Line Interface (CLI) is a text-based interface accessible through a Secure Shell (SSH) session.

SSH access requires that you configure an IP address and a default gateway on the OAW-IAP and connect the OAW-IAP to your network. This is typically performed when the AOS-W Instant network on an OAW-IAP is set up.

What is New in this Release

The following features were introduced in AOS-W Instant 6.4.4.4-4.2.3.0:

Table 5: *New Features*

Feature	Description
802.1X Supplicant Configuration Support for Wired Networks	OAW-IAPs can now be provisioned as 802.1X supplicant for networks where all wired devices are required to authenticate using PEAP or TLS protocol. If the ports, to which the OAW-IAPs are connected, are configured to use the 802.1X authentication method, ensure that you configure the OAW-IAPs to function as an 802.1X client or supplicant and configure the 802.1X authentication type on the uplink ports of the OAW-IAP.
Enabling or disabling SSIDs based on out of service states	You can now enable or disable an SSID based on the following out of service states of the OAW-IAP: <ul style="list-style-type: none">• VPN down• Uplink down• Internet down• Primary uplink down The network will be out of service when the selected event occurs and the SSID is enabled or disabled as per the configuration settings applied.
Dynamic DNS Registration	AOS-W Instant now supports dynamically updating DNS records of the OAW-IAP and its clients on to the DNS server. You can also configure dynamic dns when creating

Table 5: New Features

Feature	Description
Support	Distributed, L3 DHCP scopes and send DNS updates periodically to the DNS server.
<ol style="list-style-type: none"> 1. Full URL Visibility 2. Enforcement Visualization 3. Application Visibility 	<p>AOS-W Instant now supports the extraction of full URL from the http or https sessions and periodically logs them on the ALE server.</p> <p>AOS-W Instant 6.4.4.4-4.2.3 also supports viewing of blocked and allowed DPI and Web Content.</p> <p>The application DPI and Web Content graphs can now be viewed individually.</p>
Configure-Only Mode in AMP	The latest version of OmniVista includes a new option which sets the OAW-IAP in the config-only mode.
BLE beacon management and operation mode configuration	In AOS-W Instant 6.4.4.4-4.2.3.0, OAW-IAPs support Alcatel-Lucent Bluetooth Low Energy (BLE) devices, such as BT-100 and BT-105, which are used for location tracking and proximity detection. The BLE devices connected to an OAW-IAP can be monitored or managed by a cloud based Beacon Management Console (BMC). The BLE beacon management feature allows you to configure parameters for managing the BLE beacons and establishing secure communication with the Beacon Management Console (BMC). You can also configure the BLE operation modes that determine the functions of the built-in BLE chip in the OAW-IAP.
Static LACP Configuration Support	Static LACP configuration is a new Per-AP setting which allows you to enable, disable, and remove the static LACP configuration in OAW-IAPs. The static LACP mode is supported on OAW-IAP225, OAW-IAP275, and IAP-325 access points.
Per-AP SSID and VLAN	The Per-AP SSID and VLAN is a new setting which allows you to set the environment variables, per_ap_ssid and per_ap_vlan on a wireless profile.
New Wired-Containment Knobs for NAT Rogue	This feature introduces two new wired-containment knobs, wired-containment-ap-adj-mac and wired-containment-susp-l3-rogue . These knobs enable the protection of the wired-containment for NAT rogue.
Maximum clients for radio profiles	A new per-ap setting is added to set the maximum number of clients that can connect to the 5 GHz and 2.4 GHz radio profiles.
Custom Port for Speed Test	The users can now define a custom server port for the speed test.

This chapter describes the following procedures:

- [Setting up AOS-W Instant Network on page 34](#)
- [Logging in to the AOS-W Instant UI on page 36](#)
- [Accessing the AOS-W Instant CLI on page 38](#)

Setting up AOS-W Instant Network

Before installing an OAW-IAP:

- Ensure that you have an Ethernet cable of the required length to connect an OAW-IAP to the home router.
- Ensure that you have one of the following power sources:
 - IEEE 802.3af/at-compliant Power over Ethernet (PoE) source. The PoE source can be any power source equipment (PSE) switch or a midspan PSE device.
 - OAW-IAP power adapter kit.

Perform the following procedures to set up the AOS-W Instant network:

1. [Connecting an OAW-IAP on page 34](#)
2. [Assigning an IP address to the OAW-IAP on page 34](#)
3. [Connecting to a Provisioning Wi-Fi Network on page 35](#)
4. [Provisioning OAW-IAPs through OmniVista on page 36](#)

Connecting an OAW-IAP

Based on the type of the power source used, perform one of the following steps to connect an OAW-IAP to the power source:

- PoE switch— Connect the ENET 0 port of the OAW-IAP to the appropriate port on the PoE switch.
- PoE midspan— Connect the ENET 0 port of the OAW-IAP to the appropriate port on the PoE midspan.
- AC to DC power adapter— Connect the 12V DC power jack socket to the AC to DC power adapter.



OAW-RAP155P supports PSE for 802.3at powered device (class 0-4) on one port (E1 or E2), or 802.3af powered DC IN (Power Socket) on two ports (E1 and E2).

Assigning an IP address to the OAW-IAP

The OAW-IAP needs an IP address for network connectivity. When you connect an OAW-IAP to a network, it receives an IP address from a DHCP server.

To obtain an IP address for an OAW-IAP:

1. Ensure that the DHCP service is enabled on the network.
2. Connect the ENET 0 port of OAW-IAP to a switch or router using an Ethernet cable.
3. Connect the OAW-IAP to a power source. The OAW-IAP receives an IP address provided by the switch or router.



If there is no DHCP service on the network, the OAW-IAP can be assigned a static IP address. If a static IP is not assigned, the OAW-IAP obtains an IP automatically within the 169.254 subnet.

Assigning a Static IP

To assign a static IP to an OAW-IAP:

1. Connect a terminal, PC, or workstation running a terminal emulation program to the **Console** port on the OAW-IAP.
2. Power on the OAW-IAP. An autoboot countdown prompt that allows you to interrupt the normal startup process and access **apboot** is displayed.
3. Click **Enter** before the timer expires. The OAW-IAP goes into the **apboot** mode.
4. In the **apboot** mode, use the following commands to assign a static IP to the OAW-IAP.

```
Hit <Enter> to stop autoboot: 0
apboot>
apboot> setenv ipaddr 192.0.2.0
apboot> setenv netmask 255.255.255.0
apboot> setenv gatewayip 192.0.2.2
apboot> save
Saving Environment to Flash...
Un-Protected 1 sectors
.done
Erased 1 sectors
Writing
```

5. Use the **printenv** command to view the configuration.

```
apboot> printenv
```

Connecting to a Provisioning Wi-Fi Network

The OAW-IAPs boot with factory default configuration and try to provision automatically. If the automatic provisioning is successful, the **instant** SSID will not be available. If OmniVista and Activate are not reachable and the automatic provisioning fails, the **instant** SSID becomes available and the users can connect to a provisioning network by using the instant SSID.

To connect to a provisioning Wi-Fi network:

1. Ensure that the client is not connected to any wired network.
2. Connect a wireless enabled client to a provisioning Wi-Fi network: for example, **instant**.
3. If the Windows OS system is used:
 - a. Click the wireless network connection icon in the system tray. The **Wireless Network Connection** window is displayed.
 - b. Click on the **instant** network and then click **Connect**.
4. If the Mac OS system is used:
 - a. Click the **AirPort** icon. A list of available Wi-Fi networks is displayed.
 - b. Click on the **instant** network.



The **instant** SSIDs are broadcast in 2.4 GHz only.

OAW-IAP Cluster

OAW-IAPs in the same VLAN automatically find each other and form a single functioning network managed by a Virtual Controller.



Moving an OAW-IAP from one cluster to another requires a factory reset of the OAW-IAP.

Disabling the Provisioning Wi-Fi Network

The provisioning network is enabled by default. AOS-W Instant provides the option to disable the provisioning network through the console port. Use this option only when you do not want the default SSID **instant** to be broadcast in your network.

To disable the provisioning network:

1. Connect a terminal or PC/workstation running a terminal emulation program to the **Console** port on the OAW-IAP.
2. Configure the terminal or terminal emulation program to use the following communication settings:

Table 6: *Terminal Communication Settings*

Baud Rate	Data Bits	Parity	Stop Bits	Flow Control
9600	8	None	1	None

3. Power on the OAW-IAP. An autoboot countdown prompt that allows you to interrupt the normal startup process and access apboot is displayed.
4. Click **Enter** before the timer expires. The OAW-IAP goes into the apboot mode through console.
5. In the apboot mode, use the following commands to disable the provisioning network:
 - apboot> factory_reset
 - apboot> setenv disable_prov_ssid 1
 - apboot> saveenv
 - apboot> reset

Provisioning OAW-IAPs through OmniVista

For information on provisioning OAW-IAPs through OmniVista, see the *OmniVista Deployment Guide*.

Logging in to the AOS-W Instant UI

Launch a web browser and enter <http://instant.Alcatel-Lucentnetworks.com>. In the login screen, enter the following credentials:

- Username— admin
- Password— admin

The following figure shows the **Login** screen:

Figure 1 Login Screen

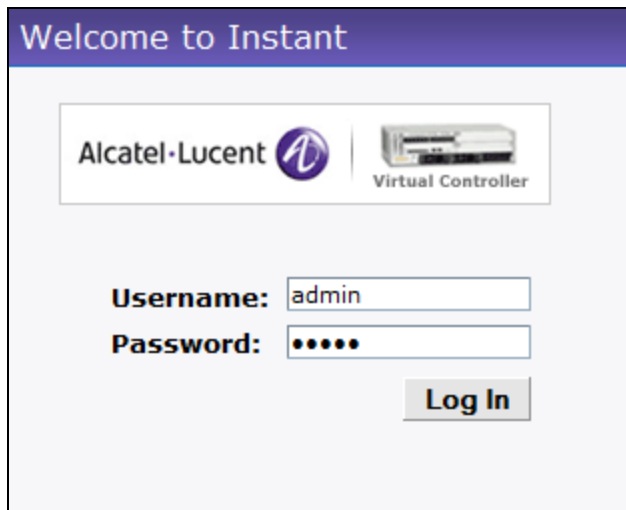

Welcome to Instant

Alcatel-Lucent Virtual Controller

Username: admin

Password: ●●●●●●

Log In

When you use a provisioning Wi-Fi network to connect to the Internet, all browser requests are directed to the AOS-W Instant UI. For example, if you enter www.example.com in the address field, you are directed to the AOS-W Instant UI. You can change the default login credentials after the first login.

Regulatory Domains

The IEEE 802.11/b/g/n Wi-Fi networks operate in the 2.4 GHz spectrum and IEEE 802.11 a/n operates in the 5.0 GHz spectrum. The spectrum is divided into channels. The 2.4 GHz spectrum is divided into 14 overlapping, staggered 20 MHz wireless carrier channels. These channels are spaced 5 MHz apart. The 5 GHz spectrum is divided into more channels. The channels that can be used in a particular country differ based on the regulations of that country.

The initial Wi-Fi setup requires you to specify the country code for the country in which the AOS-W Instant operates. This configuration sets the regulatory domain for the radio frequencies that the OAW-IAPs use. Within the regulated transmission spectrum, a high-throughput 802.11 ac, 802.11 a, 802.11 b/g, or 802.11 n radio setting can be configured. The available 20 MHz, 40 MHz, or 80MHz channels are dependent on the specified country code.

You cannot change the country code for the OAW-IAPs in the restricted regulatory domains such as US, Japan, and Israel for most of the OAW-IAP models. For OAW-IAP-RW variants, you can select from the list of supported regulatory domains. If the supported country code is not in the list, contact your Alcatel-Lucent Support team to know if the required country code is supported and obtain the software that supports the required country code.



Improper country code assignments can disrupt wireless transmissions. Most countries impose penalties and sanctions on operators of wireless networks with devices set to improper country codes.

To view the country code information, run the **show country-codes** command.

Specifying Country Code



This procedure is applicable only to the OAW-IAP-RW variants. Skip this step if you are installing OAW-IAP in the United States, Japan, or Israel.

The **Country Code** window is displayed for the OAW-IAP-RW variants when you log in to the OAW-IAP UI for the first time. The **Please Specify the Country Code** drop-down list displays only the supported country codes. If the OAW-IAP cluster consists of multiple AP platforms, the country codes supported by the master OAW-IAP is displayed for all other APs in the cluster. Select a country code from the list and click **OK**. The OAW-IAP operates in the selected country code domain.

Figure 2 *Specifying a Country Code*



You can also view the list of supported country codes for the OAW-IAP-RW variants using the **show country-codes** command.

Accessing the AOS-W Instant CLI

AOS-W Instant supports the use of Command Line Interface (CLI) for scripting purposes. When you make configuration changes on a master OAW-IAP in the CLI, all associated OAW-IAPs in the cluster inherit these changes and subsequently update their configurations. By default, you can access the CLI from the serial port or from an SSH session. You must explicitly enable Telnet access on the OAW-IAP to access the CLI through a Telnet session.

For information on enabling SSH and Telnet access to the OAW-IAP CLI, see [Terminal access on page 77](#).

Connecting to a CLI Session

On connecting to a CLI session, the system displays its host name followed by the login prompt. Use the administrator credentials to start a CLI session. For example:

```
(Instant AP)
User: admin
```

If the login is successful, the privileged command mode is enabled and a command prompt is displayed. For example:

```
(Instant AP) #
```

The privileged mode provides access to **show**, **clear**, **ping**, **traceroute**, and **commit** commands. The configuration commands are available in `config` mode. To move from privileged mode to the configuration mode, enter the following command at the command prompt:

```
(Instant AP) # configure terminal
```

The `configure terminal` command allows you to enter the basic configuration mode and the command prompt is displayed as follows:

```
(Instant AP) (config) #
```

The AOS-W Instant CLI allows CLI scripting in several other sub-command modes to allow the users to configure individual interfaces, SSIDs, access rules, and security settings.

You can use the question mark (?) to view the commands available in a privileged mode, configuration mode, or sub-mode.



Although automatic completion is supported for some commands such as **configure terminal**, the complete **exit** and **end** commands must be entered at command prompt.

Applying Configuration Changes

Each command processed by the Virtual Controller is applied on all the slaves in a cluster. The changes configured in a CLI session are saved in the CLI context. The CLI does not support the configuration data exceeding the 4K buffer size in a CLI session. Therefore, Alcatel-Lucent recommends that you configure fewer changes at a time and apply the changes at regular intervals.

To apply and save the configuration changes at regular intervals, use the following command in the privileged mode:

```
(Instant AP)# commit apply
```

To apply the configuration changes to the cluster without saving the configuration, use the following command in the privileged mode:

```
(Instant AP)# commit apply no-save
```

To view the changes that are yet to be applied, use the following command in the privileged mode:

```
(Instant AP)# show uncommitted-config
```

To revert to the earlier configuration, use the following command in the privileged mode.

```
(Instant AP)# commit revert
```

Example:

```
(Instant AP) (config)# rf dot11a-radio-profile
(Instant AP) (RF dot11a Radio Profile)# beacon-interval 200
(Instant AP) (RF dot11a Radio Profile)# no legacy-mode
(Instant AP) (RF dot11a Radio Profile)# dot11h
(Instant AP) (RF dot11a Radio Profile)# interference-immunity 3
(Instant AP) (RF dot11a Radio Profile)# csa-count 2
(Instant AP) (RF dot11a Radio Profile)# spectrum-monitor
(Instant AP) (RF dot11a Radio Profile)# end
```

```
(Instant AP)# show uncommitted-config
  rf dot11a-radio-profile
  no legacy-mode
  beacon-interval 200
  no dot11h
  interference-immunity 3
  csa-count 1
  no spectrum-monitor
```

```
Instant Access Point# commit apply
```

Using Sequence Sensitive Commands

The AOS-W Instant CLI does not support positioning or precedence of sequence-sensitive commands. Therefore, Alcatel-Lucent recommends that you remove the existing configuration before adding or modifying the configuration details for sequence-sensitive commands. You can either delete an existing profile or remove a specific configuration by using the **no...** commands.

The following table lists the sequence-sensitive commands and the corresponding **no** command to remove the configuration.

Table 7: Sequence-Sensitive Commands

Sequence-Sensitive Command	Corresponding no command
opendns <username <password>	no opendns
rule <dest> <mask> <match> <protocol> <start-port> <end-port> {permit deny src-nat dst-nat {<IP-address> <port> <port>}}[<option1...option9>]	no rule <dest> <:mask> <match> <protocol> <start-port> <end-port> {permit deny src-nat dst-nat}
mgmt-auth-server <auth-profile-name>	no mgmt-auth-server <auth-profile-name>
set-role <attribute>{{equals not-equals starts-with ends-with contains} <operator> <role> value-of}	no set-role <attribute>{{equals not-equals starts-with ends-with contains} <operator> value-of} no set-role
set-vlan <attribute>{{equals not-equals starts-with ends-with contains} <operator> <VLAN-ID> value-of}	no set-vlan <attribute>{{equals not-equals starts-with ends-with contains} <operator> value-of} no set-vlan
auth-server <name>	no auth-server <name>

This section provides the following information

- [Managed Mode Operations](#)
- [Pre-requisites](#)
- [Configuring Managed Mode Parameters](#)
- [Verifying the Configuration](#)

Managed Mode Operations

OAW-IAPs support managed mode operations to retrieve the configuration file from a server through the File Transfer Protocol (FTP) or FTP over Secure Sockets Layer (FTPS), and automatically update the OAW-IAP configuration.

The server details for retrieving configuration files are stored in the basic configuration of the APs. The basic configuration of an AP includes settings specific to an AP, for example, hostname, static IP, and radio configuration settings. When an AP boots up, it performs a GET operation to retrieve the configuration (.cfg) file from the associated server using the specified download method.

After the initial configuration is applied to the APs, the configuration can be changed at any point. You can configure a polling mechanism to fetch the latest configuration by using an FTP or FTPS client periodically. If the remote configuration is different from the one running on the OAW-IAP and if a difference in the configuration file is detected by the OAW-IAP, the new configuration is applied. At any given time, APs can fetch only one configuration file, which may include the configuration details specific to an AP. For configuring polling mechanism and downloading configuration files, the users are required to provide credentials (username and password). However, if automatic mode is enabled, the user credentials required to fetch the configuration file are automatically generated. To enable automatic configuration of the OAW-IAPs, configure the management mode command parameters.

Pre-requisites

Perform the following checks before the configuring management mode command parameters:

- Ensure that the OAW-IAP is running 6.2.1.0-3.4 or later release version.
- When the OAW-IAPs are in the management mode, ensure that the OAW-IAPs are not managed by OmniVista.

Configuring Managed Mode Parameters

To enable the automatic configuration, perform the steps described in the following table:

Table 8: *Managed Mode Commands*

Steps	Command
1. Start a CLI session to configure the managed-mode profile for automatic configuration.	<code>(Instant AP) (config) # managed-mode-profile</code>
2. Enable automatic configuration Or Specify the user credentials.	<code>(Instant AP) (managed-mode-profile) # automatic</code> Or <code>(Instant AP) (managed-mode-profile) # username <username></code> <code>(Instant AP) (managed-mode-profile) # password <password></code> NOTE: If the automatic mode is enabled, the user credentials are automatically generated based on AP MAC address.
3. Specify the configuration file.	<code>(Instant AP) (managed-mode-profile) # config-filename <file_name></code> Filename— Indicates filename within the alphanumeric format. Ensure that configuration file name does not exceed 40 characters.
4. Specify the configuration file download method.	<code>(Instant AP) (managed-mode-profile) # download-method <ftp ftps></code> You can use either FTP or FTPS for downloading configuration files.
5. Specify the name of the server or the IP address of the server from which the configuration file must be downloaded.	<code>(Instant AP) (managed-mode-profile) # server <server_name></code>
6. Configure the day and time at which the OAW-IAPs can poll the configuration files from the server.	<code>(Instant AP) (managed-mode-profile) # sync-time day <dd> hour <hh> min <mm> window <window></code> Based on the expected frequency of configuration changes and maintenance window, you can set the configuration synchronization timeline. <ul style="list-style-type: none"> <code>day <dd></code>— Indicates day, for example to configure Sunday as the day, specify 01. To configure the synchronization period as everyday, specify 00. <code>hour <hh></code>—Indicates hour within the range of 0-23. <code>min <mm></code>—Indicates minutes within the range of 0-59. <code>window <hh></code>—Defines a window for synchronization of the configuration file. The default value is 3 hours.
7. Configure the time interval in minutes between two retries, after which OAW-IAPs can retry downloading the configuration file.	<code>(Instant AP) (managed-mode-profile) # retry-poll-period <seconds></code> NOTE: Specify the retry interval in seconds within the range of 5-60 seconds. The default retry interval is 5 seconds.
8. Apply the configuration changes.	<code>(Instant AP) (managed-mode-profile) # end</code> <code>(Instant AP) # commit apply</code>

If you want to apply the configuration immediately and do not want to wait until next configuration retrieval attempt, execute the following command:

```
(Instant AP) # managed-mode-sync-server
```

Example

```
(Instant AP) (config) # managed-mode-profile
(Instant AP) (managed-mode-profile) # username <username>
(Instant AP) (managed-mode-profile) # password <password>
(Instant AP) (managed-mode-profile) # config-filename instant.cfg
(Instant AP) (managed-mode-profile) # download-method ftps
(Instant AP) (managed-mode-profile) # sync-time day 00 hour 03 min 30 window 02
(Instant AP) (managed-mode-profile) # retry-poll-period 10
(Instant AP) (managed-mode-profile) # end
(Instant AP) # commit apply
```

Verifying the Configuration

To verify if the automatic configuration functions, perform the following checks:

1. Verify the status of configuration by running following commands at the command prompt:

```
(Instant AP) # show managed-mode config
(Instant AP) # show managed-mode status
```

2. Verify the status of download by running the following command at the command prompt:

```
(Instant AP) # show managed-mode logs
```

If the configuration settings retrieved in the configuration file are incomplete, OAW-IAPs reboot with the earlier configuration.

This chapter describes the following AOS-W Instant UI elements:

- [Login Screen](#)
- [Main Window](#)

Login Screen

The AOS-W Instant login page allows you to:

- View AOS-W Instant Network Connectivity summary
- View the AOS-W Instant UI in a specific language
- Log in to the AOS-W Instant UI

Viewing Connectivity Summary

The login page also displays the connectivity status to the AOS-W Instant network. The users can view a summary that indicates the status of the Internet availability, uplink, cellular modem and signal strength, VPN, and OmniVista configuration details before logging in to the AOS-W Instant UI.

The following figure shows the information displayed in the connectivity summary:

Figure 3 Connectivity Summary

Internet:	Reachable
Active uplink:	eth0
Cellular Provider:	No modem installed
Cellular Signal:	No modem installed
Primary VPN:	Down
Secondary VPN:	Down
AirWave:	Not configured

Language

The **Language** drop-down lists the languages and allows users to select their preferred language before logging in to the AOS-W Instant UI. A default language is selected based on the language preferences in the client desktop operating system or browser. If AOS-W Instant cannot detect the language, then **English** is used as the default language.

You can also select the required language option from the **Languages** drop-down located at the bottom left corner of the AOS-W Instant main window.

Logging into the AOS-W Instant UI

To log in to the AOS-W Instant UI, enter the following credentials:

- Username— admin
- Password— admin

The AOS-W Instant UI main window is displayed.

Main Window

On logging into Instant, the Instant UI Main Window is displayed. The following figure shows the AOS-W Instant main window:

Figure 4 AOS-W Instant Main Window

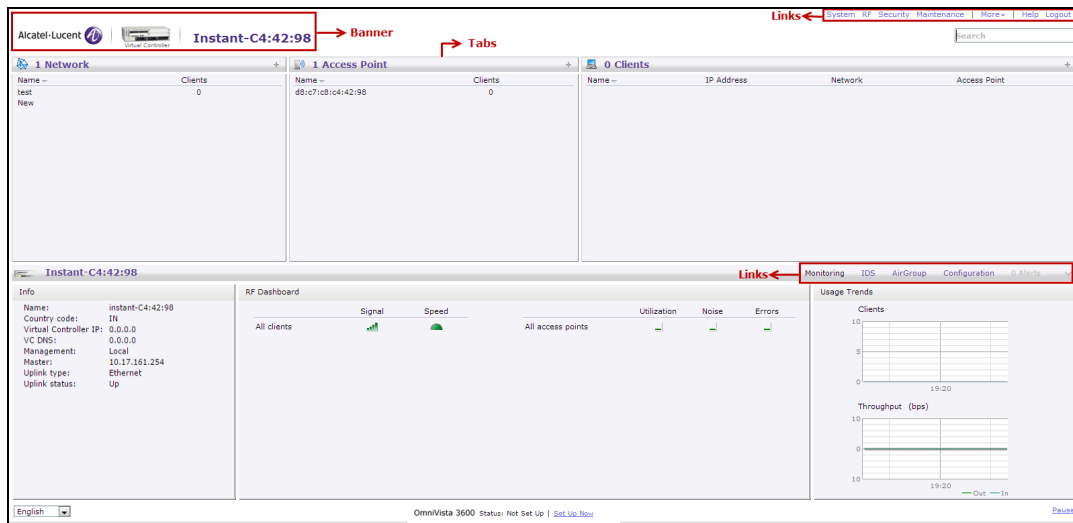

The main window consists of the following elements:

- [Banner](#)
- [Search](#)
- [Tabs](#)
- [Links](#)
- [Views](#)

Banner

The banner is a horizontal rectangle that appears at the top left corner of the AOS-W Instant main window. It displays the company name, logo, and Virtual Controller's name.

Search

Administrators can search for an OAW-IAP, client, or a network in the **Search** text box. When you type a search text, the search function suggests matching keywords and allows you to automatically complete the search text entry.

Tabs

The AOS-W Instant main window consists of the following tabs:

- [Networks Tab](#)— Provides information about the network profiles configured in the Instant network.
- [Access Points Tab](#)— Provides information about the OAW-IAPs configured in the Instant network.
- [Clients Tab](#)— Provides information about the clients in the Instant network.

Each tab appears in a compressed view by default. The number of networks, OAW-IAPs, or clients in the network precedes the tab names. The individual tabs can be expanded or collapsed by clicking on the tabs. The list items in each tab can be sorted by clicking the triangle icon next to the heading labels.

Networks Tab

This tab displays a list of Wi-Fi networks that are configured in the Instant network. The network names are displayed as links. The expanded view displays the following information about each WLAN SSID:

- **Name**—Name of the network.
- **Clients**—Number of clients that are connected to the network.
- **Type**—Type of network type such as Employee, Guest, or Voice.
- **Band**—Band in which the network is broadcast: 2.4 GHz band, 5 GHz band, or both.
- **Authentication Method**—Authentication method required to connect to the network.
- **Key Management**—Authentication key type.
- **IP Assignment**—Source of IP address for the client.
- **Zone**—AP zone configured on the SSID.

To add a wireless network profile, click the **New** link on the **Networks** tab. To edit, click the **edit** link that is displayed on clicking the network name in the **Networks** tab. To delete a network, click on the link **x**.

For more information on the procedure to add or modify a wireless network, see [Wireless Network Profiles on page 90](#).

Access Points Tab

If the Auto Join Mode feature is enabled, a list of enabled and active OAW-IAPs in the AOS-W Instant network is displayed on the **Access Points** tab. The OAW-IAP names are displayed as links. If the Auto Join Mode feature is disabled, the **New** link is displayed. Click this link to add a new OAW-IAP to the network. If an OAW-IAP is configured and not active, its MAC Address is displayed in red.

The expanded view of the **Access Points** tab displays the following information about each OAW-IAP:

- **Name**—Name of the OAW-IAP. If the OAW-IAP functions as a master OAW-IAP in the network, the asterisk sign "*" is displayed next to the OAW-IAP.
- **IP Address**—IP address of the OAW-IAP.
- **Mode**—Mode of the OAW-IAP.
 - **Access**—In this mode, the AP serves clients and scans the home channel for spectrum analysis while monitoring channels for rogue APs in the background.
 - **Monitor**—In this mode, the AP acts as a dedicated Air Monitor (AM), scanning all channels for rogue APs and clients.
- **Spectrum**—When enabled, the AP functions as a dedicated full-spectrum RF monitor, scanning all channels to detect interference from neighboring APs or non-Wi-Fi devices such as microwaves and cordless phones. When Spectrum is enabled, the AP does not provide access services to clients.
- **Clients**—Number of clients that are currently associated to the OAW-IAP.
- **Type**—Model number of the OAW-IAP.
- **Mesh Role**—Role of the OAW-IAP as a mesh portal or mesh point.
- **Zone**—AP zone.
- **Serial number**—Serial number of the device.
- **Channel**—Channel on which the OAW-IAP is currently broadcast.
- **Power (dB)**—Maximum transmission EIRP of the radio.
- **Utilization (%)**—Percentage of time that the channel is utilized.
- **Noise (dBm)**—Noise floor of the channel.

An **edit** link is displayed on clicking the OAW-IAP name. For details about editing OAW-IAP settings see [Customizing OAW-IAP Settings on page 81](#).

Clients Tab

This tab displays a list of clients that are connected to the AOS-W Instant network. The client names are displayed as links. The expanded view displays the following information about each client:

- **Name**—User name of the client or guest users if available.
- **IP Address**—IP address of the client.
- **MAC Address**—MAC address of the client.
- **OS**—Operating system that runs on the client.
- **ESSID**—The ESSID to which the client is connected.
- **Access Point**—to which the client is connected.
- **Channel**—The client operating channel.
- **Type**—Type of the Wi-Fi client.
- **Role**—Role assigned to the client.
- **Signal**—Current signal strength of the client, as detected by the AP.
- **Speed (mbps)**—Current speed at which data is transmitted. When the client is associated with an AP, it constantly negotiates the speed of data transfer. A value of 0 means that the AP has not heard from the client for some time.

Links

The following links allow you to configure various features for the AOS-W Instant network:

- [New Version Available](#)
- [System](#)
- [RF](#)
- [Security](#)
- [Maintenance](#)
- [More](#)
- [Help](#)
- [Logout](#)
- [Monitoring](#)
- [Client Match](#)
- [AppRF](#)
- [Spectrum](#)
- [Alerts](#)
- [IDS](#)
- [Configuration](#)
- [AirGroup](#)
- [OmniVista Setup](#)
- [Pause/Resume](#)

Each of these links is explained in the subsequent sections.

New Version Available

This link is displayed in the top right corner of the AOS-W Instant main window only if a new image version is available on the image server and OmniVista is not configured. For more information about the **New version available** link and its functions, see [Upgrading an OAW-IAP on page 353](#).

System

This link displays the **System** window. The **System** window consists of the following tabs:



Use the **Show/Hide Advanced** option at the bottom of the **System** window to view or hide the advanced options.

- **General**— Allows you to configure, view or edit the Name, IP address, NTP Server, and other OAW-IAP settings for the Virtual Controller.
- **Admin**—Allows you to configure administrator credentials for access to the Virtual Controller Management User Interface. You can also configure OmniVista in this tab. For more information on management interface and OmniVista configuration, see [Managing OAW-IAP Users on page 150](#) and [Managing an OAW-IAP from OmniVista on page 307](#) respectively.
- **Uplink**—Allows you to view or configure uplink settings. See [Uplink Configuration on page 318](#) for more information.
- **L3 Mobility**—Allows you to view or configure the Layer-3 mobility settings. See [Configuring L3-Mobility on page 343](#) for more information.
- **Enterprise Domains**—Allows you to view or configure the DNS domain names that are valid in the enterprise network. See [Configuring Enterprise Domains on page 201](#) for more information.
- **Monitoring**—Allows you to view or configure the following details:
 - **Syslog**—Allows you to view or configure Syslog Server details for sending syslog messages to the external servers. See [Configuring a Syslog Server on page 369](#) for more information.
 - **TFTP Dump**—Allows you to view or configure a TFTP dump server for core dump files. See [Configuring TFTP Dump Server on page 371](#) for more information.
 - **SNMP**—Allows you to view or configure SNMP agent settings. See [Configuring SNMP on page 365](#) for more information.
- **WISPr**—Allows you to view or configure the WISPr settings. See [Configuring WISPr Authentication on page 182](#) for more information.
- **Proxy**—Allows you to configure HTTP proxy on an OAW-IAP. See [Configuring HTTP Proxy on an OAW-IAP on page 353](#) for more information.
- **Time Based Services**—Allows you to configure a time profile which can be assigned to the SSID configured on the OAW-IAP. See [Configuring Time Based Services on page 225](#)

RF

The **RF** link displays a window for configuring Adaptive Radio Management (ARM) and Radio features.

- **ARM**—Allows you to view or configure channel and power settings for all the OAW-IAPs in the network. For information about ARM configuration, see [ARM Overview on page 257](#).
- **Radio**—Allows you to view or configure radio settings for 2.4 GHz and the 5 GHz radio profiles. For information about Radio, see [Configuring Radio Settings on page 264](#).

Security

The **Security** link displays a window with the following tabs:

- **Authentication Servers**— Use this tab to configure an external RADIUS server for a wireless network. For more information, see [Configuring an External Server for Authentication on page 163](#).
- **Users for Internal Server**— Use this tab to populate the system's internal authentication server with users. This list is used by networks for which per-user authorization is specified using the Virtual Controller's internal authentication server. For more information about users, see [Managing OAW-IAP Users on page 150](#).

- **Roles**— Use this tab to view the roles defined for all the Networks. The Access Rules part allows you to configure permissions for each role. For more information, see [Configuring User Roles on page 204](#) and [Configuring ACL Rules for Network Services on page 189](#).
- **Blacklisting**— Use this tab to blacklist clients. For more information, see [Blacklisting Clients on page 183](#).
- **Firewall Settings**— Use this tab to enable or disable Application Layer Gateway (ALG) supporting address and port translation for various protocols and to configure protection against wired attacks. For more information, see [Configuring ALG Protocols on page 194](#) and [Configuring Firewall Settings for Protection from ARP Attacks on page 195](#)
- **Inbound Firewall**— Use this tab to enhance the inbound firewall by allowing configuration of inbound firewall rules, management subnets, and restricted corporate access through an uplink switch. For more information, see [Managing Inbound Traffic on page 196](#).
- **Walled Garden**—Use this tab to allow or prevent access to a selected list of websites. For more information, see [Configuring Walled Garden Access on page 148](#).
- **External Captive Portal**— Use this tab to configure external captive portal profiles. For more information, see [Configuring External Captive Portal for a Guest Network on page 136](#).
- **Custom Blocked Page URL**—Use this tab to create a list of URLs that can be blocked using an ACL rule. For more information, see [Creating Custom Error Page for Web Access Blocked by AppRF Policies on page 203](#).

Maintenance

The **Maintenance** link displays a window that allows you to maintain the Wi-Fi network. The **Maintenance** window consists of the following tabs:

- **About**—Displays the name of the product, build time, OAW-IAP model name, the AOS-W Instant version, website address of Alcatel-Lucent, and Copyright information.
- **Configuration**— Displays the following details:
 - **Current Configuration**—Displays the current configuration details.
 - **Clear Configuration** —Allows you to clear the current configuration details of the network.
 - **Backup Configuration**—Allows you to back up local configuration details. The backed up configuration data is saved in the file named **instant.cfg**.
 - **Restore Configuration**—Allows you to restore the backed up configuration. The OAW-IAP must be rebooted after restoring the configuration for the changes to affect.
- **Certificates**—Displays information about the certificates installed on the OAW-IAP. You can also upload new certificates to the OAW-IAP database. For more information, see [Uploading Certificates on page 186](#).
- **Firmware**—Displays the current firmware version and provides various options to upgrade to a new firmware version. For more information, see [Upgrading an OAW-IAP on page 353](#).
- **Reboot**—Displays the OAW-IAPs in the network and provides an option to reboot the required access point or all access points. For more information, see [Upgrading an OAW-IAP on page 353](#).
- **Convert**—Provides an option to convert an OAW-IAP to a OmniAccess WLAN Switch managed Remote AP or Campus AP, or to the default Virtual Controller mode. For more information, see [Converting an OAW-IAP to a Remote AP and Campus AP on page 357](#).

More

The **More** link allows you to select the following options:

- [VPN](#)
- [IDS](#)
- [Wired](#)
- [Services](#)

- DHCP Server
- Support

VPN

The **VPN** window allows you to define communication settings with a remote Switch. See [VPN Configuration on page 232](#) for more information. The following figure shows an example of the IPSec configuration options available in the **VPN** window:

Figure 5 VPN window for IPSec Configuration



IDS

The IDS window allows you to configure wireless intrusion detection and protection levels. The following figures show the **IDS** window:

Figure 6 IDS Window: Intrusion Detection

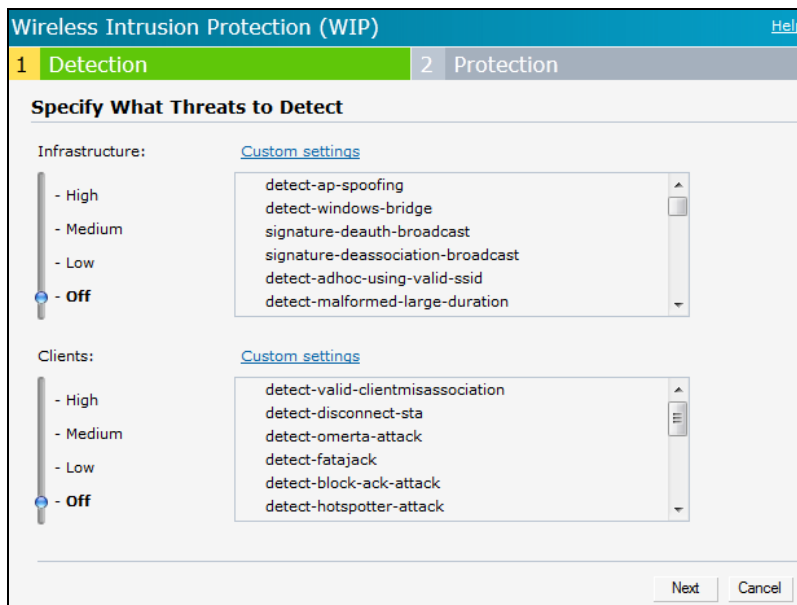

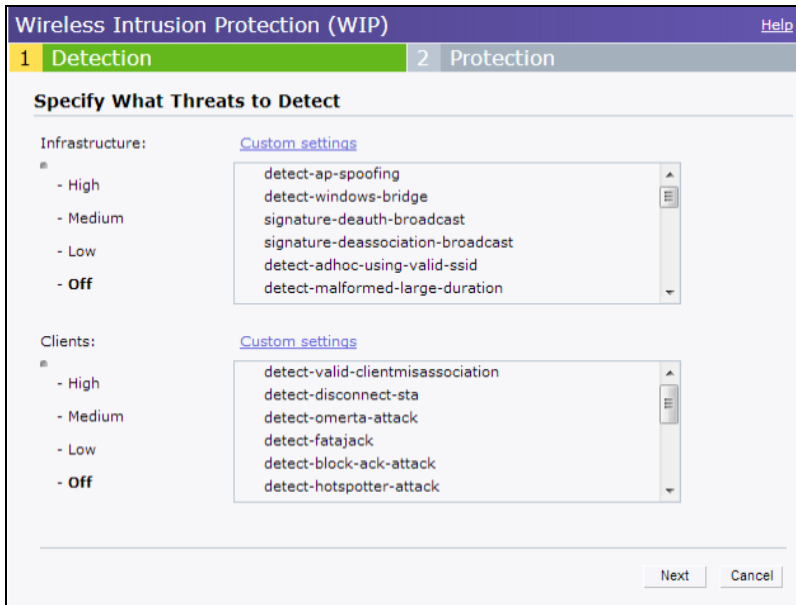

Figure 7 IDS Window: Intrusion Protection



For more information on wireless intrusion detection and protection, see [Detecting and Classifying Rogue APs on page 331](#).

Wired

The **Wired** window allows you to configure a wired network profile. See [Wired Profiles on page 115](#) for more information. The following figure shows the **Wired** window:

Figure 8 *Wired Window*

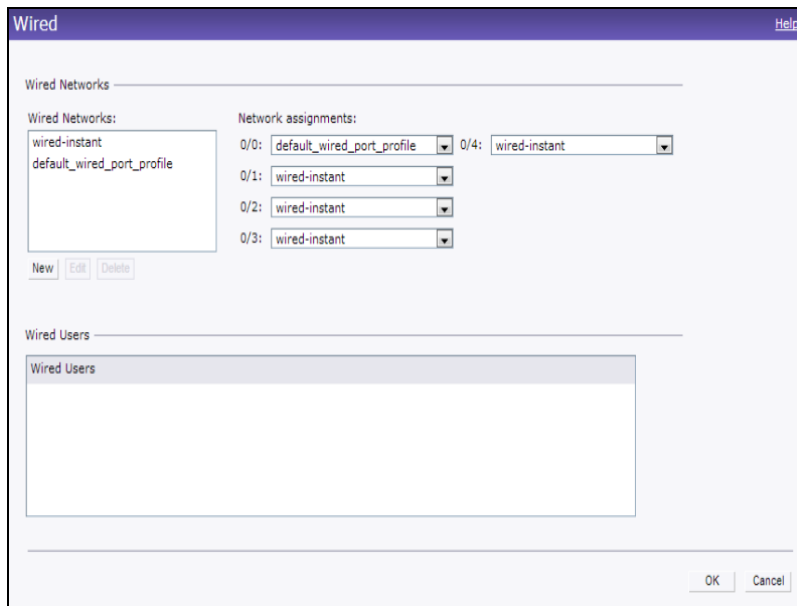

Services

The **Services** window allows you to configure services such as AirGroup, RTLS, and OpenDNS. The Services window consists of the following tabs:

- **AirGroup**—Allows you to configure the AirGroup and AirGroup services. For more information, see [AirGroup Configuration on page 284](#).
- **RTLS**—Allows you to integrate OmniVista Management platform or third-party Real Time Location Server such as Aeroscout Real Time Location Server with AOS-W Instant. For more information, see [Configuring an OAW-IAP for RTLS Support on page 292](#).

The RTLS tab also allows you to integrate OAW-IAP with the Analytics and Location Engine (ALE). For more information about configuring an OAW-IAP for ALE integration, see [Configuring an OAW-IAP for Analytics and Location Engine Support on page 294](#).

- **OpenDNS**— Allows you to configure support for OpenDNS business solutions, which require an OpenDNS (www.opendns.com) account. The OpenDNS credentials are used by AOS-W Instant and OmniVista to filter content at the enterprise level. For more information, see [Configuring OpenDNS Credentials on page 296](#).
- **CALEA**—Allows you configure support for Communications Assistance for Law Enforcement Act (CALEA) server integration, thereby ensuring compliance with Lawful Intercept and CALEA specifications. For more information, see [CALEA Integration and Lawful Intercept Compliance on page 301](#).
- **Network Integration**—Allows you to configure an OAW-IAP for integration with Palo Alto Networks (PAN) Firewall and XML API server. For more information about OAW-IAP integration with PAN, see [Integrating an OAW-IAP with Palo Alto Networks Firewall on page 297](#) and [Integrating an OAW-IAP with an XML API interface on page 298](#).

The following figure shows the default view of the **Services** window:

Figure 9 *Services Window: Default View*

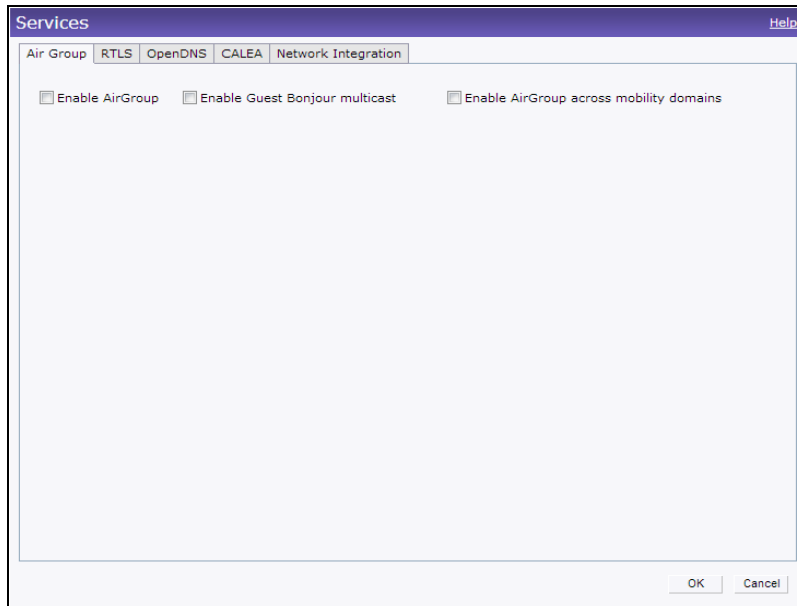

DHCP Server

The DHCP Servers window allows you to configure various DHCP modes. The following figure shows the contents of the **DHCP Servers** window:

Figure 10 *DHCP Servers Window*

For more information, see [DHCP Configuration on page 215](#).

Support

The **Support** consists of the following fields:

- **Command**— Allows you to select a support command for execution.
- **Target**—Displays a list of OAW-IAPs in the network.
- **Run**— Allows you to execute the selected command for a specific OAW-IAP or all OAW-IAPs and view logs.
- **Auto Run**— Allows you to configure a schedule for automatic execution of a support command for a specific OAW-IAP or all OAW-IAPs.
- **Filter**—Allows you to filter the contents of a command output.
- **Clear**—Clears the command output displayed after a command is executed.
- **Save**— Allows you to save the support command logs as an HTML or text file.

For more information on support commands, see [Running Debug Commands from the UI on page 372](#).

Help

The **Help** link allows you to view a short description or definition of selected terms and fields in the UI windows or dialogs.

To activate the context-sensitive help:

1. Click the **Help** link at the top right corner of AOS-W Instant main window.
2. Click any text or term displayed in green italics to view its description or definition.
3. To disable the help mode, click **Done**.

Logout

The **Logout** link allows you to log out of the AOS-W Instant UI.

Monitoring

The **Monitoring** link displays the Monitoring pane for the AOS-W Instant network. Use the down arrow  located to the right side of these links to compress or expand the monitoring pane.

The monitoring pane consists of the following sections:

- [Info](#)
- [RF Dashboard](#)
- [RF Trends](#)
- [Usage Trends](#)
- [Mobility Trail](#)

Info

The **Info** section displays the configuration information of the Virtual Controller by default. On selecting the Network View tab, the monitoring pane displays configuration information of the selected network. Similarly in the Access Point or the Client view, this section displays the configuration information of the selected OAW-IAP or the client.

Table 9: Contents of the Info Section in the AOS-W Instant Main Window

Name	Description
<p>Info section in Virtual Controller view</p>	<p>The Info section in the Virtual Controller view displays the following information:</p> <ul style="list-style-type: none"> ● Name— Displays the Virtual Controller name. ● Country Code— Displays the Country in which the Virtual Controller is operating. ● Virtual Controller IP address— Displays the IP address of the Virtual Controller. ● VC DNS—Displays the DNS IP address configured for Virtual Controller. ● Management: Indicates if the OAW-IAP is managed locally or through OmniVista. ● Master— Displays the IP address of the Access Point acting as Virtual Controller. ● OpenDNS Status— Displays the OpenDNS status. If the OpenDNS status indicates Not Connected, ensure that the network connection is up and appropriate credentials are configured for OpenDNS. ● MAS integration— Displays the status of the MAS integration feature. ● Uplink type—Displays the type of uplink configured on the OAW-IAP, for example, Ethernet or 3G. ● Uplink status—Indicates the uplink status. ● Blacklisted clients—Displays the number of blacklisted clients. ● Internal RADIUS Users—Displays the number of internal RADIUS users. ● Internal Guest Users—Displays the number of internal guest users. ● Internal User Open Slots— Displays the available slots for user configuration as supported by the OAW-IAP model.
<p>Info section in Network view</p>	<p>The Info section in the Network view displays the following information:</p> <ul style="list-style-type: none"> ● Name—Displays the name of the network. ● Status—Displays the status of the network. ● Type—Displays the type of network, for example, Employee, Guest, or Voice. ● VLAN—Displays VLAN details. ● IP Assignment— Indicates if the OAW-IAP clients are assigned IP address from the network that the Virtual Controller is connected to, or from an internal auto-generated IP scope from the Virtual Controller. ● Access— Indicates the level of access control configured for the network. ● WMM DSCP—Displays WMM DSCP mapping details. ● Security level— Indicates the type of user authentication and data encryption configured for the network. <p>The info section for WLAN SSIDs also indicates status of captive portal and CALEA ACLs and provides a link to upload certificates for internal server. For more information, see Uploading Certificates on page 186.</p>
<p>Info section in Access Point view</p>	<p>The Info section in the Access Point view displays the following information:</p>

Table 9: Contents of the Info Section in the AOS-W Instant Main Window

Name	Description
	<ul style="list-style-type: none"> ● Name—Displays the name of the selected OAW-IAP. ● IP Address—Displays the IP address of the OAW-IAP. ● Mode—Displays the mode in which the AP is configured to operate. ● Spectrum—Displays the status of the spectrum monitor. ● Clients—Number of clients associated with the OAW-IAP. ● Type—Displays the model number of the OAW-IAP. ● Zone—Displays AP zone details. ● CPU Utilization—Displays the CPU utilization in percentage. ● Memory Free—Displays the memory availability of the OAW-IAP in MB. ● Serial number—Displays the serial number of the OAW-IAP. ● MAC— Displays the MAC address. ● From Port— Displays the port from where the slave OAW-IAP is learned in hierarchy mode.
<p>Info section in Client view</p>	<p>The Info section in the Client view displays the following information:</p> <ul style="list-style-type: none"> ● Name— Displays the name of the client. ● IP Address— Displays IP address of the client. ● MAC Address— Displays MAC Address of the client. ● OS— Displays the Operating System that is running on the client. ● ESSID— Indicates the network to which the client is connected. ● Access Point— Indicates the OAW-IAP to which the client is connected. ● Channel— Indicates the channel that is currently used by the client. ● Type— Displays the channel type on which client is broadcasting. ● Role—Displays the role assigned to the client.

RF Dashboard

The **RF Dashboard** section lists the OAW-IAPs that exceed the utilization, noise, or error threshold. It also shows the clients with low speed or signal strength in the network and the RF information for the OAW-IAP to which the client is connected.

The OAW-IAP names are displayed as links. When an OAW-IAP is clicked, the OAW-IAP configuration information is displayed in the Info section and the RF Dashboard section is displayed at the bottom left corner of the AOS-W Instant main window.

The following figure shows an example of the RF dashboard with Utilization, Band frames, Noise Floor, and Errors details:

Figure 11 RF Dashboard in the Monitoring Pane

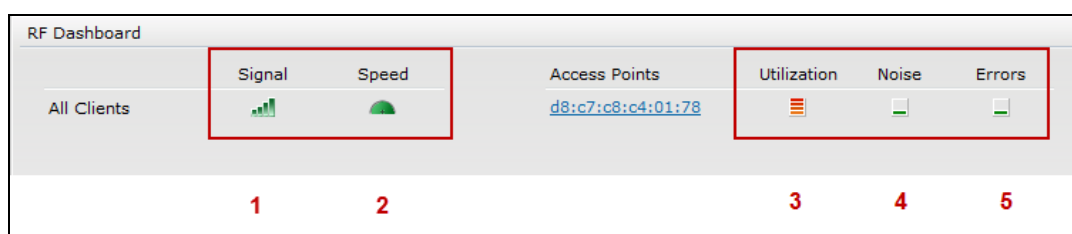

The following table describes the icons available on the RF Dashboard pane:

Table 10: *RF Dashboard Icons*

Icon	Name	Description
1	Signal Icon	<p>Displays the signal strength of the client. Depending on the signal strength of the client, the color of the lines on the Signal bar changes from Green > Orange > Red.</p> <ul style="list-style-type: none"> • Green— Signal strength is more than 20 decibels. • Orange— Signal strength is between 15-20 decibels. • Red— Signal strength is less than 15 decibels. <p>To view the signal graph for a client, click on the signal icon next to the client in the Signal column.</p>
2	Speed icon	<p>Displays the data transfer speed of the client. Depending on the data transfer speed of the client, the color of the Signal bar changes from Green > Orange > Red.</p> <ul style="list-style-type: none"> • Green— Data transfer speed is more than 50 percent of the maximum speed supported by the client. • Orange— Data transfer speed is between 25-50 percent of the maximum speed supported by the client. • Red— Data transfer speed is less than 25 percent of the maximum speed supported by the client. <p>To view the data transfer speed graph of a client, click on the speed icon against the client in the Speed column.</p>
3	Utilization icon	<p>Displays the radio utilization rate of the OAW-IAPs. Depending on the percentage of utilization, the color of the lines on the Utilization icon changes from Green > Orange > Red.</p> <ul style="list-style-type: none"> • Green— Utilization is less than 50 percent. • Orange— Utilization is between 50-75 percent. • Red— Utilization is more than 75 percent. <p>To view the utilization graph of an OAW-IAP, click the Utilization icon next to the OAW-IAP in the Utilization column.</p>

Table 10: RF Dashboard Icons

Icon	Name	Description
4	Noise icon	<p>Displays the noise floor details for the OAW-IAPs. Noise is measured in decibels/meter. Depending on the noise floor, the color of the lines on the Noise icon changes from Green > Orange > Red.</p> <ul style="list-style-type: none"> Green— Noise floor is more than 87 dBm. Orange— Noise floor is between 80 dBm-87 dBm. Red— Noise floor is less than 80 dBm. <p>To view the noise floor graph of an OAW-IAP, click the noise icon next to the OAW-IAP in the Noise column.</p>
5	Errors icon	<p>Displays the errors for the OAW-IAPs. Depending on the errors, color of the lines on the Errors icon changes from Green > Yellow > Red.</p> <ul style="list-style-type: none"> Green— Errors are less than 5000 frames per second. Orange— Errors are between 5000-10000 frames per second. Red— Errors are more than 10000 frames per second. <p>To view the errors graph of an OAW-IAP, click the Errors icon next to the OAW-IAP in the Errors column.</p>

RF Trends

The **RF Trends** section displays the following graphs for the selected AP and the client. To view the details on the graphs, click the graphs and hover the mouse on a data point:

Figure 12 RF Trends for Access Point

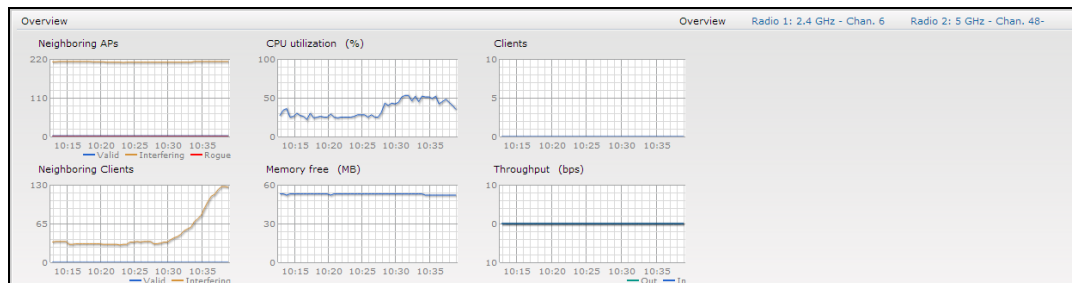
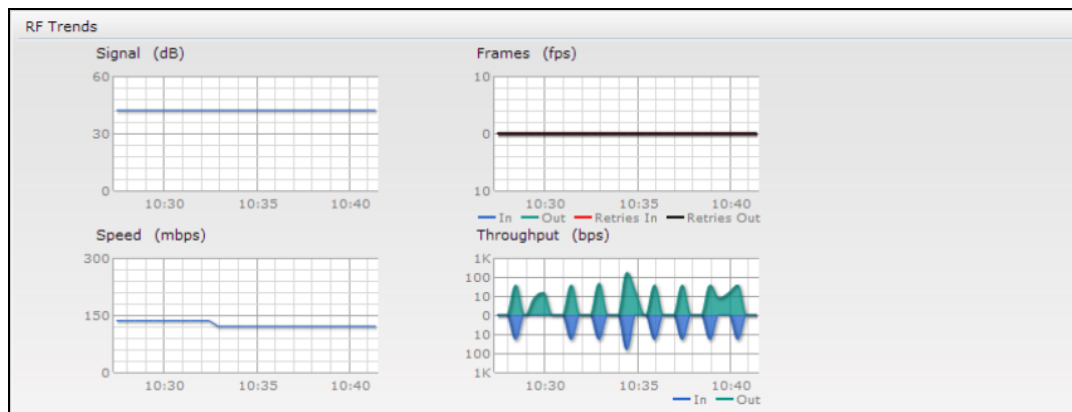

Figure 13 RF Trends for Clients



Usage Trends

The **Usage Trends** displays the following graphs:

- Clients—In the default view, the Clients graph displays the number of clients that were associated with the Virtual Controller in the last 15 minutes. In Network or Access Points view, this graph displays the number of clients that were associated with the selected network or OAW-IAP in the last 15 minutes.
- Throughput— In the default view, the Throughput graph displays the incoming and outgoing throughput traffic for the Virtual Controller in the last 15 minutes. In the Network or Access Points view, this graph displays the incoming and outgoing throughput traffic for the selected network or OAW-IAP in the last 15 minutes.

Figure 14 Usage Trends Graphs in the Default View

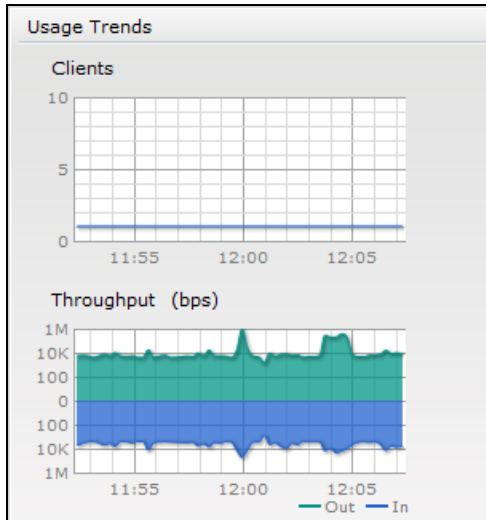

The following table describes the graphs displayed in the Network view:

Table 11: Network View—Graphs and Monitoring Procedures

Graph Name	Description	Monitoring Procedure
Clients	<p>The Clients graph shows the number of clients associated with the network for the last 15 minutes.</p> <p>To see an enlarged view, click the graph.</p> <ul style="list-style-type: none"> The enlarged view provides Last, Minimum, Maximum, and Average statistics for the number of clients associated with the Virtual Controller for the last 15 minutes. To see the exact number of clients in the AOS-W Instant network at a particular time, move the cursor over the graph line. 	<p>To check the number of clients associated with the network for the last 15 minutes,</p> <ol style="list-style-type: none"> Log in to the AOS-W Instant UI. The Virtual Controller view appears. This is the default view. On the Networks tab, click the network for which you want to check the client association. The Network view is displayed. Study the Clients graph in the Usage Trends pane. For example, the graph shows that one client is associated with the selected network at 12:00 hours.
Throughput	<p>The Throughput graph shows the throughput of the selected network for the last 15 minutes.</p> <ul style="list-style-type: none"> Outgoing traffic—Throughput for outgoing traffic is displayed in green. Outgoing traffic is shown above the median line. Incoming traffic—Throughput for incoming traffic is displayed in blue. Incoming traffic is shown below the median line. <p>To see an enlarged view, click the graph.</p> <ul style="list-style-type: none"> The enlarged view provides Last, Minimum, Maximum, and Average statistics for the incoming and outgoing traffic throughput of the network for the last 15 minutes. <p>To see the exact throughput of the selected network at a particular time, move the cursor over the graph line.</p>	<p>To check the throughput of the selected network for the last 15 minutes,</p> <ol style="list-style-type: none"> Log in to the AOS-W Instant UI. The Virtual Controller view is displayed. This is the default view. On the Networks tab, click the network for which you want to check the client association. The Network view is displayed. Study the Throughput graph in the Usage Trends pane. For example, the graph shows 22.0 Kbps incoming traffic throughput for the selected network at 12:03 hours.

The following table describes the graphs displayed in the Access Point view:

Table 12: Access Point View—Usage Trends and Monitoring Procedures

Graph Name	Description	Monitoring Procedure
Neighboring APs	<p>The Neighboring APs graph shows the number of APs heard by the selected OAW-IAP:</p> <ul style="list-style-type: none"> Valid APs: An AP that is part of the enterprise providing WLAN service. Interfering APs: An AP that is seen in the RF environment but is not connected to the network. Rogue APs: An unauthorized AP that is plugged into the wired side of the network. <p>To see the number of different types of neighboring APs for the last 15 minutes, move the cursor over the respective graph lines.</p>	<p>To check the neighboring APs detected by the OAW-IAP for the last 15 minutes,</p> <ol style="list-style-type: none"> Log in to the AOS-W Instant UI. The Virtual Controller view is displayed. This is the default view. On the Access Points tab, click the OAW-IAP for which you want to monitor the client association. The OAW-IAP view is displayed. Study the Neighboring APs graph in the Overview section. For example, the graph shows that 148 interfering APs are detected by the OAW-IAP at 12:04 hours.
CPU Utilization	<p>The CPU Utilization graph displays the utilization of CPU for the selected OAW-IAP.</p> <p>To see the CPU utilization of the OAW-IAP, move the cursor over the graph line.</p>	<p>To check the CPU utilization of the OAW-IAP for the last 15 minutes,</p> <ol style="list-style-type: none"> Log in to the AOS-W Instant UI. The Virtual Controller view is displayed. This is the default view. On the Access Points tab, click the OAW-IAP for which you want to monitor the client association. The OAW-IAP view is displayed. Study the CPU Utilization graph in the Overview pane. For example, the graph shows that the CPU utilization of the OAW-IAP is 30% at 12:09 hours.
Neighboring Clients	<p>The Neighboring Clients graph shows the number of clients not connected to the selected AP, but heard by it.</p> <ul style="list-style-type: none"> Any client that successfully authenticates with a valid AP and passes encrypted traffic is classified as a valid client. Interfering: A client associated to any AP and is not valid is classified as an interfering client. <p>To see the number of different types of neighboring clients for the last 15 minutes, move the cursor over the respective graph lines.</p>	<p>To check the neighboring clients detected by the OAW-IAP for the last 15 minutes,</p> <ol style="list-style-type: none"> Log in to the AOS-W Instant UI. The Virtual Controller view is displayed. This is the default view. On the Access Points tab, click the OAW-IAP for which you want to monitor the client association. The OAW-IAP view is displayed. Study the Neighboring Clients graph in the Overview pane. For example, the graph shows that 20 interfering clients were detected by the OAW-IAP at 12:15 hours.
Memory free (MB)	<p>The memory free graph displays the memory availability of the OAW-IAP in MB.</p>	<p>To check the free memory of the OAW-IAP for the last 15 minutes,</p>

Table 12: Access Point View—Usage Trends and Monitoring Procedures

Graph Name	Description	Monitoring Procedure
	<p>To see the free memory of the OAW-IAP, move the cursor over the graph line.</p>	<ol style="list-style-type: none"> 1. Log in to the AOS-W Instant UI. The Virtual Controller view is displayed. This is the default view. 2. On the Access Points tab, click the OAW-IAP for which you want to monitor the client association. The OAW-IAP view is displayed. 3. Study the Memory free graph in the Overview pane. For example, the graph shows that the free memory of the OAW-IAP is 64 MB at 12:13 hours.
<p>Clients</p>	<p>The Clients graph shows the number of clients associated with the selected OAW-IAP for the last 15 minutes.</p> <p>To see an enlarged view, click the graph. The enlarged view provides Last, Minimum, Maximum, and Average statistics for the number of clients associated with the OAW-IAP for the last 15 minutes.</p> <p>To see the exact number of clients associated with the selected OAW-IAP at a particular time, move the cursor over the graph line.</p>	<p>To check the number of clients associated with the OAW-IAP for the last 15 minutes,</p> <ol style="list-style-type: none"> 1. Log in to the AOS-W Instant UI. The Virtual Controller view is displayed. This is the default view. 2. On the Access Points tab, click the OAW-IAP for which you want to monitor the client association. The OAW-IAP view is displayed. 3. Study the Clients graph. For example, the graph shows that six clients are associated with the OAW-IAP at 12:11 hours.
<p>Throughput</p>	<p>The Throughput graph shows the throughput for the selected OAW-IAP for the last 15 minutes.</p> <ul style="list-style-type: none"> ● Outgoing traffic—Throughput for outgoing traffic is displayed in green. Outgoing traffic is shown about the median line. ● Incoming traffic—Throughput for incoming traffic is displayed in blue. Incoming traffic is shown below the median line. <p>To see an enlarged view, click the graph.</p> <ul style="list-style-type: none"> ● The enlarged view provides Last, Minimum, Maximum, and Average statistics for the incoming and outgoing traffic throughput of the OAW-IAP for the last 15 minutes. <p>To see the exact throughput of the selected OAW-IAP at a particular time, move the cursor over the graph line.</p>	<p>To check the throughput of the selected OAW-IAP for the last 15 minutes,</p> <ol style="list-style-type: none"> 1. Log in to the AOS-W Instant UI. The Virtual Controller view is displayed. This is the default view. 2. On the Access Points tab, click the OAW-IAP for which you want to monitor the throughput. The OAW-IAP view is displayed. 3. Study the Throughput graph. For example, the graph shows 44.03 Kbps incoming traffic throughput at 12:08 hours.

The following table describes the RF trends graphs available in the client view:

Table 13: Client View—RF Trends Graphs and Monitoring Procedures

Graph Name	Description	Monitoring Procedure
Signal	<p>The Signal graph shows the signal strength of the client for the last 15 minutes. It is measured in decibels.</p> <p>To see an enlarged view, click the graph. The enlarged view provides Last, Minimum, Maximum, and Average signal statistics of the client for the last 15 minutes.</p> <p>To see the exact signal strength at a particular time, move the cursor over the graph line.</p>	<p>To monitor the signal strength of the selected client for the last 15 minutes,</p> <ol style="list-style-type: none"> 1. Log in to the AOS-W Instant UI. The Virtual Controller view is displayed. This is the default view. 2. On the Clients tab, click the IP address of the client for which you want to monitor the signal strength. The client view is displayed. 3. Study the Signal graph in the RF Trends pane. For example, the graph shows that signal strength for the client is 54.0 dB at 12:23 hours.
Frames	<p>The Frames Graph shows the In and Out frame rate per second of the client for the last 15 minutes. It also shows data for the Retry In and Retry Out frames.</p> <ul style="list-style-type: none"> • Outgoing frames—Outgoing frame traffic is displayed in green. It is shown above the median line. • Incoming frames—Incoming frame traffic is displayed in blue. It is shown below the median line. • Retry Out—Retries for the outgoing frames are displayed above the median line in black . • Retry In—Retries for the incoming frames are displayed below the median line in red. <p>To see an enlarged view, click the graph. The enlarged view provides Last, Minimum, Maximum, and Average statistics for the In, Out, Retries In, and Retries Out frames.</p> <p>To see the exact frames at a particular time move the cursor over the graph line.</p>	<p>To monitor the In and Out frame rate per second and retry frames for the In and Out traffic, for the last 15 minutes,</p> <ol style="list-style-type: none"> 1. Log in to the AOS-W Instant UI. The Virtual Controller view is displayed. This is the default view. 2. On the Clients tab, click the IP address of the client for which you want to monitor the frames. The client view is displayed. 3. Study the Frames graph in the RF Trends pane. For example, the graph shows 4.0 frames per second for the client at 12:27 hours.
Speed	<p>The Speed graph shows the data transfer speed for the client. Data transfer is measured in Mbps.</p> <p>To see an enlarged view, click the graph. The enlarged view shows Last, Minimum, Maximum, and Average statistics of the client for the last 15 minutes.</p>	<p>To monitor the speed for the client for the last 15 minutes,</p> <ol style="list-style-type: none"> 1. Log in to the AOS-W Instant UI. The Virtual Controller view is displayed. This is the default view. 2. On the Clients tab, click the IP address of the client for which you want to monitor the speed. The client view is displayed.

Table 13: Client View—RF Trends Graphs and Monitoring Procedures

Graph Name	Description	Monitoring Procedure
	To see the exact speed at a particular time, move the cursor over the graph line.	3. Study the Speed graph in the RF Trends pane. For example, the graph shows that the data transfer speed at 12:26 hours is 240 Mbps.
Throughput	<p>The Throughput Graph shows the throughput of the selected client for the last 15 minutes.</p> <ul style="list-style-type: none"> • Outgoing traffic—Throughput for outgoing traffic is displayed in green. Outgoing traffic is shown above the median line. • Incoming traffic—Throughput for incoming traffic is displayed in blue. Incoming traffic is shown below the median line. <p>To see an enlarged view, click the graph. The enlarged view shows Last, Minimum, Maximum, and Average statistics for the incoming and outgoing traffic throughput of the client for the last 15 minutes.</p> <p>To see the exact throughput at a particular time, move the cursor over the graph line.</p>	<p>To monitor the errors for the client for the last 15 minutes,</p> <ol style="list-style-type: none"> 1. Log in to the AOS-W Instant UI. The Virtual Controller view is displayed. This is the default view. 2. In the Clients tab, click the IP address of the client for which you want to monitor the throughput. The client view is displayed. 3. Study the Throughput graph in the RF Trends pane. For example, the graph shows 1.0 Kbps outgoing traffic throughput for the client at 12:30 hours.

Mobility Trail

The **Mobility Trail** section displays the following mobility trail information for the selected client:

- **Association Time**— The time at which the selected client was associated with a particular OAW-IAP. The AOS-W Instant UI shows the client and OAW-IAP association over the last 15 minutes.
- **Access Point**— The OAW-IAP name with which the client was associated.



Mobility information about the client is reset each time it roams from one OAW-IAP to another.

Client Match

If client match is enabled, the **Client Match** link provides a graphical representation of radio map view of an AP and the client distribution on an AP radio.

On clicking an access point in the **Access Points** tab and the **Client Match** link, a stations map view is displayed and a graph is drawn with real-time data points for the AP radio. If the AP supports dual band, you can toggle between 2.4GHz and 5 GHz links in the client match graph area to view the data. When you hover the mouse on the graph, details such as RSSI, client match status, and the client distribution on channels are displayed.

The following figure shows the client distribution details for an AP radio.

Figure 15 Client Distribution on AP Radio

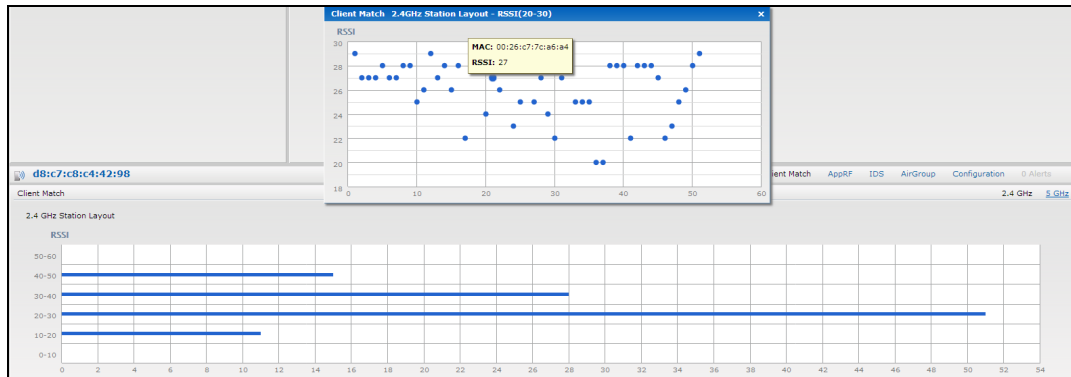

On clicking a client in the **Clients** tab and the **Client Match** link, a graph is drawn with real-time data points for an AP radio map. When you hover the mouse on the graph, details such as RSSI, channel utilization details, and client count on each channel are displayed.

The following figure shows the client view heat map for an AP radio:

Figure 16 Channel Availability Map for Clients

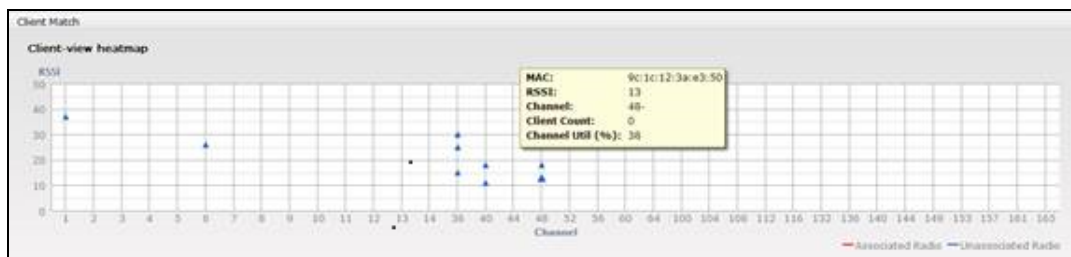

AppRF

The **AppRF** link displays the application traffic summary for OAW-IAPs and client devices. The **AppRF** link in the activity panel is displayed only if **AppRF visibility** is enabled in the **System** window. For more information on application visibility and AppRF charts, see [Application Visibility on page 269](#).

Spectrum

The spectrum link (in **Access Point** view) displays the spectrum data that is collected by a hybrid AP or by an OAW-IAP that has enabled spectrum monitor. The spectrum data is not reported to the Virtual Controller.

The spectrum link displays the following:

- **Device list** - The device list display consists of a device summary table and channel information for active non Wi-Fi devices currently seen by a spectrum monitor or hybrid AP radio.
- **Channel Utilization and Monitoring** - This chart provides an overview of channel quality across the spectrum. It shows channel utilization information such as channel quality, availability, and utilization metrics as seen by a spectrum monitor for the 2.4 GHz and 5 GHz radio bands. The first bar for each channel represents the percentage of air time used by non Wi-Fi interference and Wi-Fi devices. The second bar indicates the channel quality. A higher percentage value indicates better quality.
- **Channel Details** - When you move your mouse over a channel, the channel details or the summary of the 5 GHz and 2.4 GHz channels as detected by a spectrum monitor are displayed. You can view the aggregate data for each channel seen by the spectrum monitor radio, including the maximum AP power, interference and the Signal-to-Noise and Interference Ratio (SNIR). Spectrum monitors display spectrum analysis data

seen on all channels in the selected band, and hybrid OAW-IAPs display data from the one channel they are monitoring.

For more information on spectrum monitoring, see [Spectrum Monitor on page 345](#).

Alerts

Alerts are generated when a user encounters problems while accessing or connecting to a network. The alerts that are generated can be categorized as follows:

- 802.11 related association and authentication failure alerts
- 802.1X related mode and key mismatch, server, and client time-out failure alerts
- IP address related failures - Static IP address or DHCP related alerts.

The following figure shows the contents of details displayed on clicking the **Alerts** link:

Figure 17 Alerts Link

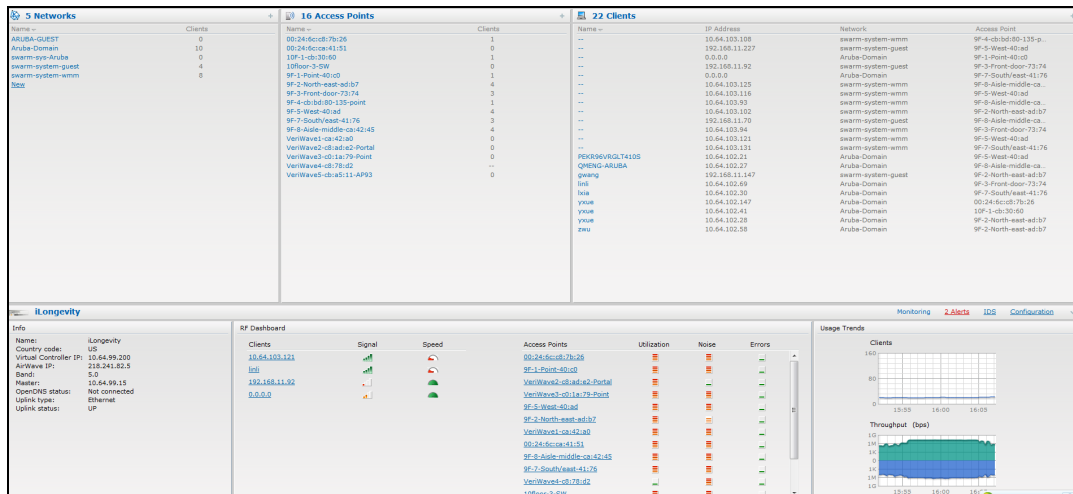

The **Alerts** link displays the following types of alerts:

- Client Alerts
- Active Faults
- Fault History

Table 14: Types of Alerts

Type of Alert	Description	Information Displayed
Client Alerts	The Client alerts occur when clients are connected to the AOS-W Instant network.	<p>A client alert displays the following fields:</p> <ul style="list-style-type: none"> • Timestamp— Displays the time at which the client alert was recorded. • MAC address— Displays the MAC address of the client that caused the alert. • Description— Provides a short description of the alert. • Access Points— Displays the IP address of the OAW-IAP to which the client is connected. • Details— Provides complete details of the alert.
Active Faults	The Active Faults occur in the event of a system fault.	<p>An Active Faults consists of the following fields:</p> <ul style="list-style-type: none"> • Time— Displays the system time when an event occurs. • Number— Indicates the number of sequence. • Description— Displays the event details.
Fault History	The Fault History alerts occur in the event of a system fault.	<p>The Fault History displays the following information:</p> <ul style="list-style-type: none"> • Time— Displays the system time when an event occurs. • Number— Indicates the number of sequence. • Cleared by— Displays the module which cleared this fault. • Description— Displays the event details.

The following figures show the client alerts, fault history, and active faults:

Figure 18 Client Alerts

The screenshot displays the AOS-W Instant User Interface with three main panels: 5 Networks, 16 Access Points, and 20 Clients. Below these panels is a 'Client Alerts' section showing a single alert.

Name	Clients	Name	Clients	Name	IP Address
ARUBA-GUEST	0	00-24-6c:cd:7b:26	2	--	192.168.11.70
Aruba Domain	8	00:24:6c:08:41:151	0	--	192.168.11.227
swarm-sys-Aruba	0	10f-3-cb:30:50	0	--	10.64.103.116
swarm-system-guest	3	10floor-3-SW	0	--	10.64.103.102
swarm-system-worm	0	9F-1-Front-40:ad	0	--	10.64.103.112
Isis		9F-2-North-east-ad:b7	5	--	10.64.103.94
		9F-3-Front-door-73:74	3	--	10.64.103.106
		9F-4-cb:bd:60-135-point	1	--	0.0.0.0
		9F-5-West-40:ad	3	--	10.64.103.93
		9F-7-South/coast-41:76	1	--	169.254.59.45
		9F-8-Juba-middle-ca:42:45	5	--	10.64.103.121
		VeriWave1-ca:42:a0	0	--	10.64.103.125
		VeriWave3-cb:ad:e2-Portal	0	PEKR56VRGLT4105	10.64.32.102
		VeriWave3-cb:1a:79-Point	0	QING-ARUBA	10.64.102.27
		VeriWave4-cb:78:d2	--	Isis	10.64.102.30
		VeriWave5-cb:a5:11-AP93	0	xxxx	192.168.11.147
				yxus	10.64.102.142
				yxus	10.64.102.41
				yxus	10.64.102.28
				zhu	10.64.102.58

Timestamp	MAC Address	Description	Access Point	Details
15:48:27	40:8f:bed:fc3:ca	DHCP request timed out	9F-8-West-40:ad	more

Figure 19 *Fault History*

Time	Number	Cleared By	Description
15:47:49	5	System	Access point 00:24:6c:ce:7b:26 is down
14:36:34	4	System	Access point 00:24:6c:ce:42:45 is down
08:27:19	3	System	Access point 00:24:6c:ce:d1:79 is down
08:26:33	2	System	Access point 00:24:6c:ce:1e:79 is down

Figure 20 *Active Faults*

Time	Number	Description
08:22:03	1	Access point 00:24:6c:ce:42:45 is down

The following table displays a list of alerts that are generated in the OAW-IAP network:

Table 15: *Alerts list*

Type and Description Code	Description	Details	Corrective Actions
100101	Internal error	The AP has encountered an internal error for this client.	Contact the Alcatel-Lucent customer support team.
100102	Unknown SSID in association request	The AP cannot allow this client to associate because the association request received contains an unknown SSID."	Identify the client and check its Wi-Fi driver and manager software.
100103	Mismatched authentication/encryption setting	The AP cannot allow this client to associate because its authentication or encryption settings do not match AP's configuration.	Ascertain the correct authentication or encryption settings and try to associate again.

Table 15: Alerts list

Type and Description Code	Description	Details	Corrective Actions
100104	Unsupported 802.11 rate	The AP cannot allow this client to associate because it does not support the 802.11 rate requested by this client.	Check the configuration on the OAW-IAP to see if the desired rate can be supported; if not, consider replacing the OAW-IAP with another model that can support the rate.
100105	Maximum capacity reached on AP	The AP has reached maximum capacity and cannot accommodate any more clients	Consider expanding capacity by installing additional OAW-IAPs or balance load by relocating OAW-IAPs.
100206	Invalid MAC Address	The AP cannot authenticate this client because its MAC address is not valid.	This condition may be indicative of a misbehaving client. Try to locate the client device and check its hardware and software.
100307	Client blocked due to repeated authentication failures	The AP is temporarily blocking the 802.1x authentication request from this client because the credentials provided have been rejected by the RADIUS server too many times.	Identify the client and check its 802.1X credentials.
100308	RADIUS server connection failure	The AP cannot authenticate this client using 802.1x because the RADIUS server did not respond to the authentication request. If the AP is using the internal RADIUS server, recommend checking the related configuration as well as the installed certificate and passphrase.	If the OAW-IAP is using the internal RADIUS server, Alcatel-Lucent recommends checking the related configuration as well as the installed certificate and passphrase. If the OAW-IAP is using an external RADIUS server, check if there are any issues with the RADIUS server and try connecting again.
100309	RADIUS server authentication failure	The AP cannot authenticate this client using 802.1X, because the RADIUS server rejected the authentication credentials (password, etc) provided by the client.	Ascertain the correct authentication credentials and log in again.

Table 15: Alerts list

Type and Description Code	Description	Details	Corrective Actions
100410	Integrity check failure in encrypted message	The AP cannot receive data from this client because the integrity check of the received message (MIC) has failed. Recommend checking the encryption setting on the client and on the AP.	Check the encryption setting on the client and on the OAW-IAP.
100511	DHCP request timed out	This client did not receive a response to its DHCP request in time. Recommend checking the status of the DHCP server in the network.	Check the status of the DHCP server in the network.
101012	Wrong Client VLAN	VLAN mismatch between the OAW-IAP and upstream device. Upstream device can be upstream switch or RADIUS server.	

IDS

The **IDS** link displays a list of foreign APs and foreign clients that are detected in the network. It consists of the following sections:

- Foreign Access Points Detected— Lists the APs that are not controlled by the Virtual Controller. The following information is displayed for each foreign AP:
 - MAC address— Displays the MAC address of the foreign AP.
 - Network— Displays the name of the network to which the foreign AP is connected.
 - Classification— Displays the classification of the foreign AP, for example, Interfering OAW-IAP or Rogue OAW-IAP.
 - Channel— Displays the channel in which the foreign AP is operating.
 - Type— Displays the Wi-Fi type of the foreign AP.
 - Last seen— Displays the time when the foreign AP was last detected in the network.
 - Where— Provides information about the OAW-IAP that detected the foreign AP. Click the pushpin icon to view the information.
- Foreign Clients Detected— Lists the clients that are not controlled by the Virtual Controller. The following information is displayed for each foreign client:
 - MAC address— Displays the MAC address of the foreign client.
 - Network— Displays the name of the network to which the foreign client is connected.
 - Classification— Displays the classification of the foreign client: Interfering client.
 - Channel— Displays the channel in which the foreign client is operating.
 - Type— Displays the Wi-Fi type of the foreign client.

- Last seen— Displays the time when the foreign client was last detected in the network.
- Where— Provides information about the OAW-IAP that detected the foreign client. Click the pushpin icon to view the information.

The following figure shows an example for the intrusion detection log.

Figure 21 *Intrusion Detection*

For more information on the intrusion detection feature, see [Intrusion Detection on page 331](#).

AirGroup

This **AirGroup** link provides an overall view of your AirGroup configuration. Click each field to view or edit the settings.

- **MAC**—Displays the MAC address of the AirGroup servers.
- **IP**—Displays the IP address of the AirGroup servers.
- **Host Name**—Displays the machine name or hostname of the AirGroup servers.
- **Service**— Displays the type of the services such as AirPlay or AirPrint.
- **VLAN**— Displays VLAN details of the AirGroup servers.
- **Wired/Wireless**—Displays if the AirGroup server is connected via wired or wireless interface.
- **Role**—Displays the user role if the server is connected through 802.1X authentication. If the server is connected through PSK or open authentication, this field is blank.
- **Group**—Displays the group.
- **CPPM**— By clicking on this, you get details of the registered rules in ClearPass Policy Manager (CPPM) for this server.
- **MDNS Cache**— By clicking on this, you receive MDNS record details of a particular server.

The following figure shows the AirGroup server details available on clicking the **AirGroup** link:

Figure 22 *AirGroup Link*

Configuration

The **Configuration** link provides an overall view of your Virtual Controller, Access Points, and WLAN SSID configuration. The following figure shows the Virtual Controller configuration details displayed on clicking the **Configuration** link.

Figure 23 Configuration Link

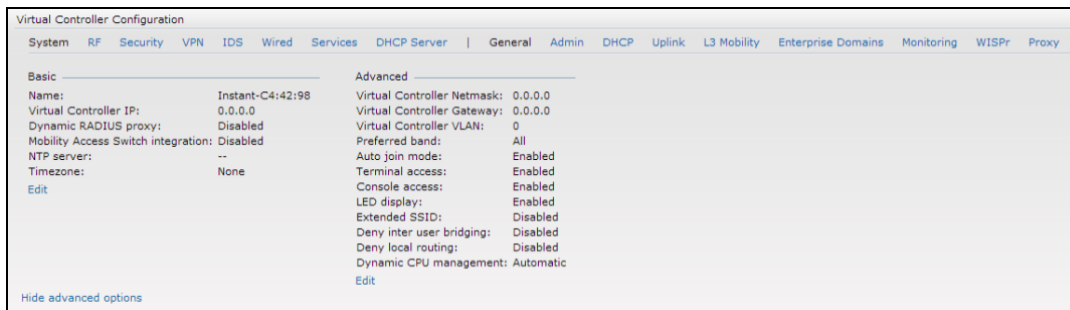

OmniVista 3600 Setup

OmniVista is a solution for managing rapidly changing wireless networks. When enabled, OmniVista allows you to manage the AOS-W Instant network. For more information on OmniVista, see [Managing an OAW-IAP from OmniVista on page 307](#). The OmniVista status is displayed at the bottom of the AOS-W Instant main window. If the OmniVista status is **Not Set Up**, click the **Set Up Now** link to configure OmniVista. The **System > Admin** window is displayed.

Pause/Resume

The **Pause/Resume** link is located at the bottom right corner of the AOS-W Instant main window.

Click the **Pause** link to pause the automatic refreshing of the AOS-W Instant UI after every 15 seconds by default. The AOS-W Instant UI is automatically refreshed after every 15 seconds by default. When the automatic refreshing is paused, the **Pause** link changes to **Resume**. Click the **Resume** link to resume automatic refreshing.

Automatic refreshing allows you to get the latest information about the network and network elements. You can use the **Pause** link when you want to analyze or monitor the network or a network element, and therefore do not want the user interface to refresh.

Views

Depending on the link or tab that is clicked, the AOS-W Instant displays information about the Virtual Controller, Wi-Fi networks, OAW-IAPs, or the clients in the Info section. The views on the AOS-W Instant main window are classified as follows:

- Virtual Controller view— The Virtual Controller view is the default view. This view allows you to monitor the AOS-W Instant network. This view allows you to monitor the AOS-W Instant network.
- The following AOS-W Instant UI elements are available in this view:
 - Tabs— Networks, Access Points, and Clients. For detailed information about the tabs, see [Tabs on page 45](#).
 - Links— Monitoring, Client Alerts, and IDS. The Spectrum link is visible if you have configured the OAW-IAP as a spectrum monitor. These links allow you to monitor the AOS-W Instant network. For more information about these links, see [Monitoring on page 54](#), [IDS on page 70](#), [Alerts on page 66](#), and [Spectrum Monitor on page 345](#).
- Network view— The Network view provides information that is necessary to monitor a selected wireless network. All Wi-Fi networks in the AOS-W Instant network are listed in the **Networks** tab. Click the name of the network that you want to monitor. Network view for the selected network is displayed.
- AOS-W Instant Access Point view— The AOS-W Instant Access Point view provides information that is necessary to monitor a selected OAW-IAP. All OAW-IAPs in the AOS-W Instant network are listed in the **Access Points** tab. Click the name of the OAW-IAP that you want to monitor. Access Point view for that OAW-IAP is displayed.

- Client view— The Client view provides information that is necessary to monitor a selected client. In the Client view, all the clients in the AOS-W Instant network are listed in the **Clients** tab. Click the IP address of the client that you want to monitor. Client view for that client is displayed.

For more information on the graphs and the views, see [Monitoring on page 54](#).

This chapter describes the general configuration tasks to perform when an OAW-IAP is set up.

- [Configuring System Parameters on page 74](#)
- [Changing Password on page 80](#)

Configuring System Parameters

This section describes how to configure the system parameters of an OAW-IAP.

To configure system parameters:

1. Select **System**. The **System** details are displayed.

Table 16: *System parameters*

Parameters	Description	CLI Configuration
Name	Name of the OAW-IAP.	(Instant AP) # name <name>
System location	Physical location of the OAW-IAP.	(Instant AP) # (config) # syslocation <location-name>
Virtual Controller IP	This field allows you to specify a single static IP address that can be used to manage a multi-AP AOS-W Instant network. This IP address is automatically provisioned on a shadow interface on the OAW-IAP that takes the role of a Virtual Controller. When an OAW-IAP becomes a Virtual Controller, it sends three Address Resolution Protocol (ARP) messages with the static IP address and its MAC address to update the network ARP cache.	(Instant AP) (config) # virtual- controller-ip <IP- address>
Dynamic Proxy	This field allows you to enable or disable dynamic proxy for RADIUS and TACACS servers. <ul style="list-style-type: none"> • Dynamic RADIUS proxy—When dynamic RADIUS proxy is enabled, the Virtual Controller network will use the IP address of the Virtual Controller for communication with external RADIUS servers. Ensure that you set the Virtual Controller IP address as a NAS client in the RADIUS server if Dynamic RADIUS proxy is enabled. • Dynamic TACACS proxy— When enabled, the Virtual Controller network will use the IP address of the Virtual Controller for communication with 	To enable dynamic RADIUS proxy: (Instant AP) (config) # dynamic-radius- proxy To enable TACACS proxy: (Instant AP) (config) # dynamic-tacacs- proxy

Table 16: System parameters

Parameters	Description	CLI Configuration
	<p>external TACACS servers. The IP address is chosen based on one of the following rules:</p> <p>If a VPN tunnel exists between the OAW-IAP and the TACACS server, then the IP address of the tunnel interface will be used.</p> <p>If a Virtual Controller IP address is configured, the the same will be used by the Virtual Controller network to communicate with the external TACACS server.</p> <p>If a Virtual Controller IP is not configured, then the IP address of the bridge interface is used.</p> <p>NOTE: When dynamic-tacacs-proxy is enabled on the OAW-IAP, the TACACS server cannot identify the slave OAW-IAP that generates the TACACS traffic as the source IP address is changed.</p>	
NTP Server	<p>This field allows you to configure NTP server. To facilitate communication between various elements in a network, time synchronization between the elements and across the network is critical. Time synchronization allows you to:</p> <ul style="list-style-type: none"> • Trace and track security gaps, network usage, and troubleshoot network issues. • Validate certificates. • Map an event on one network element to a corresponding event on another. • Maintain accurate time for billing services and similar. <p>Network Time Protocol (NTP) helps obtain the precise time from a server and regulate the local time in each network element. Connectivity to a valid NTP server is required to synchronize the OAW-IAP clock to set the correct time. If NTP server is not configured in the OAW-IAP network, an OAW-IAP reboot may lead to variation in time data.</p> <p>By default, the OAW-IAP tries to connect to pool.ntp.org to synchronize time. The NTP server can also be provisioned through the DHCP option 42. If the NTP server is configured, it takes precedence over the DHCP option 42 provisioned value. The NTP server provisioned through the DHCP option 42 is used if no server is configured. The default server pool.ntp.org is used if no NTP server is configured or provisioned through DHCP option 42.</p>	<p>To configure NTP server:</p> <pre>(Instant AP) (config) # ntp-server <name></pre>

Table 16: System parameters

Parameters	Description	CLI Configuration
	<p>NOTE: To facilitate zero-touch provisioning using the OmniVista Management Platform (AMP) or Activate, you must configure the firewall and wired infrastructure to either allow the NTP traffic to pool.ntp.org, or provide alternative NTP servers under DHCP options.</p>	
Timezone	<p>Timezone in which the OAW-IAP must operate. You can also enable daylight saving time (DST) on OAW-IAPs if the time zone you selected supports the daylight saving time. When enabled, the DST ensures that the OAW-IAPs reflect the seasonal time changes in the region they serve.</p>	<p>To configure timezone:</p> <pre>(AP) (config)# clock timezone <name> <hour-offset> <minute-offset></pre> <p>To configure daylight saving time:</p> <pre>(AP) (config)# clock summer-time <timezone> recurring <start-week> <start-day> <start-month> <start-hour> <end-week> <end-day> <end-month> <end-hour></pre>
Preferred Band	<p>The preferred band for the OAW-IAP.</p> <p>NOTE: Reboot the OAW-IAP after modifying the radio profile for changes to take effect.</p>	<pre>(AP) (config)# rf- band <band></pre>
AppRF Visibility	<p>Select one of the following options from the drop-down list for application visibility:</p> <ul style="list-style-type: none"> ● App—Displays only inbuilt Deep Packet Inspection (DPI) data. ● WebCC—Displays the DPI data hosted on the cloud. ● All—Displays both App and WebCC DPI data. ● None—Does not display any AppRF content. 	<pre>(AP) (config)# dpi</pre>
URL Visibility	<p>Select Enabled or Disabled from the drop-down list for full URL visibility.</p>	<pre>(AP)(config)# url-visibility</pre>
Virtual Controller network settings	<p>If the Virtual Controller IP address is in the same subnet as the OAW-IAP, ensure that you select Custom from the drop-down list and configure the following details:</p> <ul style="list-style-type: none"> ● Virtual Controller Netmask—Enter subnet mask details ● Virtual Controller Gateway—Enter a gateway address. 	<pre>(AP) (config)# virtual-controller- dnsip <addr> (AP) (config)# virtual-controller- vlan <vcvlan> <vcmask> <vcgw></pre>

Table 16: System parameters

Parameters	Description	CLI Configuration
	<ul style="list-style-type: none"> Virtual Controller DNS—If the DNS IP address is configured for a master OAW-IAP, the DNS IP settings are synchronized for all APs in an OAW-IAP cluster. <ul style="list-style-type: none"> If the DNS IP address is configured for an AP as part of the per AP setting (Edit Access Point >General) , it takes precedence over the Virtual Controller DNS IP address defined in the System > General window. If the APs are not explicitly assigned a DNS IP address, the DNS IP address defined in System > General takes precedence. If the DNS IP address is not defined for APs or Virtual Controller, the DNS address dynamically assigned from the DHCP server is used. Virtual Controller VLAN—Ensure that the VLAN defined for virtual controller is not the same as the native VLAN of the OAW-IAP. Virtual Controller VLAN, gateway, and subnet mask details. 	
Auto join mode	<p>The Auto Join mode feature allows OAW-IAPs to automatically discover the Virtual Controller and join the network. The Auto Join feature is enabled by default. If the auto join mode feature is disabled, a link is displayed in the Access Points tab indicating that there are new APs discovered in the network. Click this link if you want to add these APs to the network.</p> <p>When Auto Join feature is disabled, the inactive OAW-IAPs are displayed in red.</p>	<p>To disable auto join mode:</p> <pre>(Instant AP) (config) # no allow-new-aps</pre> <p>To enable auto join mode:</p> <pre>(Instant AP) (config) # allow-new-aps</pre>
Auto join mode	<p>When enabled, OAW-IAPs can automatically discover the VC and join the network. The auto join feature is enabled by default.</p> <p>If the auto join mode feature is disabled, a New link is displayed in the Access Points tab. Click this link to add OAW-IAPs to the network. If this feature is disabled, the inactive OAW-IAPs are displayed in red.</p>	<pre>(AP) (config) # allow-new-aps</pre>
Terminal access	<p>When terminal access is enabled, you can access the OAW-IAP CLI through SSH.</p> <p>The terminal access is enabled by default</p>	<pre>(AP) (config) # terminal-access</pre>

Table 16: System parameters

Parameters	Description	CLI Configuration
Console access	When enabled, you can access the OAW-IAP through the console port.	(AP) (config) # console
Telnet server	To start a Telnet session with the OAW-IAP CLI, enable access to the Telnet server.	(AP) (config) # telnet-server
LED display	LED display status of the OAW-IAP. Enable or disable LED display for all OAW-IAPs in a cluster, select Enabled or Disabled respectively. NOTE: The LED are always enabled during the OAW-IAP reboot.	(AP) (config) # led- off
Extended SSID	Extended SSID is enabled by default in the factory default settings of OAW-IAPs. This disables mesh in the factory default settings. <ul style="list-style-type: none">• The OAW-IAP175P/175AC, OAW-IAP104/105, and OAW-RAP108/109 support up to 6 SSIDs with Extended SSID disabled and up to 8 SSIDs with Extended SSID is enabled.• All other OAW-IAPs (excluding OAW-IAP175P/175AC, OAW-IAP104/105, and OAW-RAP108/109) support up to 14 SSIDs when Extended SSID is disabled and up to 16 SSIDs with Extended SSID enabled.	(AP) (config) # extended-ssid

Table 16: System parameters

Parameters	Description	CLI Configuration
Deny inter user bridging	<p>If you have security and traffic management policies defined in upstream devices, you can disable bridging traffic between two clients connected to the same AP on the same VLAN. When inter-user bridging is denied, the clients can connect to the Internet but cannot communicate with each other, and the bridging traffic between the clients is sent to the upstream device to make the forwarding decision.</p>	<pre>(AP) (config) # deny-inter-user-bridging</pre> <p>To disable inter-user bridging for the WLAN SSID clients:</p> <pre>(AP) (config) # wlan ssid-profile <ssid-profile> (AP) (SSID Profile <ssid-profile>) # deny-inter-user-bridging</pre>
Deny Local Routing	<p>If you have security and traffic management policies defined in upstream devices, you can disable routing traffic between two clients connected to the same OAW-IAP on different VLANs. When local routing is disabled, the clients can connect to the Internet but cannot communicate with each other, and the routing traffic between the clients is sent to the upstream device to make the forwarding decision.</p>	<pre>(AP) (config) # deny-local-routing</pre>
Dynamic CPU Utilization	<p>OAW-IAPs perform various functions such as wired and wireless client connectivity and traffic flows, wireless security, network management, and location tracking. If an AP is overloaded, prioritize the platform resources across different functions. Typically, the OAW-IAPs manage resources automatically in real time. However, under special circumstances, if dynamic resource management needs to be enforced or disabled altogether, the dynamic CPU management feature settings can be modified.</p> <p>To configure dynamic CPU management, select any of the following options from DYNAMIC CPU UTILIZATION.</p> <ul style="list-style-type: none"> ● Automatic—When selected, the CPU management is enabled or disabled automatically during run-time. This decision is based on real time load calculations taking into account all different functions that the CPU needs to perform. This is the default and recommended option. ● Always Disabled in all APs— When selected, this setting disables CPU management on all APs, typically for small networks. This setting protects user experience. 	

Table 16: *System parameters*

Parameters	Description	CLI Configuration
	<ul style="list-style-type: none">• Always Enabled in all APs—When selected, the client and network management functions are protected. This setting helps in large networks with high client density.	

Changing Password

You can update your password details by using the AOS-W Instant UI or the CLI.

In the AOS-W Instant UI

1. Navigate to **System>Admin**.
2. Under **Local**, provide a new password that you would like the admin users to use.
3. Click **OK**.

In the CLI

To change password for the admin user:

```
(Instant AP) (config)# mgmt-user <username> [password]
(Instant AP) (config)# end
(Instant AP)# commit apply
```

This chapter describes the procedures for configuring settings that are specific to an OAW-IAP in the cluster.

- [Modifying the OAW-IAP Hostname on page 81](#)
- [Configuring Zone Settings on an OAW-IAP on page 81](#)
- [Specifying a Method for Obtaining IP Address on page 82](#)
- [Configuring External Antenna on page 82](#)
- [Configuring Radio Profiles for an OAW-IAP on page 83](#)
- [Configuring Uplink VLAN for an OAW-IAP on page 85](#)
- [Master Election and Virtual Controller on page 86](#)
- [Adding an OAW-IAP to the Network on page 88](#)
- [Removing an OAW-IAP from the Network on page 88](#)

Modifying the OAW-IAP Hostname

You can change the hostname of an OAW-IAP through the AOS-W Instant UI or CLI.

In the AOS-W Instant UI

1. On the **Access Points** tab, click the OAW-IAP you want to rename. The **edit** link is displayed.
2. Click the **edit** link. The edit window for modifying OAW-IAP details is displayed.
3. Edit the OAW-IAP name in **Name**. You can specify a name of up to 32 ASCII characters.
4. Click **OK**.

In the CLI

To change the name:

```
(Instant AP) # hostname <name>
```

Configuring Zone Settings on an OAW-IAP

All APs in a cluster use the same SSID configuration including master and slave OAW-IAPs. However, if you want to assign an SSID to a specific OAW-IAP, you can configure zone settings for an OAW-IAP.

The following constraints apply to the AP zone configuration:

- An OAW-IAP can belong to only one zone and only one zone can be configured on an SSID.
- If an SSID belongs to a zone, all OAW-IAPs in this zone can broadcast this SSID. If no OAW-IAP belongs to the zone configured on the SSID, the SSID is not broadcast.
- If an SSID does not belong to any zone, all OAW-IAPs can broadcast this SSID.

You can add an AP zone by through the UI or CLI.



For the SSID to be assigned to an OAW-IAP, the same zone details must be configured on the SSID. For more information on SSID configuration, see [Configuring WLAN Settings for an SSID Profile on page 91](#).

In the AOS-W Instant UI

1. On the **Access Points** tab, click the OAW-IAP for which you want to set the zone. The **edit** link is displayed.

2. Click the **edit** link. The edit window for modifying OAW-IAP details is displayed.
3. Specify the AP zone in **Zone**.
4. Click **OK**.

In the CLI

To change the name:

```
(Instant AP) # zone <name>
```

Specifying a Method for Obtaining IP Address

You can either specify a static IP address or allow the OAW-IAP to obtain an IP address from the DHCP server. By default, the OAW-IAPs obtain IP address from the DHCP server. You can specify a static IP address for the OAW-IAP by using the AOS-W Instant UI or CLI.

In the AOS-W Instant UI

1. On the **Access Points** tab, click the OAW-IAP to modify. The **edit** link is displayed.
2. Click the **edit** link. The edit window for modifying the OAW-IAP details is displayed.
3. Select **Specify statically** option to specify a static IP address. The following fields are displayed:
 - a. Enter the new IP address for the OAW-IAP in the **IP address** text box.
 - b. Enter the subnet mask of the network in the **Netmask** text box.
 - c. Enter the IP address of the default gateway in the **Default gateway** text box.
 - d. Enter the IP address of the DNS server in the **DNS server** text box.
 - e. Enter the domain name in the **Domain name** text box.
4. Click **OK** and reboot the OAW-IAP.

In the CLI

To configure a static IP address:

```
(Instant AP) # ip-address <IP-address> <subnet-mask> <NextHop-IP> <DNS-IP-address> <domain-name>
```

Configuring External Antenna

If your OAW-IAP has external antenna connectors, you need to configure the transmit power of the system. The configuration must ensure that the system's Equivalent Isotropically Radiated Power (EIRP) is in compliance with the limit specified by the regulatory authority of the country in which the OAW-IAP is deployed. You can also measure or calculate additional attenuation between the device and antenna before configuring the antenna gain. To know if your AP device supports external antenna connectors, see the *Install Guide* that is shipped along with the AP device.

EIRP and Antenna Gain

The following formula can be used to calculate the EIRP limit related RF power based on selected antennas (antenna gain) and feeder (Coaxial Cable loss):

$$\text{EIRP} = \text{Tx RF Power (dBm)} + \text{GA (dB)} - \text{FL (dB)}$$

The following table describes this formula:

Table 17: *Formula Variable Definitions*

Formula Element	Description
EIRP	Limit specific for each country of deployment
Tx RF Power	RF power measured at RF connector of the unit
GA	Antenna gain
FL	Feeder loss

Example

For example, the maximum gain that can be configured on an OAW-IAP134 with AP-ANT-1 F dual-band and omni-directional antenna is as follows:

Table 18: *Maximum Antenna Gains*

Frequency Band	Gain (dBi)
2.4-2.5 GHz	2.0dBi
4.9-5.875GHz	5.0dBi

For information on antenna gain recommended by the manufacturer, see .

Configuring Antenna Gain

You can configure antenna gain for APs with external connectors using AOS-W Instant UI or CLI.

In the AOS-W Instant UI

1. Navigate to the **Access Point** tab, select the access point to configure, and then click **edit**.
2. In the **Edit Access Point** window, select **External Antenna** to configure the antenna gain value. This option is available only for access points that support external antennas, for example, OAW-IAP134.
3. Enter the antenna gain values in dBm for the 2.4GHz and 5GHz bands.
4. Click **OK**.

In the CLI

To configure external antenna for 5 GHz frequency:

```
(Instant AP) # a-external-antenna <dBi>
```

To configure external antenna for 2,4 GHz frequency:

```
(Instant AP) # g-external-antenna <dBi>
```

Configuring Radio Profiles for an OAW-IAP

You can configure a radio profile on an OAW-IAP either manually or by using the Adaptive Radio Management (ARM) feature.

ARM is enabled on AOS-W Instant by default. It automatically assigns appropriate channel and power settings for the OAW-IAPs. For more information on ARM, see [Adaptive Radio Management on page 257](#).

Configuring ARM Assigned Radio Profiles for an OAW-IAP

To enable ARM assigned radio profiles:

1. On the **Access Points** tab, click the OAW-IAP to modify. The **edit** link is displayed.
2. Click the **edit** link. The edit window for modifying OAW-IAP details is displayed.
3. Click the **Radio** tab. The **Radio** tab details are displayed.
4. Select the **Access** mode.
5. Select the **Adaptive radio management assigned** option under the bands that are applicable to the OAW-IAP configuration.
6. Click **OK**.

Configuring Radio Profiles Manually for OAW-IAP



When radio settings are assigned manually by the administrator, the ARM is disabled.

To manually configure radio settings:

1. On the **Access Points** tab, click the AP for which you want to enable ARM. The **edit** link is displayed.
2. Click the **edit** link. The **Edit Access Point** window is displayed.
3. Click the **Radio** tab.
4. Ensure that an appropriate mode is selected.

By default the channel and power for an AP are optimized dynamically using ARM. You can override ARM on the 2.4 GHz and 5 GHz bands and set the channel and power manually if desired. The following table describes various configuration modes for an AP:

Table 19: OAW-IAP Radio Modes

Mode	Description
Access	<p>In Access mode, the AP serves clients, while also monitoring for rogue APs in the background.</p> <p>If the Access mode is selected, perform the following actions:</p> <ol style="list-style-type: none">1. Select Administrator assigned in 2.4 GHz and 5 GHz band sections.2. Select appropriate channel number from the Channel drop-down list for both 2.4 GHz and 5 GHz band sections.3. Enter appropriate transmit power value in the Transmit power text box in 2.4 GHz and 5 GHz band sections.
Monitor	<p>In Monitor mode, the AP acts as a dedicated monitor, scanning all channels for rogue APs and clients. You can set one radio on the Monitor mode and the other radio on access mode, so that the clients can use one radio when the other one is in the Air Monitor mode.</p>
Spectrum Monitor	<p>In Spectrum Monitor mode, the AP functions as a dedicated full-spectrum RF monitor, scanning all channels to detect interference, whether from the neighboring APs or from non-WiFi devices such as microwaves and cordless phones.</p>



In the Spectrum Monitor mode, the APs do not provide access services to clients.

4. Click **OK**.

In the CLI

To configure a radio profile:

```
(Instant AP) # wifi0-mode {<access>|<monitor>|<spectrum-monitor>}  
(Instant AP) # wifi1-mode {<access>|<monitor>|<spectrum-monitor>}
```

If the access mode is configured, you can configure the channel and transmission power by running the following commands:

```
(Instant AP) # a-channel <channel> <tx-power>  
(Instant AP) # g-channel <channel> <tx-power>
```

You can also set the maximum number of clients that can connect to the 5 GHz and 2.4 GHz radio profiles by running the following commands:

```
(Instant AP) # a-max-clients <max-clients>  
(Instant AP) # g-max-clients <max-clients>
```

Configuring Uplink VLAN for an OAW-IAP

AOS-W Instant supports a management VLAN for the uplink traffic on an OAW-IAP. You can configure an uplink VLAN when an OAW-IAP needs to be managed from a non-native VLAN. After an OAW-IAP is provisioned with the uplink management VLAN, all management traffic sent from the OAW-IAP is tagged with the management VLAN.



Ensure that the native VLAN of the OAW-IAP and uplink are not the same.

You can configure the uplink management VLAN on an OAW-IAP by using the AOS-W Instant UI or CLI.

In the AOS-W Instant UI

To configure uplink management VLAN:

1. On the **Access Points** tab, click the OAW-IAP to modify. The **edit** link is displayed.
2. Click the **edit** link. The **edit** window for modifying OAW-IAP details is displayed.
3. Click the **Uplink** tab.
4. Specify the VLAN in the **Uplink Management VLAN** field.
5. Click **OK**.
6. Reboot the OAW-IAP.

In the CLI

To configure uplink VLAN:

```
(Instant AP) # uplink-vlan <VLAN-ID>
```

To view the uplink VLAN status:

```
(Instant AP) # show uplink-vlan  
Uplink Vlan Current :0  
Uplink Vlan Provisioned :1
```

Changing USB Port Status

The USB port can be enabled or disabled based on your uplink preferences. If you do not want to use the cellular uplink or 3G/4G modem in your current network setup, you can set the USB port status to disabled. By default, the USB port status is enabled.

You can change the USB port status in the AOS-W Instant UI or CLI.

In the AOS-W Instant UI

To change the USB port status:

1. From the **Access Points** tab, click the OAW-IAP to modify. The **edit** link is displayed.
2. Click the **edit** link. The **edit** window for modifying OAW-IAP details is displayed.
3. Click the **Uplink** tab.
4. Set the port status by selecting any of the following options:
 - **Disabled**—To disable the port status.
 - **Enabled**—To re-enable the port status.
5. Click **OK**.
6. Reboot the OAW-IAP.

In the CLI

To disable the USB port:

```
(Instant AP)# usb-port-disable
```

To re-enable the USB port:

```
(Instant AP)# no usb-port-disable
```

To view the USB port status:

```
(Instant AP)# show ap-env  
Antenna Type:External  
usb-port-disable:1
```

Master Election and Virtual Controller

AOS-W Instant does not require an external to regulate and manage the Wi-Fi network. Instead, one OAW-IAP in every network assumes the role of Virtual Controller. It coordinates, stores, and distributes the settings required to provide a centralized functionality to regulate and manage the Wi-Fi network. The Virtual Controller is the single point of configuration and firmware management. When configured, the Virtual Controller sets up and manages the VPN tunnel to a in the data center.

The Virtual Controller also functions like any other AP with full RF scalability. It also acts as a node, coordinating DHCP address allocation for network address translated clients ensuring mobility of the clients when they roam between different OAW-IAPs.

Master Election Protocol

The Master Election Protocol enables the AOS-W Instant network to dynamically elect an OAW-IAP to take on a Virtual Controller role and allow graceful failover to a new Virtual Controller when the existing Virtual Controller is not available. This protocol ensures stability of the network during initial startup or when the Virtual Controller goes down by allowing only one OAW-IAP to self-elect as a Virtual Controller.

Preference to an OAW-IAP with 3G/4G Card

The Master Election Protocol prefers the OAW-IAP with a 3G/4G card, when electing a Virtual Controller for the AOS-W Instant network during the initial setup. The Virtual Controller is selected based on the following criteria:

- If there is more than one OAW-IAP with 3G/4G cards, one of these OAW-IAPs is dynamically elected as the Virtual Controller.
- When an OAW-IAP without 3G/4G card is elected as the Virtual Controller but is up for less than 5 minutes, another OAW-IAP with 3G/4G card in the network is elected as the Virtual Controller to replace it and the previous Virtual Controller reboots.
- When an OAW-IAP without 3G/4G card is already elected as the Virtual Controller and is up for more than 5 minutes, the Virtual Controller will not be replaced until it goes down.



OAW-IAP135 is preferred over OAW-IAP105 when a Virtual Controller is elected.

Preference to an OAW-IAP with Non-Default IP

The Master Election Protocol prefers an OAW-IAP with non-default IP, when electing a Virtual Controller for the AOS-W Instant network during initial startup. If there are more than one OAW-IAP with non-default IPs in the network, all OAW-IAPs with default IP will automatically reboot and the DHCP process is used to assign new IP addresses.

Viewing Master Election Details

To verify the status of an OAW-IAP and master election details, use the following commands:

```
(Instant AP)# show election statistics  
(Instant AP)# show summary support
```

Manual Provisioning of Master OAW-IAP

In most cases, the master election process automatically determines the best OAW-IAP that can perform the role of Virtual Controller, which will apply its image and configuration to all other OAW-IAPs in the same AP management VLAN. When the Virtual Controller goes down, a new Virtual Controller is elected.

Provisioning an OAW-IAP as a Master OAW-IAP

You can provision an OAW-IAP as a master OAW-IAP by using the AOS-W Instant UI or CLI.

In the AOS-W Instant UI

1. On the **Access Points** tab, click the OAW-IAP to modify. The **edit** link is displayed.
2. Click the **edit** link. The edit window for modifying OAW-IAP details is displayed.
3. Select **Enabled** from **Preferred master** drop-down. This option is disabled by default.

Figure 24 OAW-IAP Settings—Provisioning Master OAW-IAP

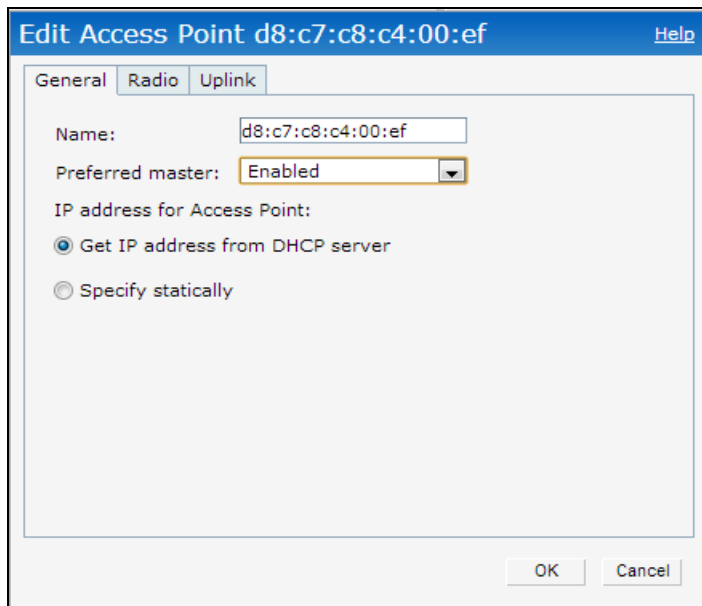

4. Click **OK**.

In the CLI

To provision an OAW-IAP as a master OAW-IAP:

```
(Instant AP)# iap-master
```

To verify if the OAW-IAP is provisioned as master IAP:

```
(Instant AP)# show ap-env  
Antenna Type:Internal  
Iap_master:1
```

Adding an OAW-IAP to the Network

To add an OAW-IAP to the Instant network, assign an IP address. For more information, see [Assigning an IP address to the OAW-IAP on page 34](#).

After an OAW-IAP is connected to the network, if the Auto Join Mode feature is enabled, the OAW-IAP inherits the configuration from the Virtual Controller and is listed in the **Access Points** tab.

If the Auto Join Mode is disabled, perform the following steps to add an OAW-IAP to the network:

1. On the **Access Points** tab, click the **New** link. The **New Access Point** window is displayed.
2. In the **New Access Point** window, enter the MAC address for the new OAW-IAP.
3. Click **OK**.

Removing an OAW-IAP from the Network

You can remove an OAW-IAP from the network only if the Auto Join Mode feature is disabled. To remove an OAW-IAP from the network:

1. On the **Access Points** tab, click the OAW-IAP to delete. The **x** icon is displayed against the OAW-IAP.
2. Click **x** to confirm the deletion.



The deleted OAW-IAPs cannot join the Instant network anymore and no longer are displayed in the AOS-W Instant UI. However, the master OAW-IAP details cannot be deleted from the Virtual Controller database.

VLAN configuration is required for networks with more devices and broadcast traffic on a WLAN SSID or wired profile. Based on the network type and its requirements, you can configure the VLANs for a WLAN SSID or wired port profile.

For more information on VLAN configuration for a WLAN SSID and wired port profile, see [Configuring VLAN Settings for a WLAN SSID Profile on page 95](#) and [Configuring VLAN for a Wired Profile on page 116](#).

VLAN Pooling

In a single OAW-IAP cluster, a large number of clients can be assigned to the same VLAN. Using the same VLAN for multiple clients can lead to a high level of broadcasts in the same subnet. To manage the broadcast traffic, you can partition the network into different subnets and use L3-mobility between those subnets when clients roam. However, if a large number of clients need to be in the same subnet, you can configure VLAN pooling, in which each client is randomly assigned a VLAN from a pool of VLANs on the same SSID. Thus, VLAN pooling allows automatic partitioning of a single broadcast domain of clients into multiple VLANs.

Uplink VLAN Monitoring and Detection on Upstream Devices

If a client connects to an SSID or wired interface with a VLAN that is not allowed on the upstream device, the client will not be assigned an IP address and thus cannot connect to the Internet. When a client connects to an SSID or a wired interface with VLAN that is not allowed on the upstream device, the AOS-W Instant UI now displays the following alert message:

Figure 25 Uplink VLAN Detection

Instant-CC:42:39					
Client Alerts					
Timestamp	MAC address	Description	Alert ID	Severity	Action
2013/11/11 11:50:30	b4:b6:76:42:6d:05	Wrong Client VLAN	6c:f3:7f:c4:42:ce	more	more
2013/11/11 11:50:30	b4:b6:76:42:6d:05	DHCP request timed out	6c:f3:7f:c4:42:ce	more	more

To resolve this issue, ensure that there is no mismatch in the VLAN configuration.

This chapter provides the following information:

- [Configuring Wireless Network Profiles on page 90](#)
- [Configuring Fast Roaming for Wireless Clients on page 108](#)
- [Configuring Modulation Rates on a WLAN SSID on page 112](#)
- [Disabling Short Preamble for Wireless Client](#)
- [Editing Status of a WLAN SSID Profile on page 113](#)
- [Editing a WLAN SSID Profile on page 114](#)
- [Deleting a WLAN SSID Profile on page 114](#)

Configuring Wireless Network Profiles

During start up, a wireless client searches for radio signals or beacon frames that originate from the nearest OAW-IAP. After locating the OAW-IAP, the following transactions take place between the client and the OAW-IAP:

1. Authentication—The OAW-IAP communicates with a RADIUS server to validate or authenticate the client.
2. Connection—After successful authentication, the client establishes a connection with the OAW-IAP.

Network Types

AOS-W Instant wireless networks are categorized as:

- **Employee network**—An Employee network is a classic Wi-Fi network. This network type is used by the employees in an organization and it supports passphrase-based or 802.1X based authentication methods. Employees can access the protected data of an enterprise through the employee network after successful authentication. The employee network is selected by default during a network profile configuration.
- **Voice network**—This Voice network type allows you to configure a network profile for devices that provide only voice services such as handsets or applications that require voice traffic prioritization.
- **Guest network**—The Guest wireless network is created for guests, visitors, contractors, and any non-employee users who use the enterprise Wi-Fi network. The Virtual Controller assigns the IP address for the guest clients. Captive portal or passphrase based authentication methods can be set for this wireless network. Typically, a guest network is an un-encrypted network. However, you can specify the encryption settings when configuring a guest network.



When a client is associated to the Voice network, all data traffic is marked and placed into the high priority queue in QoS (Quality of Service).

To configure a new wireless network profile, complete the following procedures:

1. [Configuring WLAN Settings](#)
2. [Configuring VLAN Settings](#)
3. [Configuring Security Settings](#)
4. [Configuring Access Rules for a Network](#)

Configuring WLAN Settings for an SSID Profile

You can configure WLAN settings using the AOS-W Instant UI or CLI.

In the AOS-W Instant UI

To configure WLAN settings:

1. In the **Networks** tab of the AOS-W Instant main window, click the **New** link. The **New WLAN** window is displayed. The following figure shows the contents of the **WLAN Settings** tab:

Figure 26 WLAN Settings Tab

The screenshot shows the 'WLAN Settings' configuration window. The 'Name' field is set to 'test'. Under 'Primary usage', 'Employee' is selected. In the 'Broadcast/Multicast' section, 'Broadcast filtering' is set to 'ARP', and both 'Multicast transmission optimization' and 'Dynamic multicast optimization' are set to 'Disabled'. The 'Transmit Rates' section shows 2.4 GHz and 5 GHz settings with Min: 1 and Max: 54. The 'Bandwidth Limits' section has 'Airtime' and 'Each radio' checkboxes. The 'WMM' section has percentage fields for Background, Best effort, Video, and Voice WMM. The 'Traffic Specification (TSPEC)' section has 'TSPEC Bandwidth' set to 2000 Kbps. The 'Miscellaneous' section includes 'Content filtering' (Disabled), 'Inactivity timeout' (1000 sec), 'Deauth inactive clients' (Disabled), 'SSID' (Hide), 'Out of service (OOS)' (VPN down), 'OOS time (global)' (30 sec), 'Max clients threshold', 'SSID encoding' (Default), and 'Deny inter user bridging' (Disabled). A 'Next' button is at the bottom right.

2. Enter a name that uniquely identifies a wireless network in the **Name (SSID)** text box.



The SSID name must be unique and may contain any special character except for ' and ''.

3. Based on the type of network profile, select any of the following options under **Primary usage**:
 - **Employee**
 - **Voice**
 - **Guest**
4. Click the **Show advanced options** link. The advanced options for configuration are displayed. Specify the following parameters as required.

Table 20: WLAN Configuration Parameters

Parameter	Description
Broadcast filtering	<p>Select any of the following values:</p> <ul style="list-style-type: none"> • All—When set to All, the OAW-IAP drops all broadcast and multicast frames except DHCP and ARP, IGMP group queries, and IPv6 neighbor discovery protocols. • ARP—When set to ARP, the OAW-IAP drops all broadcast and multicast frames except DHCP and ARP, IGMP group queries, and IPv6 neighbor discovery protocols and additionally converts ARP requests to unicast and send frames directly to the associated client. • Disabled— When set to Disabled, all broadcast and multicast traffic is forwarded to the wireless interfaces.
Multicast transmission optimization	<p>Select Enabled if you want the OAW-IAP to select the optimal rate for sending broadcast and multicast frames based on the lowest of unicast rates across all associated clients. When this option is enabled, multicast traffic can be sent at up to 24 Mbps. The default rate for sending frames for 2.4 GHz is 1 Mbps and 5.0 GHz is 6 Mbps. This option is disabled by default.</p>
Dynamic multicast optimization	<p>Select Enabled to allow OAW-IAP to convert multicast streams into unicast streams over the wireless link. Enabling Dynamic Multicast Optimization (DMO) enhances the quality and reliability of streaming video, while preserving the bandwidth available to the non-video clients.</p> <p>NOTE: When you enable DMO on multicast SSID profiles, ensure that the DMO feature is enabled on all SSIDs configured in the same VLAN.</p>
DMO channel utilization threshold	<p>Specify a value to set a threshold for DMO channel utilization. With DMO, the OAW-IAP converts multicast streams into unicast streams as long as the channel utilization does not exceed this threshold. The default value is 90% and the maximum threshold value is 100%. When the threshold is reached or exceeds the maximum value, the OAW-IAP sends multicast traffic over the wireless link.</p>
Transmit Rates	<p>Specify the following parameters:</p> <ul style="list-style-type: none"> • 2.4 GHz—If the 2.4 GHz band is configured on the OAW-IAP, specify the minimum and maximum transmission rate. The default value for minimum transmission rate is 1 Mbps and maximum transmission rate is 54 Mbps. • 5 GHz—If the 5 GHz band is configured on the OAW-IAP, specify the minimum and maximum transmission rate. The default value for minimum transmission rate is 6 Mbps and maximum transmission rate is 54 Mbps.
Band	<p>Select a value to specify the band at which the network transmits radio signals. You can set the band to 2.4 GHz, 5 GHz, or All. The All option is selected by default.</p>
DTIM interval	<p>The DTIM interval indicates the delivery traffic indication message (DTIM) period in beacons, which can be configured for every WLAN SSID profile. The DTIM interval determines how often the OAW-IAP should deliver the buffered broadcast and multicast frames to associated clients in the powersave mode. The default value is 1, which means the client checks for buffered data on the OAW-IAP at every beacon. You can also configure a higher DTIM value for power saving.</p>

Table 20: WLAN Configuration Parameters

Parameter	Description
Min RSSI probe request	Sets a minimum Received signal strength indication (RSSI) threshold for probe requests.
Min RSSI auth request	Sets a minimum RSSI threshold for authentication requests.
Very high throughput	<p>Enables VHT function on OAW-IAP devices that support VHT. For 802.11ac OAW-IAPs, the VHT function is enabled by default. However, you can disable the VHT function if you want the 802.11ac OAW-IAPs to function as 802.11n OAW-IAPs.</p> <p>If VHT is configured or disabled on an SSID, the changes will apply only to the SSID on which it is enabled or disabled.</p>
Zone	<p>Specify the zone for the SSID. When the zone is defined in SSID profile and if the same zone is defined on an OAW-IAP, the SSID is created on that OAW-IAP. For more information on configuring zone details, see Configuring Zone Settings on an OAW-IAP on page 81.</p> <p>The following constraints apply to the zone configuration:</p> <ul style="list-style-type: none"> • An OAW-IAP can belong to only one zone and only one zone can be configured on an SSID. • If an SSID belongs to a zone, all OAW-IAPs in this zone can broadcast this SSID. If no OAW-IAP belongs to the zone configured on the SSID, the SSID is not broadcast. • If an SSID does not belong to any zone, all OAW-IAPs can broadcast this SSID.
Time Range	Click Edit , select a Time Range Profile from the list and specify if the profile must be enabled or disabled for the SSID, and then click OK .
Bandwidth Limits	<p>Under Bandwidth Limits:</p> <ul style="list-style-type: none"> • Airtime—Select this checkbox to specify an aggregate amount of airtime that all clients in this network can use for sending and receiving data. Specify the airtime percentage. • Each radio— Select this checkbox to specify an aggregate amount of throughput that each radio is allowed to provide for the connected clients. • Downstream and Upstream—Specify the downstream and upstream rates within a range of 1 to 65535 Kbps for the SSID users. If the assignment is specific for each user, select the Peruser checkbox.
Wi-Fi Multimedia (WMM) traffic management	<p>Configure the following options for WMM traffic management. WMM supports voice, video, best effort, and background access categories. To allocate bandwidth for the following types of traffic, specify a percentage value under Share. To configure DSCP mapping, specify a value under DSCP Mapping.</p> <ul style="list-style-type: none"> • Background WMM—For background traffic such as file downloads or print jobs. • Best effort WMM—For best effort traffic such as traffic from legacy devices or traffic from applications or devices that do not support QoS. • Video WMM—For video traffic generated from video streaming. • Voice WMM— For voice traffic generated from the incoming and outgoing voice communication.

Table 20: WLAN Configuration Parameters

Parameter	Description
	<p>For more information on WMM traffic and DSCP mapping, see Wi-Fi Multimedia Traffic Management on page 280</p> <p>For voice traffic and Spectralink Voice Prioritization, configure the following parameters:</p> <ul style="list-style-type: none"> • Traffic Specification (TSPEC)—To prioritize time-sensitive traffic such as voice traffic initiated by the client, select the Traffic Specification (TSPEC) check box. • TSPEC Bandwidth—To reserve bandwidth, set the TPSEC bandwidth to the desired value within the range of 200–600000 Kbps. The default value is 2000 Kbps. • Spectralink Voice Protocol (SVP)—Select the check box to prioritize voice traffic for SVP handsets.
Content filtering	Select Enabled to route all DNS requests for the non-corporate domains to OpenDNS on this network.
Inactivity timeout	Specify an interval for session timeout in seconds, minutes or hours. If a client session is inactive for the specified duration, the session expires and the users are required to log in again. You can specify a value within the range of 60-86400 seconds or up to 24 hours for a client session. The default value is 1000 seconds.
Deauth Inactive Clients	Select Enabled to allow the OAW-IAP to send a deauthentication frame to the inactive client and clear client entry.
SSID	Select the Hide checkbox if you do not want the SSID (network name) to be visible to users. Select the Disable checkbox if you want to disable the SSID. On selecting this, the SSID will be disabled, but will not be removed from the network. By default, all SSIDs are enabled.
Out of service (OOS)	<p>Enable or disable the SSID based on the following out of service states of the OAW-IAP:</p> <ul style="list-style-type: none"> • VPN down • Uplink down • Internet down • Primary uplink down <p>The network will be out of service when selected event occurs and the SSID is enabled or disabled as per the configuration settings applied. For example, if you select the VPN down option from the drop-down list and set the status to enabled, the SSID is enabled when the VPN connection is down and is disabled when the VPN connection is restored.</p>
OOS time (global)	Configure a hold time interval in seconds within a range of 30 to 300 seconds, after which the out-of-service operation is triggered. For example, if the VPN is down and the configured hold time is 45 seconds, the effect of this out-of-service state impacts the SSID availability after 45 seconds.
Max clients threshold	Specify the maximum number of clients that can be configured for each BSSID on a WLAN. You can specify a value within the range of 0 to 255. The default value is 64.

Table 20: WLAN Configuration Parameters

Parameter	Description
SSID Encoding	To encode the SSID, select UTF8. By default, the SSIDs are not encoded.
Deny inter user bridging	When enabled, the bridging traffic between two clients connected to the same SSID on the same VLAN is disabled. The clients can connect to the Internet, but cannot communicate with each other, and the bridging traffic between the clients is sent to the upstream device to make the forwarding decision.
ESSID	Enter the ESSID. If the value defined for ESSID value is not the same as profile name, the SSIDs can be searched based on the ESSID value and not by its profile name.

5. Click **Next** to configure VLAN settings. For more information, see [Configuring VLAN Settings for a WLAN SSID Profile on page 95](#).

In the CLI

To configure WLAN settings for an SSID profile:

```
(Instant AP) (config)# wlan ssid-profile <name>
(Instant AP) (SSID Profile <name>)# essid <ESSID-name>
(Instant AP) (SSID Profile <name>)# type {<Employee>|<Voice>| <Guest>}
(Instant AP) (SSID Profile <name>)# broadcast-filter <type>
(Instant AP) (SSID Profile <name>)# dtim-period <number-of-beacons>
(Instant AP) (SSID Profile <name>)# multicast-rate-optimization
(Instant AP) (SSID Profile <name>)# dynamic-multicast-optimization
(Instant AP) (SSID Profile <name>)# dmo-channel-utilization-threshold
(Instant AP) (SSID Profile <name>)# a-max-tx-rate <rate>
(Instant AP) (SSID Profile <name>)# a-min-tx-rate <rate>
(Instant AP) (SSID Profile <name>)# g-max-tx-rate <rate>
(Instant AP) (SSID Profile <name>)# g-min-tx-rate <rate>
(Instant AP) (SSID Profile <name>)# zone <zone>
(Instant AP) (SSID Profile <name>)# bandwidth-limit <limit>
(Instant AP) (SSID Profile <name>)# per-user-bandwidth-limit <limit>
(Instant AP) (SSID Profile <name>)# air-time-limit <limit>
(Instant AP) (SSID Profile <name>)# wmm-background-dscp <dscp>
(Instant AP) (SSID Profile <name>)# wmm-background-share <share>
(Instant AP) (SSID Profile <name>)# wmm-best-effort-dscp <dscp>
(Instant AP) (SSID Profile <name>)# wmm-best-effort-share <share>
(Instant AP) (SSID Profile <name>)# wmm-video-dscp <dscp>
(Instant AP) (SSID Profile <name>)# wmm-video-share <share>
(Instant AP) (SSID Profile <name>)# wmm-voice-dscp <dscp>
(Instant AP) (SSID Profile <name>)# wmm-voice-share <share>
(Instant AP) (SSID Profile <name>)# rf-band {<2.4>|<5.0>|<all>}
(Instant AP) (SSID Profile <name>)# content-filtering
(Instant AP) (SSID Profile <name>)# hide-ssid
(Instant AP) (SSID Profile <name>)# out-of-service <def> <name>
(Instant AP) (SSID Profile <name>)# time-range <profile name> {<Enable>|<Disable>}
(Instant AP) (SSID Profile <name>)# inactivity-timeout <interval>
(Instant AP) (SSID Profile <name>)# local-probe-req-thresh <threshold>
(Instant AP) (SSID Profile <name>)# max-clients-threshold <number-of-clients>
(Instant AP) (SSID Profile <name>)# end
(Instant AP)# commit apply
```

Configuring VLAN Settings for a WLAN SSID Profile

If you are creating a new SSID profile, complete the WLAN Settings procedure before configuring VLAN. For more information, see [Configuring WLAN Settings for an SSID Profile on page 91](#).

You can configure VLAN settings for an SSID profile using the AOS-W Instant UI or CLI.

In the AOS-W Instant UI

To configure VLAN settings for an SSID:

1. In the **VLAN** tab of the **New WLAN** window, perform the following steps. The following figure displays the contents of the **VLAN** tab.

Figure 27 VLAN Tab

The screenshot shows the 'New WLAN' configuration window with the 'VLAN' tab selected. The window title is 'New WLAN' with a 'Help' link. The navigation bar shows four tabs: '1 WLAN Settings', '2 VLAN' (active), '3 Security', and '4 Access'. The main content area is titled 'Client IP & VLAN Assignment'. It contains two sections of radio button options: 'Client IP assignment' with 'Virtual Controller assigned' and 'Network assigned' (selected), and 'Client VLAN assignment' with 'Default', 'Static', and 'Dynamic' (selected). Below these is a 'VLAN Assignment Rules' section with a text box containing 'Default VLAN: 1'. At the bottom of this section are 'New', 'Edit', 'Delete', and two arrow buttons. At the very bottom of the window are 'Back', 'Next', and 'Cancel' buttons.

2. Select any for the following options for **Client IP assignment**:
 - **Virtual Controller assigned**—On selecting this option, the client obtains the IP address from the Virtual Controller.
 - **Network assigned**—On selecting this option, the IP address is obtained from the network.
3. Based on the type client IP assignment mode selected, you can configure the VLAN assignment for clients as described in the following table:

Table 21: IP and VLAN Assignment for WLAN SSID Clients

Client IP Assignment	Client VLAN Assignment
Virtual Controller assigned	<p>If Virtual Controller assigned is selected for client IP assignment, the Virtual Controller creates a private subnet and VLAN on the OAW-IAP for the wireless clients. The network address translation for all client traffic that goes out of this interface is carried out at the source. This setup eliminates the need for complex VLAN and IP address management for a multi-site wireless network.</p> <p>On selecting this option, the following client VLAN assignment options are displayed:</p> <ul style="list-style-type: none"> • Default: When selected, the default VLAN as determined by the Virtual Controller is assigned for clients. • Custom: When selected, you can specify a custom VLAN assignment option. You can select an existing DHCP scope for client IP and VLAN assignment or you can create a new DHCP scope by selecting New. For more information on DHCP scopes, see Configuring DHCP Scopes on page 215.
Network assigned	<p>If Network assigned is selected, you can specify any of the following options for the Client VLAN assignment.</p> <ul style="list-style-type: none"> • Default— On selecting this option, the client obtains the IP address in the same subnet as the OAW-IAPs. By default, the client VLAN is assigned to the native VLAN on the wired network. • Static— On selecting this option, you need to specify a single VLAN, a comma separated list of VLANs, or a range of VLANs for all clients on this network. Select this option for configuring VLAN pooling. • Dynamic— On selecting this option, you can assign the VLANs dynamically from a Dynamic Host Configuration Protocol (DHCP) server. To create VLAN assignment rules, click New to assign the user to a VLAN. In the New VLAN Assignment Rule window, enter the following information: <ul style="list-style-type: none"> • Attribute— Select an attribute returned by the RADIUS server during authentication. • Operator— Select an operator for matching the string. • String— Enter the string to match • VLAN— Enter the VLAN to be assigned.

4. Click **Next** to configure security settings for the employee network. For more information, see [Configuring Security Settings for a WLAN SSID Profile on page 98](#).

In the CLI

To manually assign VLANs for WLAN SSID users:

```
(Instant AP) (config)# wlan ssid-profile <name>
(Instant AP) (SSID Profile <name>)# vlan <vlan-ID>
(Instant AP) (SSID Profile <name>)# end
(Instant AP)# commit apply
```

To create a new VLAN assignment rule:

```
(Instant AP) (config)# wlan ssid-profile <name>
(Instant AP) (SSID Profile <name>)# set-vlan <attribute> {{contains|ends-with|equals|matches-regular-expression|not-equals|starts-with} <operand> <vlan>|value-of}
(Instant AP) (SSID Profile <name>)# end
(Instant AP)# commit apply
```

Enforcing DHCP

In AOS-W Instant 6.4.3.4-4.2.1.0, you can configure a WLAN SSID profile to enforce DHCP on OAW-IAP clients.

When DHCP is enforced:

- A layer-2 user entry is created when a client associates with an OAW-IAP.
- The client DHCP state and IP address are tracked.
- When the client obtains an IP address from DHCP, the DHCP state changes to complete.
- If the DHCP state is complete, a layer-3 user entry is created.
- When a client roams between the OAW-IAPs, the DHCP state and the client IP address will be synchronized with the new OAW-IAP.

By default, enforcing DHCP feature is disabled.

To enforce DHCP:

```
(Instant AP) (config)# wlan ssid-profile <name>
(Instant AP) (SSID Profile <name>)# enforce-dhcp
(Instant AP) (SSID Profile <name>)# end
(Instant AP)# commit apply
```

Configuring Security Settings for a WLAN SSID Profile

This section describes the procedure for configuring security settings for an employee or voice network. For information on guest network configuration, see [Captive Portal for Guest Access](#).



If you are creating a new SSID profile, configure the WLAN and VLAN settings before defining security settings. For more information, see [Configuring WLAN Settings for an SSID Profile on page 91](#) and [Configuring VLAN Settings for a WLAN SSID Profile on page 95](#).

Configuring Security Settings for an Employee or Voice Network

You can configure security settings for an employee or voice network by using the AOS-W Instant UI or CLI.

In the AOS-W Instant UI

To configure security settings for an employee or voice network:

1. On the **Security** tab, specify any of the following types of security levels by moving the slider to a desired level:
 - **Enterprise**—On selecting enterprise security level, the authentication options applicable to the enterprise network are displayed.
 - **Personal**—On selecting personal security level, the authentication options applicable to the personalized network are displayed.
 - **Open**—On selecting Open security level, the authentication options applicable to an open network are displayed:

The default security setting for a network profile is **Personal**.

The following figures show the configuration options for **Enterprise**, **Personal**, and **Open** security settings:

Figure 28 Security Tab: Enterprise

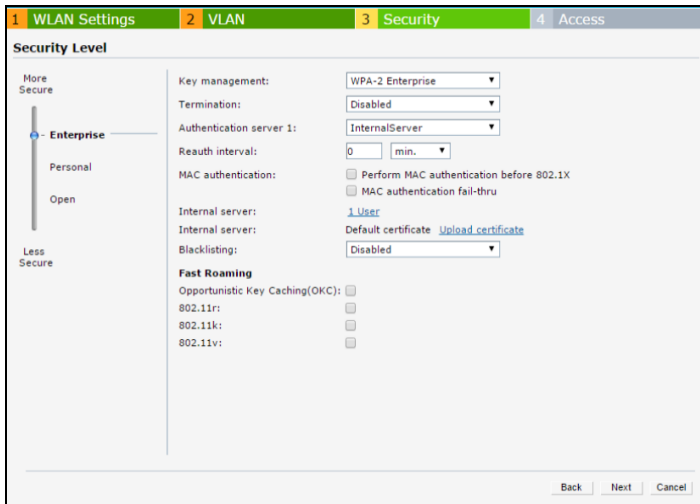

Figure 29 Security Tab: Personal

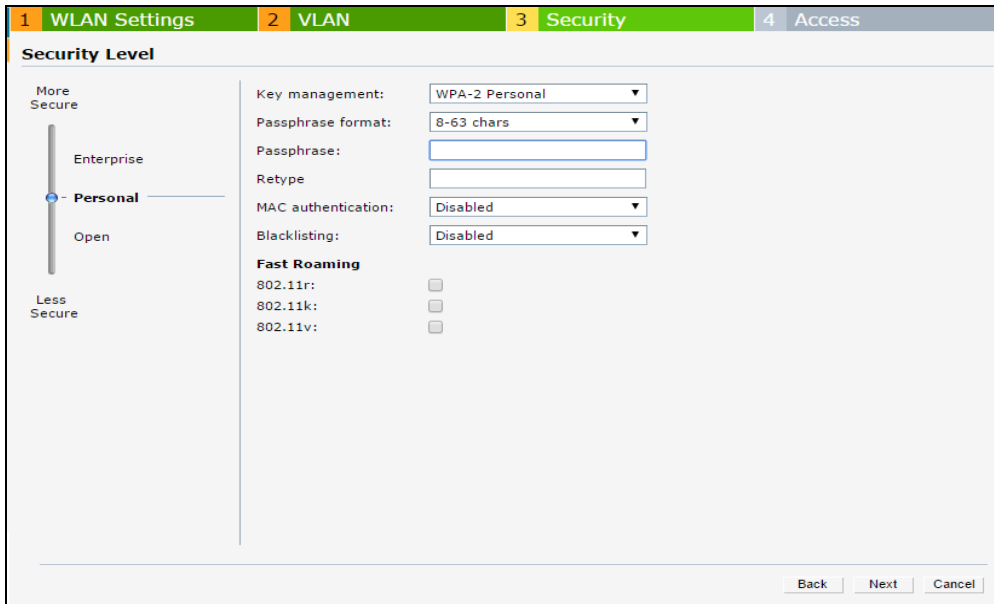
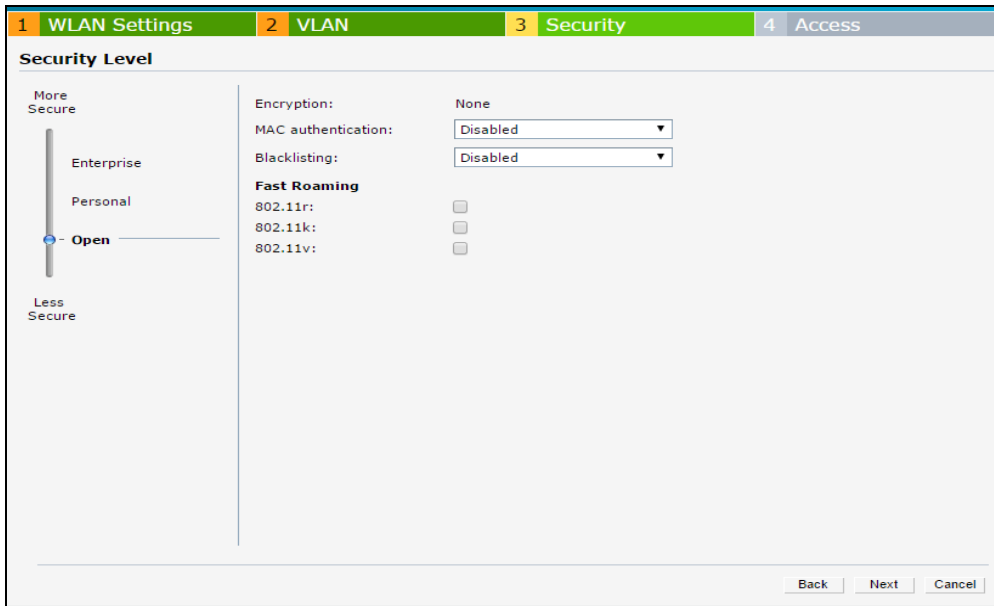

Figure 30 *Security Tab: Open*



2. Based on the security level specified, specify the following parameters:

Table 22: Configuration Parameters for WLAN Security Settings in an Employee or Voice Network

Parameter	Description	Security Level Type
Key Management	<p>For Enterprise security level, select any of the following options from the Key management drop-down list:</p> <ul style="list-style-type: none"> ● WPA-2 Enterprise ● WPA Enterprise ● Both (WPA-2 & WPA) ● Dynamic WEP with 802.1X—If you do not want to use a session key from the RADIUS Server to derive pair wise unicast keys, set Session Key for LEAP to Enabled. This is required for old printers that use dynamic WEP through Lightweight Extensible Authentication Protocol (LEAP) authentication. The Session Key for LEAP feature is set to Disabled by default. <p>For Personal security level, select any of the following encryption keys from the Key management drop-down list.</p> <ul style="list-style-type: none"> ● WPA-2 Personal ● WPA-Personal (Both TKIP and AES Encryption) ● WPA-Personal (TKIP Encryption only) ● WPA-Personal (AES Encryption only) ● Both (WPA-2 &WPA) ● Static WEP <p>If a WPA-2, WPA encryption, or Both (WPA-2&WPA) is selected, configure the passphrase:</p> <ol style="list-style-type: none"> 1. Select a passphrase format from the Passphrase format drop-down list. The options are available are 8-63 alphanumeric characters and 64 hexadecimal characters. 2. Enter a passphrase in the Passphrase text box and reconfirm. <p>NOTE: The Passphrase may contain any special character except for " .</p> <p>For Static WEP, specify the following parameters:</p> <ol style="list-style-type: none"> 1. Select an appropriate value for WEP key size from the WEP key size drop-down list. You can specify 64-bit or 128-bit . 2. Select an appropriate value for Tx key from the Tx Key drop-down list. You can specify 1, 2, 3, or 4. 3. Enter an appropriate WEP key and reconfirm. 	<p>Applicable to Enterprise and Personal security levels only.</p> <p>For the Open security level, no encryption settings are required.</p>
Termination	<p>To terminate the EAP portion of 802.1X authentication on the OAW-IAP instead of the RADIUS server, set Termination to Enabled. Enabling Termination can reduce network traffic to the external RADIUS server by terminating the authorization protocol on the OAW-IAP. By default, for 802.1X authorization, the client conducts an EAP exchange with the RADIUS server, and the OAW-IAP acts as a relay for this exchange.</p> <p>When Termination is enabled, the OAW-IAP by itself acts as an authentication server and terminates the outer layers of the EAP protocol, only relaying the innermost layer to the external RADIUS server. It can also</p>	<p>Enterprise security level</p>

Table 22: Configuration Parameters for WLAN Security Settings in an Employee or Voice Network

Parameter	Description	Security Level Type
	<p>reduce the number of exchange packets between the OAW-IAP and authentication server.</p> <p>NOTE: AOS-W Instant supports the configuration of primary and backup authentication servers in an EAP termination enabled SSID.</p> <p>NOTE: If you are using LDAP for authentication, ensure that AP termination is configured to support EAP.</p>	
Authentication server 1 and Authentication server 2	<p>Select any of the following options from the Authentication server 1 drop-down list:</p> <ul style="list-style-type: none"> • Select an authentication server from the list if an external server is already configured. To modify the server parameters, click Edit. • Select New to add a new server. For information on configuring external servers, see Configuring an External Server for Authentication on page 163. • To use an internal server, select Internal server and add the clients that are required to authenticate with the internal RADIUS server. Click the Users link to add the users. For information on adding a user, see Managing OAW-IAP Users on page 150. <p>If an external server is selected, you can also configure another authentication server.</p>	Enterprise , Personal, and Open security levels.
Load balancing	<p>Set this to Enabled if you are using two RADIUS authentication servers, so that the load across the two RADIUS servers is balanced. For more information on the dynamic load balancing mechanism, see Dynamic Load Balancing between Two Authentication Servers on page 163.</p>	Enterprise , Personal, and Open security levels.
Reauth interval	<p>Specify a value for Reauth interval. When set to a value greater than zero, APs periodically reauthenticate all associated and authenticated clients.</p> <p>If the reauthentication interval is configured:</p> <ul style="list-style-type: none"> • On an SSID performing L2 authentication (MAC or 802.1X authentication)—When reauthentication fails, the clients are disconnected. If the SSID is performing only MAC authentication and has a pre-authentication role assigned to the client, the client will get a post-authentication role only after a successful reauthentication. If reauthentication fails, the client retains the pre-authentication role. • On an SSID performing both L2 and L3 authentication (MAC with captive portal authentication)—When reauthentication succeeds, the client retains the role that is already assigned. If reauthentication fails, a pre-authentication role is assigned to the client. • On an SSID performing only L3 authentication (captive portal authentication)—When reauthentication succeeds, a pre-authentication role is assigned to the client that is in a post-authentication role. Due to this, the clients are required to go through captive portal to regain access. 	Enterprise , Personal, and Open security levels.

Table 22: Configuration Parameters for WLAN Security Settings in an Employee or Voice Network

Parameter	Description	Security Level Type
Blacklisting	To enable blacklisting of the clients with a specific number of authentication failures, select Enabled from the Blacklisting drop-down list and specify a value for Max authentication failures . The users who fail to authenticate the number of times specified in Max authentication failures field are dynamically blacklisted.	Enterprise , Personal , and Open security levels.
Accounting	Select any of the following options: <ul style="list-style-type: none"> To enable accounting, select Use authentication servers from the Accounting drop-down list. On enabling the accounting function, APs post accounting information to the RADIUS server at the specified Accounting interval. To use a separate server for accounting, select Use separate servers. The accounting server is distinguished from the authentication server specified for the SSID profile. To disable the accounting function, choose Disabled. 	Enterprise , Personal , and Open security levels.
Authentication survivability	To enable authentication survivability, set Authentication survivability to Enabled . Specify a value in hours for Cache timeout (global) to set the duration after which the authenticated credentials in the cache must expire. When the cache expires, the clients are required to authenticate again. You can specify a value within a range of 1 to 99 hours and the default value is 24 hours. NOTE: The authentication survivability feature requires ClearPass Policy Manager 6.0.2 or later, and is available only when the New server option is selected authentication. On setting this parameter to Enabled , AOS-W Instant authenticates the previously connected clients using EAP-PEAP authentication even when connectivity to ClearPass Policy Manager is temporarily lost. The Authentication survivability feature is not applicable when a RADIUS server is configured as an internal server.	Enterprise security level
MAC authentication	To enable MAC address based authentication for Personal and Open security levels, set MAC authentication to Enabled . For Enterprise security level, the following options are available: <ul style="list-style-type: none"> Perform MAC authentication before 802.1X—Select this checkbox to use 802.1X authentication only when the MAC authentication is successful. MAC authentication fail-thru—On selecting this checkbox, the 802.1X authentication is attempted when the MAC authentication fails. 	Enterprise , Personal , and Open security levels.
Delimiter character	Specify a character (for example, colon or dash) as a delimiter for the MAC address string. When configured, the OAW-IAP will use the delimiter in the MAC authentication request. For example, if you specify the colon as a delimiter, MAC addresses in the xx:xx:xx:xx:xx:xx format are used. If the delimiter is not specified, the MAC address in the xxxxxxxxxxxx format is used. NOTE: This option is available only when MAC authentication is enabled.	Enterprise , Personal , and Open security levels.

Table 22: Configuration Parameters for WLAN Security Settings in an Employee or Voice Network

Parameter	Description	Security Level Type
Uppercase support	Set to Enabled to allow the OAW-IAP to use uppercase letters in MAC address string for MAC authentication. NOTE: This option is available only if MAC authentication is enabled.	Enterprise , Personal , and Open security levels.
Upload Certificate	Click Upload Certificate and browse to upload a certificate file for the internal server. For more information on certificates, see Uploading Certificates on page 186 .	Enterprise , Personal , and Open security levels
Fast Roaming	You can configure the following fast roaming options for the WLAN SSID: <ul style="list-style-type: none"> • Opportunistic Key Caching: You can enable Opportunistic Key Caching (OKC) when WPA-2 Enterprise and Both (WPA2-WPA) encryption types are selected. If OKC is enabled, a cached pairwise master key (PMK) is used when the client roams to a new AP. This allows faster roaming of clients without the need for a complete 802.1X authentication. • 802.11r: Selecting this checkbox enables fast BSS transition. The Fast BSS Transition mechanism minimizes the delay when a client transitions from one BSS to another within the same cluster. This option is available only when WPA-2 enterprise and WPA2-personal encryption keys are selected. • 802.11k: Selecting this checkbox enables 802.11k roaming on the SSID profile. The 802.11k protocol enables OAW-IAPs and clients to dynamically measure the available radio resources. When 802.11k is enabled, OAW-IAPs and clients send neighbor reports, beacon reports, and link measurement reports to each other. • 802.11v: Selecting this checkbox enables 802.11v based BSS transition. 802.11v standard defines mechanisms for wireless network management enhancements and BSS transition management. It allows client devices to exchange information about the network topology and RF environment. The BSS transition management mechanism enables an AP to request a voice client to transition to a specific AP, or suggest a set of preferred APs to a voice client, due to network load balancing or BSS termination. It also helps the voice client identify the best AP to transition to as they roam. 	Enterprise , Personal , and Open security levels.

4. Click **Next** to configure access rules. For more information, see [Configuring Access Rules for a WLAN SSID Profile on page 105](#).

In the CLI

To configure enterprise security settings for the employee and voice users:

```
(Instant AP) (config)# wlan ssid-profile <name>
(Instant AP) (SSID Profile <name>)# opmode {wpa2-aes|wpa-tkip,wpa2-aes|dynamic-wep}
(Instant AP) (SSID Profile <name>)# leap-use-session-key
(Instant AP) (SSID Profile <name>)# termination
(Instant AP) (SSID Profile <name>)# auth-server <server-name>
(Instant AP) (SSID Profile <name>)# external-server
(Instant AP) (SSID Profile <name>)# server-load-balancing
(Instant AP) (SSID Profile <name>)# blacklist
```



```

(Instant AP) (SSID Profile <name>) # mac-authentication
(Instant AP) (SSID Profile <name>) # l2-auth-failthrough
(Instant AP) (SSID Profile <name>) # auth-survivability
(Instant AP) (SSID Profile <name>) # radius-accounting
(Instant AP) (SSID Profile <name>) # radius-accounting-mode {user-association| user-
authentication}
(Instant AP) (SSID Profile <name>) # radius-interim-accounting-interval <minutes>
(Instant AP) (SSID Profile <name>) # radius-reauth-interval <minutes>
(Instant AP) (SSID Profile <name>) # max-authentication-failures <number>
(Instant AP) (SSID Profile <name>) # no okc-disable
(Instant AP) (SSID Profile <name>) # dot11r
(Instant AP) (SSID Profile <name>) # dot11k
(Instant AP) (SSID Profile <name>) # dot11v
(Instant AP) (SSID Profile <name>) # exit
(Instant AP) (config) # auth-survivability cache-time-out
(Instant AP) (config) # end
(Instant AP) # commit apply

```

To configure personal security settings for the employee and voice users:

```

(Instant AP) (config) # wlan ssid-profile <name>
(Instant AP) (SSID Profile <name>) # opmode {wpa2-psk-aes|wpa-tkip| wpa-psk-tkip|wpa-psk-
tkip,wpa2-psk-aes| static-wep}
(Instant AP) (SSID Profile <name>) # mac-authentication
(Instant AP) (SSID Profile <name>) # auth-server <server-name>
(Instant AP) (SSID Profile <name>) # external-server
(Instant AP) (SSID Profile <name>) # server-load-balancing
(Instant AP) (SSID Profile <name>) # blacklist
(Instant AP) (SSID Profile <name>) # max-authentication-failures <number>
(Instant AP) (SSID Profile <name>) # radius-accounting
(Instant AP) (SSID Profile <name>) # radius-accounting-mode {user-association|user-
authentication}
(Instant AP) (SSID Profile <name>) # radius-interim-accounting-interval <minutes>
(Instant AP) (SSID Profile <name>) # radius-reauth-interval <minutes>
(Instant AP) (SSID Profile <name>) # end
(Instant AP) # commit apply

```

To configure open security settings for employee and voice users of a WLAN SSID profile:

```

(Instant AP) (config) # wlan ssid-profile <name>
(Instant AP) (SSID Profile <name>) # opmode opensystem
(Instant AP) (SSID Profile <name>) # mac-authentication
(Instant AP) (SSID Profile <name>) # auth-server <server-name>
(Instant AP) (SSID Profile <name>) # external-server
(Instant AP) (SSID Profile <name>) # server-load-balancing
(Instant AP) (SSID Profile <name>) # blacklist
(Instant AP) (SSID Profile <name>) # max-authentication-failures <number>
(Instant AP) (SSID Profile <name>) # radius-accounting
(Instant AP) (SSID Profile <name>) # radius-accounting-mode {user-association|user-
authentication}
(Instant AP) (SSID Profile <name>) # radius-interim-accounting-interval <minutes>
(Instant AP) (SSID Profile <name>) # radius-reauth-interval <minutes>
(Instant AP) (SSID Profile <name>) # end
(Instant AP) # commit apply

```

Configuring Access Rules for a WLAN SSID Profile

This section describes the procedure for configuring security settings for employee and voice network only. For information on guest network configuration, see [Captive Portal for Guest Access](#).



If you are creating a new SSID profile, complete the WLAN Settings and configure VLAN and security parameters, before defining access rules. For more information, see [Configuring WLAN Settings for an SSID](#)

You can configure up to 128 access rules for an employee, voice, or guest network using the AOS-W Instant UI or CLI.

In the AOS-W Instant UI

To configure access rules for an employee or voice network:

1. In the **Access Rules** tab, set slider to any of the following types of access control:
 - **Unrestricted**— Select this option to set unrestricted access to the network.
 - **Network-based**— Set the slider to **Network-based** to set common rules for all users in a network. The **Allow any to all destinations** access rule is enabled by default. This rule allows traffic to all destinations. To define an access rule:
 - a. Click **New**.
 - b. Select appropriate options in the **New Rule** window.
 - c. Click **OK**.
 - **Role-based**— Select this option to enable access based on user roles. For role-based access control:
 - Create a user role if required. For more information, see [Configuring User Roles](#).
 - Create access rules for a specific user role. For more information, see [Configuring ACL Rules for Network Services on page 189](#). You can also configure an access rule to enforce captive portal authentication for an SSID that is configured to use 802.1X authentication method. For more information, see [Configuring Captive Portal Roles for an SSID on page 145](#).
 - Create a role assignment rule. For more information, see [Configuring Derivation Rules on page 206](#).
2. Click **Finish**.

In the CLI

To configure access control rules for a WLAN SSID:

```
(Instant AP) (config)# wlan access-rule <name>
(Instant AP) (Access Rule <name>)# rule <dest> <mask> <match> {<protocol> <start-port> <end-
port> {permit|deny|src-nat|dst-nat{<IP-address> <port>| <port>}}| app <app> {permit| deny}|
appcategory <appgrp>| webcategory <webgrp> {permit| deny}| webreputation <webrep>
[<option1...option9>]
(Instant AP) (Access Rule <name>)# end
(Instant AP)# commit apply
```

To configure access control based on the SSID:

```
(Instant AP) (config)# wlan ssid-profile <name>
(Instant AP) (SSID Profile <name>)# set-role-by-ssid
(Instant AP) (SSID Profile <name>)# end
(Instant AP)# commit apply
```

To configure role assignment rules:

```
(Instant AP) (config)# wlan ssid-profile <name>
(Instant AP) (SSID Profile <name>)# set-role <attribute>{{equals|not-equals|starts-with|ends-
with|contains|matches-regular-expression}<operator><role>|value-of}
(Instant AP) (SSID Profile <name>)# end
(Instant AP)# commit apply
```

To configure a pre-authentication role:

```
(Instant AP) (config)# wlan ssid-profile <name>
(Instant AP) (SSID Profile <name>)# set-role-pre-auth <role>
```

```
(Instant AP) (SSID Profile <name>)# end
(Instant AP)# commit apply
```

To configure machine and user authentication roles

```
(Instant AP) (config)# wlan ssid-profile <name>
(Instant AP) (SSID Profile <name>)# set-role-machine-auth <machine_only> <user_only>
(Instant AP) (SSID Profile <name>)# end
(Instant AP)# commit apply
```

To configure unrestricted access:

```
(Instant AP) (config)# wlan ssid-profile <name>
(Instant AP) (SSID Profile <name>)# set-role-unrestricted
(Instant AP) (SSID Profile <name>)# end
(Instant AP)# commit apply
```

Example

The following example configures access rules for the wireless network:

```
(Instant AP) (config)# wlan access-rule WirelessRule
(Instant AP) (Access Rule "WirelessRule")# rule 192.0.2.2 255.255.255.0 match 6 4343 4343 log
classify-media
(Instant AP) (Access Rule "WirelessRule")# rule any any match app deny throttle-downstream 256
throttle-up 256
(Instant AP) (Access Rule "WirelessRule")# rule any any match appcategory collaboration permit
(Instant AP) (Access Rule "WirelessRule")# rule any any match webcategory gambling deny
(Instant AP) (Access Rule "WirelessRule")# rule any any match webcategory training-and-tools
permit
(Instant AP) (Access Rule "WirelessRule")# rule any any match webreputation well-known-sites
permit
(Instant AP) (Access Rule "WirelessRule")# rule any any match webreputation safe-sites permit
(Instant AP) (Access Rule "WirelessRule")# rule any any match webreputation benign-sites permit
(Instant AP) (Access Rule "WirelessRule")# rule any any match webreputation suspicious-sites
deny
(Instant AP) (Access Rule "WirelessRule")# rule any any match webreputation high-risk-sites
deny
(Instant AP) (Access Rule "WirelessRule")# end
(Instant AP)# commit apply
```

Configuring Per-AP SSID and Per-AP-VLAN Settings On a Wireless Profile

From 6.4.4.4-2.3.0 release onwards, you can set the environment variables, **per_ap_ssid** and **per_ap_vlan** on a **wlan ssid-profile** by using the CLI. The **ssid-profile-ssid** and **ssid-profile-vlan** fields must be enhanced to accept the **ssid** and **vlan** variables respectively.

You can configure the **per-ap-ssid** and the **per-ap-vlan** settings for the **SSID** and **VLAN** profiles respectively by using the AOS-W Instant CLI.

In the CLI

To configure the **wlan ssid-profile**:

```
(Instant AP) (config) # wlan ssid-profile <ssid_profile>
```

To configure the **per-ap-ssid** variable:

```
(Instant AP)# per-ap-ssid <text>
```

To configure the **per-ap-vlan** variable:

```
(Instant AP)# per-ap-vlan <vlan>
```

To verify the **per-ap-ssid** and **per-ap-vlan** configurations:

```
(Instant AP)# show ap-env
Antenna Type:Internal
name:TechPubsAP
```

```
per_ap_ssid:PCCW
per_ap_vlan:vlan
lACP_mode:enable
```



Refer to [Configuring a Wired Profile](#) section for information about configuring the **native-vlan** on a wired profile.

Configuring Fast Roaming for Wireless Clients

AOS-W Instant supports the following features that enable fast roaming of clients:

- [Opportunistic Key Caching](#)
- [Fast BSS Transition \(802.11r Roaming\)](#)
- [Radio Resource Management \(802.11k\)](#)
- [BSS Transition Management \(802.11v\)](#)

Opportunistic Key Caching

AOS-W Instant now supports opportunistic key caching (OKC) based roaming. In the OKC based roaming, the AP stores one pairwise master key (PMK) per client, which is derived from last 802.1X authentication completed by the client in the network. The cached PMK is used when a client roams to a new AP. This allows faster roaming of clients between the OAW-IAPs in a cluster, without requiring a complete 802.1X authentication.



OKC roaming (when configured in the 802.1X Authentication profile) is supported on WPA2 clients. If the wireless client (the 802.1X supplicant) does not support this feature, a complete 802.1X authentication is required whenever a client roams to a new AP.

Configuring an OAW-IAP for OKC Roaming

You can enable OKC roaming for WLAN SSID by using AOS-W Instant UI or CLI.

In the AOS-W Instant UI

1. Navigate to the WLAN wizard (click **Network>New** or **Network>** or select the WLAN SSID>**edit**).
2. Click the **Security** tab.
3. Slide to **Enterprise** security level. On selecting a security level, the authentication options applicable to Enterprise network are displayed.

4. Select the **WPA-2 Enterprise** or **Both (WPA-2 & WPA)** option from the **Key management** drop-down list. When any of these encryption types is selected, **Opportunistic Key Caching (OKC)** is enabled by default.
5. Click **Next** and then click **Finish**.

In the CLI

To disable OKC roaming on a WLAN SSID:

```
(Instant AP) (config)# wlan ssid-profile <name>
(Instant AP) (SSID Profile "<name>")# opmode {wpa2-aes|wpa-tkip,wpa-aes,wpa2-tkip,wpa2-aes}
(Instant AP) (SSID Profile "<name>")# okc-disable
(Instant AP) (config)# end
(Instant AP)# commit apply
```

To enable OKC roaming on a WLAN SSID:

```
(Instant AP) (config)# wlan ssid-profile <name>
(Instant AP) (SSID Profile "<name>")# opmode {wpa2-aes| wpa-tkip,wpa-aes,wpa2-tkip,wpa2-aes}
(Instant AP) (SSID Profile "<name>")# no okc-disable
(Instant AP) (config)# end
(Instant AP)# commit apply
```

Fast BSS Transition (802.11r Roaming)

802.11r is a roaming standard defined by IEEE. When enabled, 802.11r reduces roaming delay by pre-authenticating clients with multiple target APs before a client roams to an AP. With 802.11r implementation, clients pre-authenticate with multiple APs in a cluster.

As part of the 802.11r implementation, AOS-W Instant supports the Fast BSS Transition protocol. The Fast BSS Transition mechanism reduces client roaming delay when a client transitions from one BSS to another within the same cluster. This minimizes the time required to resume data connectivity when a BSS transition happens.



Fast BSS Transition is operational only if the wireless client supports 802.11r standard. If the client does not support 802.11r standard, it falls back to the normal WPA2 authentication method.

Configuring an OAW-IAP for 802.11r support

You can configure 802.11r support for a WLAN SSID by using the AOS-W Instant UI or CLI.

In the AOS-W Instant UI

1. Navigate to the WLAN wizard (click **Network**>**New** or **Network**> Select the WLAN SSID>**edit**).
2. Click the **Security** tab.
3. Under **Fast Roaming**, select the **802.11r** checkbox.
4. Click **Next** and then click **Finish**.

In the CLI

To enable 802.11r roaming on a WLAN SSID:

```
(Instant AP) (config)# wlan ssid-profile <name>
(Instant AP) (SSID Profile <name>)# dot11r
(Instant AP) (config)# end
(Instant AP)# commit apply
```

Example

```
(Instant AP) (config)# wlan ssid-profile dot11r-profile
(Instant AP) (SSID Profile "dot11r-profile")# dot11r
(Instant AP) (config)# end
(Instant AP)# commit apply
```

Radio Resource Management (802.11k)

The 802.11k protocol provides mechanisms for APs and clients to dynamically measure the available radio resources and enables stations to query and manage their radio resources. In an 802.11k enabled network, APs and clients can share radio and link measurement information, neighbor reports, and beacon reports with each other. This allows the WLAN network infrastructural elements and clients to assess resources and make optimal mobility decisions to ensure Quality of Service (QoS) and seamless continuity.

AOS-W Instant supports the following radio resource management information elements with 802.11k support enabled:

- *Power Constraint IE*—The power constraint element contains the information necessary to allow a client to determine the local maximum transmit power in the current channel.
- *AP Channel Report IE*—The AP channel report element contains a list of channels in a regulatory class where a client is likely to find an AP, including the AP transmitting the AP channel report.
- *RRM Enabled Capabilities IE*—The RRM Enabled Capabilities element signals support for radio measurements in a device. The clients use this IE to specify their radio measurement capabilities.
- *BSS Load Element*: The BSS Load element contains information on the density of clients and traffic levels in the QBSS.
- *Transmit Power Control (TPC) Report IE*: The TPC IE contains transmit power and link margin information.
- *Quiet IE*: The Quiet IE defines an interval during which no transmission occurs in the current channel. This interval may be used to assist in making channel measurements without interference from other stations in the BSS.
- *Extended Capabilities IE* - The extended capabilities IE carries information about the capabilities of an IEEE 802.11 station.

Beacon Report Requests and Probe Responses

The beacon request frame is sent by an AP to request a client to report the list of beacons heard by the client on all channels.

- The beacon request is sent using the radio measurement request action frame.
- It is sent only to those clients that have the capability to generate beacon reports. The clients indicate their capabilities through the *RRM enabled capabilities IE* sent in the association request frames.

- By default, the beacon request frames are sent at a periodicity of 60 seconds.

Configuring a WLAN SSID for 802.11k Support

You can enable 802.11k support on a WLAN SSID by using the AOS-W Instant UI or CLI.

In the AOS-W Instant UI

1. Navigate to the WLAN wizard (click **Network>New** or **Network>** Select the WLAN SSID>**edit**).
2. Click the **Security** tab.
3. Under **Fast Roaming**, Select the **802.11k** checkbox.
4. Click **Next** and then click **Finish**.



To allow the AP and clients to exchange neighbor reports, ensure that the Client match is enabled through **RF > ARM > Client match > Enabled** in the UI or by executing the **client-match** command in the **arm** configuration sub-mode.

In the CLI

To enable 802.11k profile:

```
(Instant AP) (config)# wlan ssid-profile <name>
(Instant AP) (SSID Profile <name>)# dot11k
(Instant AP) (config)# end
(Instant AP)# commit apply
```

To view the beacon report details:

```
show ap dot11k-beacon-report <mac>
```

To view the neighbor details:

```
show ap dot11k-nbrs
```

Example

```
(Instant AP) (config)# wlan ssid-profile dot11k-profile
(Instant AP) (SSID Profile "dot11k-profile")# dot11k
(Instant AP) (config)# end
(Instant AP)# commit apply
```

BSS Transition Management (802.11v)

The 802.11v standard provides Wireless Network Management enhancements to the IEEE 802.11 MAC and PHY. It extends radio measurements to define mechanisms for wireless network management of stations including BSS transition management.

OAW-IAPs support the generation of the BSS transition management request frames to the 802.11k clients when a suitable AP is identified for a client through client match.

Configuring a WLAN SSID for 802.11v Support

You can enable 802.11v support on a WLAN SSID by using the AOS-W Instant UI or CLI.

In the AOS-W Instant UI

1. Navigate to the WLAN wizard (click **Network>New** or **Network>** Select the WLAN SSID>**edit**).
2. Click the **Security** tab.
3. Under **Fast Roaming**, Select the **802.11v** checkbox.
4. Click **Next** and then click **Finish**.

In the CLI

To enable 802.11v profile:

```
(Instant AP) (config)# wlan ssid-profile <name>
(Instant AP) (SSID Profile <name>)# dot11v
(Instant AP) (config)# end
(Instant AP)# commit apply
```

Example

```
(Instant AP) (config)# wlan ssid-profile dot11v-profile
(Instant AP) (SSID Profile "dot11v-profile")# dot11v
(Instant AP) (config)# end
(Instant AP)# commit apply
```

Configuring Modulation Rates on a WLAN SSID

OAW-IAPs allow you to enable or disable modulation rates for a radio band, High Throughput (HT) Modulation and Coding Scheme (MCS) set, and Very High Throughput (VHT) MCS rates set when configuring a WLAN SSID profile. For example, the 802.11g band supports the modulation rate including 1, 2, 5, 6, 9, 11, 12, 18, 24, 36, 48, 54Mbps and 802.11a band supports a modulation rate set including 6, 9, 12, 18, 24, 36, 48, 54Mbps.

The 802.11 radio profiles support basic and transmission rates. The 802.11g basic modulation rates determine the 802.11b/g rates that are advertised in beacon frames and probe response and 802.11g transmission rates determine the 802.11b/g rates at which the AP can transmit data.

For 802.11n clients, you can now configure an HT MCS rate set so that the SSID does not broadcast the disabled MCS rates list.

For 802.11ac clients, only 10 MCS rates supported in the 802.11ac mode and OAW-IAPs use a combination of VHT MCSs and spatial streams to convey the supported MCS rates.

In the AOS-W Instant 6.4.3.4-4.2.1.0 release, the modulation rates can be configured only through the OAW-IAP CLI.

To configure modulation rates:

```
(host)# config terminal
(host) (config)# wlan ssid-profile <ssid_profile>
(host) (SSID Profile "<ssid_profile>")# a-basic-rates 6 9 12 18
(host) (SSID Profile "<ssid_profile>")# a-tx-rates 36 48 54
(host) (SSID Profile "<ssid_profile>")# supported-mcs-set 1,3,6,7
(host) (SSID Profile "<ssid_profile>")# vht-support-mcs-map 7, 9, 8
(host) (SSID Profile "<ssid_profile>")# end
(host)# commit apply
```

Multi-User-MIMO

The Multi-User Multiple-In Multiple-Output (MU-MIMO) feature allows the 802.11ac Wave 2 OAW-IAPs to send multiple frames to multiple clients simultaneously over the same frequency spectrum. With MU-MIMO, OAW-IAPs can support simultaneous directional Radio Frequency (RF) links and up to four simultaneous full-rate Wi-Fi connections (For example, smart phone, tablet, laptop, multimedia player or other client device).

The MU-MIMO feature is enabled by default on WLAN SSIDs to allow APs to use MU beamformer bit in beacon frames to broadcast to clients. When disabled, the MU beamformer bit is set to unsupported.

RTS/CTS Flow Control

The (Request to Send) RTS / (Clear to Send) CTS mechanism allows devices to reserve the RF medium and minimize the frame collisions introduced by hidden stations. When RTS is enabled, a higher number of retransmissions occurring on the WLAN trigger the RTS/CTS handshake and the transmitter station sends an RTS frame to the receiver station. The receiver station responds with a CTS frame. The RTS/CTS frames are sent only when the packet size exceeds the RTS threshold. By default, the RTS threshold is set to 2333 octets.

Enabling or Disabling MU-MIMO

The MU-MIMO feature is enabled by default on WLAN SSIDs. To disable this feature:

```
(host) (config) # wlan ssid-profile <ssid_profile>
(host) (SSID Profile "<ssid_profile>") # vht-mu-txbf-disable
(host) (SSID Profile "<ssid_profile>") # end
(host) # commit apply
```

To re-enable MU-MIMO:

```
(host) (config) # wlan ssid-profile <ssid_profile>
(host) (SSID Profile "<ssid_profile>") # no vht-mu-txbf-disable
(host) (SSID Profile "<ssid_profile>") # end
(host) # commit apply
```

Configuring RTS/CTS Threshold

You can set the RTS/CTS threshold value within the range of 0-2347 octets. By default, the RTS/CTS threshold is set to 2333.

To configure the RTS/CTS threshold:

```
(host) (config) # wlan ssid-profile <ssid_profile>
(host) (SSID Profile "<ssid_profile>") # rts-threshold <threshold>
(host) (SSID Profile "<ssid_profile>") # end
(host) # commit apply
```

To disable RTS/CTS, set the RTS threshold value to 0.

Disabling Short Preamble for Wireless Client

To improve network performance and communication between the AP and clients, you can enable or disable the transmission and reception of short preamble frames. If the short preamble is optional for the wireless devices connecting to an SSID, you can disable short preamble through the OAW-IAP CLI. Short preamble is enabled by default.

To disable short preamble:

```
(host) # config terminal
(host) (config) # wlan ssid-profile <ssid_profile>
(host) (SSID Profile "<ssid_profile>") # short-preamble-disable
(host) (SSID Profile "<ssid_profile>") # end
(host) # commit apply
```

Editing Status of a WLAN SSID Profile

You can enable or disable an SSID profile in the AOS-W Instant UI or CLI.

In the AOS-W Instant UI

To modify the status of a WLAN SSID profile:

1. In the **Networks** tab, select the network that you want to edit. The **edit** link is displayed.
2. Click the **edit** link. The **Edit network** window is displayed.

3. Select or clear the **Disable SSID** checkbox to disable or enable the SSID. The SSID is enabled by default.
4. Click **Next** or the tab name to move to the next tab.
5. Click **Finish** to save the modifications.

In the CLI

To disable an SSID

```
(Instant AP) (config)# wlan ssid-profile <name>
(Instant AP) (SSID Profile <name>)# disable
(Instant AP) (SSID Profile <name>)# end
(Instant AP)# commit apply
```

To enable an SSID:

```
(Instant AP) (config)# wlan ssid-profile <name>
(Instant AP) (SSID Profile <name>)# enable
(Instant AP) (SSID Profile <name>)# end
(Instant AP)# commit apply
```

Editing a WLAN SSID Profile

To edit a WLAN SSID profile:

1. In the **Networks** tab, select the network that you want to edit. The **edit** link is displayed.
2. Click the **edit** link. The **Edit network** window is displayed.
3. Modify the settings as required. Click **Next** to move to the next tab.
4. Click **Finish** to save the changes.

Deleting a WLAN SSID Profile

To delete a WLAN SSID profile:

1. In the **Networks** tab, click the network that you want to delete. A **x** link is displayed against the network to be deleted.
2. Click **x**. A delete confirmation window is displayed.
3. Click **Delete Now**.

This chapter describes the following procedures:

- [Configuring a Wired Profile on page 115](#)
- [Assigning a Profile to Ethernet Ports on page 120](#)
- [Editing a Wired Profile on page 120](#)
- [Deleting a Wired Profile on page 120](#)
- [Link Aggregation Control Protocol on page 121](#)
- [Understanding Hierarchical Deployment on page 122](#)

Configuring a Wired Profile

The Ethernet ports allow third-party devices such as VoIP phones or printers (which support only wired connections) to connect to the wireless network. You can also configure an Access Control List (ACL) for additional security on the Ethernet downlink.

The wired profile configuration for employee network involves the following procedures:

1. [Configuring Wired Settings on page 115](#)
2. [Configuring VLAN for a Wired Profile on page 116](#)
3. [Configuring Security Settings for a Wired Profile on page 117](#)
4. [Configuring Access Rules for a Wired Profile on page 118](#)

For information on creating a wired profile for guest network, see [Captive Portal for Guest Access](#)

Configuring Wired Settings

You can configure wired settings for a wired profile by using the AOS-W Instant UI or CLI.

In the AOS-W Instant UI

1. Click the **Wired** link under **More** at the top right corner of the AOS-W Instant main window. The **Wired** window is displayed.
2. Click **New** under **Wired Networks**. The **New Wired Network** window is displayed.
3. Click the **Wired Settings** tab and configure the following parameters:
 - a. **Name**—Specify a name for the profile.
 - b. **Primary Usage**—Select **Employee** or **Guest**.
 - c. **Speed/Duplex**—Ensure that appropriate values are selected for **Speed/Duplex**. Contact your network administrator if you need to assign speed and duplex parameters.
 - d. **POE**—Set **POE** to **Enabled** to enable Power over Ethernet.
 - e. **Admin Status**—Ensure that an appropriate value is selected. The **Admin Status** indicates if the port is up or down.
4. Click **Show advanced options** and configure the following parameters as required.
 - a. **Content Filtering**—To ensure that all DNS requests to non-corporate domains on this wired network are sent to OpenDNS, select **Enabled** for **Content Filtering**.
 - b. **Uplink**—Select **Enabled** to configure uplink on this wired profile. If **Uplink** is set to **Enabled** and this network profile is assigned to a specific port, the port will be enabled as Uplink port. For more

information on assigning a wired network profile to a port, see [Assigning a Profile to Ethernet Ports on page 120](#).

- c. **Spanning Tree**—Select the **Spanning Tree** checkbox to enable Spanning Tree Protocol (STP) on the wired profile. STP ensures that there are no loops in any bridged Ethernet network and operates on all downlink ports, regardless of forwarding mode. STP will not operate on the uplink port and is supported only on OAW-IAPs with three or more ports. By default Spanning Tree is disabled on wired profiles.
 - d. **Inactivity Timeout**—Specify the time out interval within the range of 60-86400 seconds for inactive wired clients. The default interval is 1000 seconds.
5. Click **Next**. The **VLAN** tab details are displayed.
 6. Configure VLAN for the wired profile. For more information, see [Configuring VLAN for a Wired Profile on page 116](#).

In the CLI

To configure wired settings for:

```
(Instant AP) (config)# wired-port-profile <name>
(Instant AP) (wired ap profile <name>)# type {<employee> |<guest>}
(Instant AP) (wired ap profile <name>)# speed {10 |100 |1000 |auto}
(Instant AP) (wired ap profile <name>)# duplex {half|full|auto}
(Instant AP) (wired ap profile <name>)# no shutdown
(Instant AP) (wired ap profile <name>)# poe
(Instant AP) (wired ap profile <name>)# uplink-enable
(Instant AP) (wired ap profile <name>)# content-filtering
(Instant AP) (wired ap profile <name>)# spanning-tree
(Instant AP) (wired ap profile <name>)# end
(Instant AP)# commit apply
```

Configuring VLAN for a Wired Profile



If you are creating a new wired profile, complete the Wired Settings procedure before configuring VLAN. For more information, see [Configuring Wired Settings on page 115](#).

You can configure VLAN using the AOS-W Instant UI or CLI.

In the AOS-W Instant UI

To configure VLAN:

1. In the **VLAN** tab, enter the following information.
 - a. **Mode**—You can specify any of the following modes:
 - **Access**—Select this mode to allow the port to carry a single VLAN specified as the native VLAN.
 - **Trunk**—Select this mode to allow the port to carry packets for multiple VLANs specified as allowed VLANs.
 - b. Specify any of the following values for **Client IP Assignment**:
 - **Virtual Controller Assigned**: Select this option to allow the Virtual Controller to assign IP addresses to the wired clients. When the Virtual Controller assignment is used, the source IP address is translated for all client traffic that goes through this interface. The Virtual Controller can also assign a guest VLAN to a wired client.
 - **Network Assigned**: Select this option to allow the clients to receive an IP address from the network to which the Virtual Controller is connected. On selecting this option, the **New** button to create a VLAN is displayed. Create a new VLAN if required.
 - c. If the **Trunk** mode is selected:

- Specify the **Allowed VLAN**, enter a list of comma separated digits or ranges 1,2,5 or 1-4, or all. The Allowed VLAN refers to the VLANs carried by the port in Access mode.
 - If the **Client IP Assignment** is set to **Network Assigned**, specify a value for **Native VLAN**. A VLAN that does not have a VLAN ID tag in the frames is referred to as Native VLAN. You can specify a value within the range of 1-4093.
- d. If the **Access** mode is selected:
- If the **Client IP Assignment** is set to **Virtual Controller Assigned**, proceed to step 2.
 - If the **Client IP Assignment** is set to **Network Assigned**, specify a value for **Access VLAN** to indicate the VLAN carried by the port in the **Access** mode.
2. Click **Next**. The **Security** tab details are displayed.
 3. Configure security settings for the wired profile. For more information, see [Configuring Security Settings for a Wired Profile on page 117](#).

In the CLI

To configure VLAN settings for a wired profile:

```
(Instant AP) (config)# wired-port-profile <name>
(Instant AP) (wired ap profile <name>)# switchport-mode {trunk|access}
(Instant AP) (wired ap profile <name>)# allowed-vlan <vlan>
(Instant AP) (wired ap profile <name>)# native-vlan {<guest|1...4095>}
(Instant AP) (wired ap profile <name>)# end
(Instant AP)# commit apply
```

To configure a new VLAN assignment rule:

```
(Instant AP) (config)# wired-port-profile <name>
(Instant AP) (wired ap profile <name>)# set-vlan <attribute>{equals| not-equals| starts-with|
ends-with| contains| matches-regular-expression} <operator> <VLAN-ID>| value-of}
(Instant AP) (wired ap profile <name>)# end
(Instant AP)# commit apply
```

Configuring Security Settings for a Wired Profile



If you are creating a new wired profile, complete the Wired Settings and VLAN procedures before specifying security settings. For more information, see [Configuring Wired Settings on page 115](#) and [Configuring VLAN Settings for a WLAN SSID Profile on page 95](#).

Configuring Security Settings for a Wired Employee Network

You can configure security parameters for an employee network by using the AOS-W Instant UI or CLI.

In the AOS-W Instant UI

To configure security parameters for an employee network:

1. Configure the following parameters in the **Security** tab.
 - **MAC authentication**—To enable MAC authentication, select **Enabled**. The MAC authentication is disabled by default.
 - **802.1X authentication**—To enable 802.1X authentication, select **Enabled**.
 - **MAC authentication fail-thru**—To enable authentication fail-thru, select **Enabled**. When this feature is enabled, 802.1X authentication is attempted when MAC authentication fails. The **MAC authentication fail-thru** checkbox is displayed only when both **MAC authentication** and **802.1X authentication** are **Enabled**.
 - Select any of the following options for **Authentication server 1**:

- **New**—On selecting this option, an external RADIUS server must be configured to authenticate the users. For information on configuring an external server, see [Configuring an External Server for Authentication on page 163](#).
 - **Internal server**— If an internal server is selected, add the clients that are required to authenticate with the internal RADIUS server. Click the **Users** link to add the users. For information on adding a user, see [Managing OAW-IAP Users on page 150](#).
 - **Accounting**—Select any of the following options:
 - **Disabled**—Disables accounting.
 - **Use authentication servers**—When selected, the authentication servers configured for the wired profile are used for accounting purposes.
 - **Use separate servers**—Allows you to configure separate accounting servers.
 - **Accounting interval**—Allows you set an accounting interval within the range of 0–60 minutes for sending interim accounting information to the RADIUS server.
 - **Reauth interval**—Specify the interval at which all associated and authenticated clients must be reauthenticated.
 - **Load balancing**— Set this to **Enabled** if you are using two RADIUS authentication servers, so that the load across the two RADIUS servers is balanced. For more information on the dynamic load balancing mechanism, see [Dynamic Load Balancing between Two Authentication Servers on page 163](#).
2. Click **Next**. The **Access** tab details are displayed.

In the CLI

To configure security settings for an employee network:

```
(Instant AP) (config)# wired-port-profile <name>
(Instant AP) (wired ap profile <name>)# mac-authentication
(Instant AP) (wired ap profile <name>)# l2-auth-failthrough
(Instant AP) (wired ap profile <name>)# auth-server <name>
(Instant AP) (wired ap profile <name>)# server-load-balancing
(Instant AP) (wired ap profile <name>)# radius-accounting
(Instant AP) (wired ap profile <name>)# radius-accounting-mode {user-association|user-
authentication}
(Instant AP) (wired ap profile <name>)# radius-interim-accounting-interval <minutes>
(Instant AP) (wired ap profile <name>)# radius-reauth-interval <Minutes>
(Instant AP) (wired ap profile <name>)# end
(Instant AP)# commit apply
```

Configuring Access Rules for a Wired Profile

The Ethernet ports allow third-party devices such as VoIP phones or printers (that support only wired connections) to connect to the wireless network. You can also configure an Access Control List (ACL) for additional security on the Ethernet downlink.



If you are creating a new wired profile, complete the Wired Settings and configure VLAN and security parameters, before defining access rules. For more information, see [Configuring Wired Settings on page 115](#), [Configuring VLAN for a Wired Profile on page 116](#), and [Configuring Security Settings for a Wired Profile on page 117](#).

You can configure access rules by using the AOS-W Instant UI or CLI.

In the AOS-W Instant UI

To configure access rules:

1. On the **Access** tab, configure the following access rule parameters.

- a. Select any of the following types of access control:
 - **Role-based**— Allows the users to obtain access based on the roles assigned to them.
 - **Unrestricted**— Allows the users to obtain unrestricted access on the port.
 - **Network-based**— Allows the users to be authenticated based on access rules specified for a network.
- b. If the **Role-based** access control is selected, perform the following steps:
 - Under **Roles**, select an existing role for which you want to apply the access rules, or click **New** and add the required role. The list of roles defined for all networks is displayed under **Roles**.



The default role with the same name as the network, is automatically defined for each network. The default roles cannot be modified or deleted.

- Select the access rule associated with a specific role and modify if required. To add a new access rule, click **New** in the **Access Rules** window. You can configure up to 64 access rules. For more information on configuring access rules, see [Configuring ACL Rules for Network Services on page 189](#).
- Configure rules to assign roles for an authenticated client. You can also configure rules to derive VLANs for the wired network profile. For more information on role assignment rules and VLAN derivation rules, see [Configuring Derivation Rules on page 206](#) and [Configuring VLAN Derivation Rules on page 211](#).
- Select the **Assign pre-authentication role** checkbox to add a pre-authentication role that allows some access to the users before the client authentication.
- Select the **Enforce Machine Authentication** checkbox, to configure access rights to clients based on whether the client device supports machine authentication. Select the **Machine auth only** and **User auth only** rules. Machine Authentication is only supported on Windows devices and devices such as iPads.



If **Enforce Machine Authentication** is enabled, both the device and the user must be authenticated for the role assignment rule to apply.

2. Click **Finish**.

In the CLI

To configure access rules for a wired profile:

```
(Instant AP) (config)# wired-port-profile <name>
(Instant AP) (wired ap profile <name>)# access-rule-name <name>
(Instant AP) (wired ap profile <name>)# end
(Instant AP)# commit apply
```

To configure role assignment rules:

```
(Instant AP) (config)# wired-port-profile <name>
(Instant AP) (wired ap profile <name>)# set-role <attribute>{{equals| not-equal| starts-with|
ends-with| contains| matches-regular-expression}<operator> <role>| value-of}
(Instant AP) (wired ap profile <name>)# end
(Instant AP)# commit apply
```

To configure a pre-authentication role:

```
(Instant AP) (config)# wired-port-profile <name>
(Instant AP) (wired ap profile <name>)# set-role-pre-auth <role>
(Instant AP) (wired ap profile <name>)# end
(Instant AP)# commit apply
```

To configure machine and user authentication roles:

```
(Instant AP) (config)# wired-port-profile <name>
```

```
(Instant AP) (wired ap profile <name>)# set-role-machine-auth <machine_only> <user-only>
(Instant AP) (wired ap profile <name>)# end
(Instant AP)# commit apply
```

To configure unrestricted access:

```
(Instant AP) (config)# wired-port-profile <name>
(Instant AP) (wired ap profile <name>)# set-role-unrestricted
(Instant AP) (wired ap profile <name>)# end
(Instant AP)# commit apply
```

Assigning a Profile to Ethernet Ports

You can assign profiles to Ethernet ports using the AOS-W Instant UI or CLI.

In the AOS-W Instant UI

To assign profiles to Ethernet ports:

1. Click the **Wired** link under **More** at the top right corner of the AOS-W Instant main window. The **Wired** window is displayed.
2. To assign an Ethernet downlink profile to Ethernet 0 port:
 - a. Ensure that the wired bridging on the port is enabled. For more information, see [Configuring Wired Bridging on Ethernet 0 for Mesh Point on page 340](#).
 - b. Select and assign a profile from the **0/0** drop down list.
 - c. To assign a wired profile to Ethernet 0/1 port, select the profile from the **0/1** drop down list.
 - d. If the OAW-IAP supports E2, E3 and E4 ports, assign profiles to other Ethernet ports by selecting a profile from the **0/2**, **0/3**, and **0/4** drop-down list.

In the CLI

To assign profiles to Ethernet ports:

```
(Instant AP) (config)# enet0-port-profile <name>
(Instant AP) (config)# enet1-port-profile <name>
(Instant AP) (config)# enet2-port-profile <name>
(Instant AP) (config)# enet3-port-profile <name>
(Instant AP) (config)# enet4-port-profile <name>
(Instant AP) (config)# end
(Instant AP)# commit apply
```

Editing a Wired Profile

To edit a wired profile:

1. Click the **Wired** link under **More** at the top right corner of the AOS-W Instant main window. The **Wired** window is displayed.
2. In the **Wired** window, select the wired profile to modify.
3. Click **Edit**. The **Edit Wired Network** window is displayed.
4. Modify the required settings.
5. Click **Finish** to save the modifications.

Deleting a Wired Profile

To delete a wired profile:

1. Click the **Wired** link under **More** at the top right corner of the AOS-W Instant main window. The **Wired** window is displayed.
2. In the **Wired** window, select the wired profile to delete.
3. Click **Delete**. The wired profile is deleted.

Link Aggregation Control Protocol

The OAW-IAP220 Series and OAW-IAP270 Series support the IEEE 802.11ac standard for high-performance WLAN. To support maximum traffic, port aggregation is required as it increases throughput and enhances reliability. To support port aggregation, AOS-W Instant supports Link Aggregation Control Protocol (LACP) based on the IEEE 802.3ad standard. 802.3ad standard for Ethernet aggregation uses LACP as a method to manage link configuration and balance traffic among aggregated ports.

LACP provides a standardized means for exchanging information with partner systems to form a dynamic link aggregation group. The LACP feature is automatically enabled during OAW-IAP boots and it dynamically detects the AP if connected to a partner system with LACP capability, by checking if there is any LACP Protocol Data Unit (PDU) received on either eth0 or eth1 port.

If the switch in the cluster has the LACP capability, you can combine eth0 and eth1 interfaces into the link aggregation group to form a single logical interface (port-channel). Port-channels can be used to provide additional bandwidth or link redundancy between two devices. OAW-IAP supports link aggregation using either standard port-channel (configuration based) or Link Aggregation Control Protocol (protocol signaling based). You can deploy OAW-IAP22x or OAW-IAP27x series access points with LACP configuration to benefit from the higher (greater than 1 Gbps) aggregate throughput capabilities of the two radios.



The LACP feature is supported only on OAW-IAP22x and OAW-IAP27x series access points

Verifying LACP Configuration on the OAW-IAP

There is no configuration required on the AP for enabling LACP support. However, you can view the status of LACP on OAW-IAPs by using the following command:

```
(Instant AP)# show lacp status
AP LACP Status
-----
Link Status   LACP Rate   Num Ports   Actor Key   Partner Key   Partner MAC
-----
Up            slow        2           17          1             70:81:05:11:3e:80
Slave Interface Status
-----
Slave I/f Name   Permanent MAC Addr   Link Status   Member of LAG   Link Fail Count
-----
eth0             6c:f3:7f:c6:76:6e    Up            Yes             0
eth1             6c:f3:7f:c6:76:6f    Up            Yes             0
Traffic Sent on Enet Ports
-----
Radio Num   Enet 0 Tx Count   Enet 1 Tx Count
-----
0           0                 0
1           0                 0
non-wifi   2                 17
```

Enabling Static LACP Configuration

When OAW-IAPs connect to switches which have the LACP capability, the LACP feature does not work as expected. To enable a static LACP configuration, new commands are introduced.

OAW-IAPs support the dynamic LACP configuration according to a peer switch. When the peer switch enables LACP configuration, the OAW-IAPs form the LACP. Users can enable, disable, and remove the static LACP configuration in the OAW-IAP. When the OAW-IAP boots up, it forms the LACP according to the static configuration.



The static LACP mode is supported on OAW-IAP225, OAW-IAP275, and IAP-325 series access points.

Verifying Static LACP Mode

To enable static LACP mode on OAW-IAPs, execute the following command in the OAW-IAP CLI:

```
(Instant AP)# lacp-mode enable
```

To verify the static LACP configuration, execute the following command in the OAW-IAP CLI:

```
(Instant AP)# show ap-env
Antenna Type:Internal
name:TechPubsAP
per_ap_ssid:1234
per_ap_vlan:abc
lacp_mode:enable
```

To disable static LACP mode on OAW-IAPs, execute the following command in the OAW-IAP CLI:

```
(Instant AP)# lacp-mode disable
```

To verify the static LACP configuration, execute the following command in the OAW-IAP CLI:

```
(Instant AP)# show ap-env
Antenna Type:Internal
name:TechPubsAP
per_ap_ssid:1234
per_ap_vlan:abc
lacp_mode:disable
```

Understanding Hierarchical Deployment

An OAW-IAP130 Series or OAW-RAP3WN (with more than one wired port) can be connected to the downlink wired port of another OAW-IAP (ethX). An OAW-IAP with a single Ethernet port (like OAW-IAP90 or OAW-IAP100 series devices) can be provisioned to use Ethernet bridging, so that Ethernet 0 port is converted to a downlink wired port.

You can also form an OAW-IAP network by connecting the downlink port of an AP to other APs. Only one AP in the network uses its downlink port to connect to the other APs. This AP (called the root AP) acts as the wired device for the network, provides DHCP service and an L3 connection to the ISP uplink with NAT. The root AP is always the master of the Instant network. In a single Ethernet port platform deployment, the root AP must be configured to use the 3G uplink.

A typical hierarchical deployment consists of the following:

- A direct wired ISP connection or a wireless uplink.
- One or more DHCP pools for private VLANs.
- One downlink port configured on a private VLAN without authentication for connecting to slave APs. Ensure that the downlink port configured in a private VLAN is not used for any wired client connection. Other downlink ports can be used for connecting to the wired clients.

The following figure illustrates a hierarchical deployment scenario:

Figure 31 Hierarchical Deployment

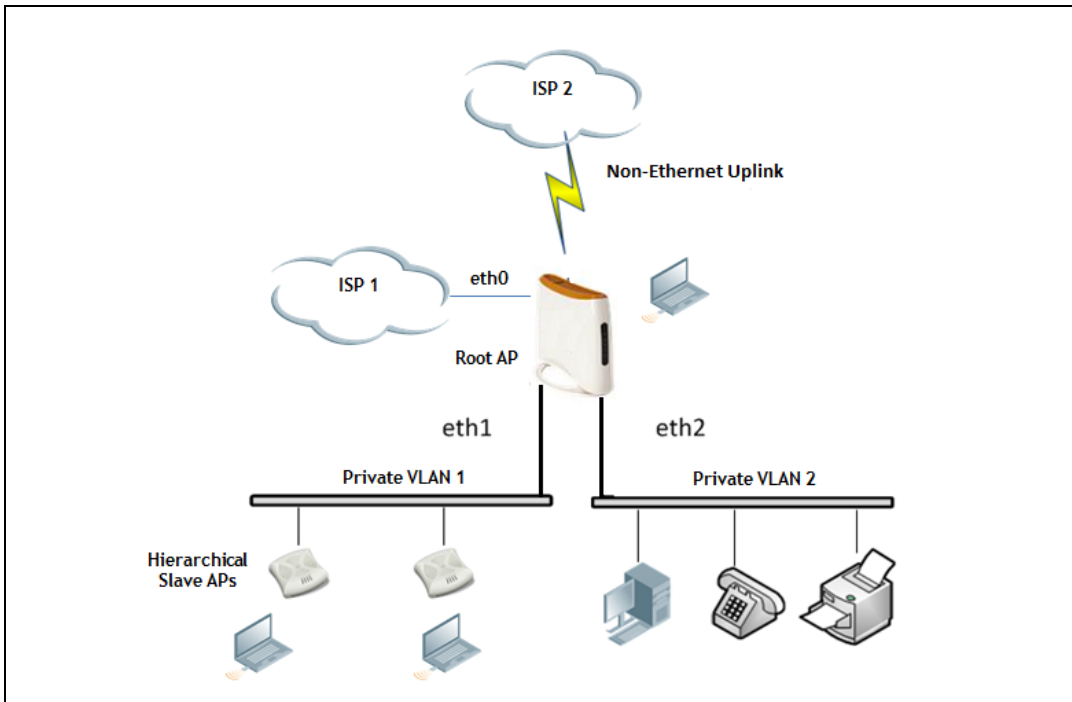

This chapter provides the following information:

- [Understanding Captive Portal on page 124](#)
- [Configuring a WLAN SSID for Guest Access on page 125](#)
- [Configuring Wired Profile for Guest Access on page 131](#)
- [Configuring Internal Captive Portal for Guest Network on page 133](#)
- [Configuring External Captive Portal for a Guest Network on page 136](#)
- [Configuring Facebook Login on page 142](#)
- [Configuring External Captive Portal Authentication Using ClearPass Guest on page 141](#)
- [Configuring Guest Logon Role and Access Rules for Guest Users on page 143](#)
- [Configuring Captive Portal Roles for an SSID on page 145](#)
- [Configuring Walled Garden Access on page 148](#)
- [Disabling Captive Portal Authentication on page 149](#)

Understanding Captive Portal

AOS-W Instant supports the captive portal authentication method, where a web page is presented to the guest users when they try to access the Internet from hotels, conference centers, or Wi-Fi hotspots. The web page also prompts the guest users to authenticate or accept the usage policy and terms. Captive portals are used at many Wi-Fi hotspots and can be used to control wired access as well.

The AOS-W Instant captive portal solution consists of the following:

- The captive portal web login page hosted by an internal or external server.
- The RADIUS authentication or user authentication against OAW-IAP's internal database.
- The SSID broadcast by the OAW-IAP.

Using AOS-W Instant, the administrators can create a wired or WLAN guest network based on captive portal authentication for guests, visitors, contractors, and any non-employee users who can use the enterprise Wi-Fi network. The administrators can also create guest accounts and customize the captive portal page with organization-specific logo, terms, and usage policy. With captive portal authentication and guest profiles, the devices that connect to the guest SSID are assigned IP addresses and an initial role. When a guest user tries to access a URL through HTTP or HTTPS, the captive portal web page prompting the user to authenticate with a user name and password is displayed.

Types of Captive Portal

AOS-W Instant supports the following types of captive portal authentication:

- **Internal captive portal**—For Internal captive portal authentication, an internal server is used for hosting the captive portal service. It supports the following types of authentication:
 - **Internal Authenticated**— When **Internal Authenticated** is enabled, a guest user must authenticate in the captive portal page to access the Internet. The guest users who are required to authenticate must already be added to the user database.
 - **Internal Acknowledged**— When **Internal Acknowledged** is enabled, a guest user must accept the terms and conditions to access the Internet.

- **External captive portal**— For external captive portal authentication, an external portal on the cloud or on a server outside the enterprise network is used.

Walled Garden

The administrators can also control the resources that the guest users can access and the amount of bandwidth or air time they can use at any given time. When an external captive portal is used, the administrators can configure a walled garden, which determines access to the URLs requested by the guest users. For example, a hotel environment where the unauthenticated users are allowed to navigate to a designated login page (for example, a hotel website) and all its contents. The users who do not sign up for the Internet service can view only the “allowed” websites (typically hotel property websites).

The administrators can allow or block access to specific URLs by creating a whitelist and blacklist. When the users attempt to navigate to other websites, which are not in the whitelist of the walled garden profile, the users are redirected to the login page. If the requested URL is on the blacklist, it is blocked. If it appears on neither list, the request is redirected to the external captive portal.

Configuring a WLAN SSID for Guest Access

You create an SSID for guest access by using the AOS-W Instant UI or CLI:

In the AOS-W Instant UI

1. On the **Networks** tab of the AOS-W Instant main window, click the **New** link. The **New WLAN** window is displayed.
2. Enter a name that uniquely identifies a wireless network in the **Name (SSID)** text box.
3. Select the **Guest** option for **Primary usage**.
4. Click the **Show advanced options** link. The advanced options for configuration are displayed.
5. Enter the required values for the following configuration parameters:

Table 23: WLAN Configuration Parameters

Parameter	Description
Broadcast filtering	<p>Select any of the following values:</p> <ul style="list-style-type: none"> • All—When set to All, the OAW-IAP drops all broadcast and multicast frames except DHCP and ARP, IGMP group queries, and IPv6 neighbor discovery protocols. • ARP—When set to ARP, the OAW-IAP drops all broadcast and multicast frames except DHCP and ARP, IGMP group queries, and IPv6 neighbor discovery protocols and additionally converts ARP requests to unicast and send frames directly to the associated client. • Disabled— When set to Disabled, all broadcast and multicast traffic is forwarded to the wireless interfaces.
Multicast transmission optimization	<p>Select Enabled if you want the OAW-IAP to select the optimal rate for sending broadcast and multicast frames based on the lowest of unicast rates across all associated clients. When this option is enabled, multicast traffic can be sent at up to 24 Mbps. The default rate for sending frames for 2.4 GHz is 1 Mbps and 5.0 GHz is 6 Mbps. This option is disabled by default.</p>
Dynamic multicast optimization	<p>Select Enabled to allow OAW-IAP to convert multicast streams into unicast streams over the wireless link. Enabling Dynamic Multicast Optimization (DMO) enhances the quality and reliability of streaming video, while preserving the bandwidth available to the non-video clients.</p> <p>NOTE: When you enable DMO on multicast SSID profiles, ensure that the DMO feature is enabled on all SSIDs configured in the same VLAN.</p>
DMO channel utilization threshold	<p>Specify a value to set a threshold for DMO channel utilization. With DMO, the OAW-IAP converts multicast streams into unicast streams as long as the channel utilization does not exceed this threshold. The default value is 90% and the maximum threshold value is 100%. When the threshold is reached or exceeds the maximum value, the OAW-IAP sends multicast traffic over the wireless link.</p>
Transmit Rates	<p>Specify the following parameters:</p> <ul style="list-style-type: none"> • 2.4 GHz—If the 2.4 GHz band is configured on the OAW-IAP, specify the minimum and maximum transmission rate. The default value for minimum transmission rate is 1 Mbps and maximum transmission rate is 54 Mbps. • 5 GHz—If the 5 GHz band is configured on the OAW-IAP, specify the minimum and maximum transmission rate. The default value for minimum transmission rate is 6 Mbps and maximum transmission rate is 54 Mbps.
Band	<p>Select a value to specify the band at which the network transmits radio signals. You can set the band to 2.4 GHz, 5 GHz, or All. The All option is selected by default.</p>
DTIM interval	<p>The DTIM interval indicates the delivery traffic indication message (DTIM) period in beacons, which can be configured for every WLAN SSID profile. The DTIM interval determines how often the OAW-IAP should deliver the buffered broadcast and multicast frames to associated clients in the powersave mode. The default value is 1, which means the client checks for buffered data on the OAW-IAP at every beacon. You can also configure a higher DTIM value for power saving.</p>

Table 23: WLAN Configuration Parameters

Parameter	Description
Min RSSI probe request	Sets a minimum Received signal strength indication (RSSI) threshold for probe requests.
Min RSSI auth request	Sets a minimum RSSI threshold for authentication requests.
Very high throughput	<p>Enables VHT function on OAW-IAP devices that support VHT. For 802.11ac OAW-IAPs, the VHT function is enabled by default. However, you can disable the VHT function if you want the 802.11ac OAW-IAPs to function as 802.11n OAW-IAPs.</p> <p>If VHT is configured or disabled on an SSID, the changes will apply only to the SSID on which it is enabled or disabled.</p>
Zone	<p>Specify the zone for the SSID. When the zone is defined in SSID profile and if the same zone is defined on an OAW-IAP, the SSID is created on that OAW-IAP. For more information on configuring zone details, see Configuring Zone Settings on an OAW-IAP on page 81.</p> <p>The following constraints apply to the zone configuration:</p> <ul style="list-style-type: none"> • An OAW-IAP can belong to only one zone and only one zone can be configured on an SSID. • If an SSID belongs to a zone, all OAW-IAPs in this zone can broadcast this SSID. If no OAW-IAP belongs to the zone configured on the SSID, the SSID is not broadcast. • If an SSID does not belong to any zone, all OAW-IAPs can broadcast this SSID.
Time Range	Click Edit , select a Time Range Profile from the list and specify if the profile must be enabled or disabled for the SSID, and then click OK .
Bandwidth Limits	<p>Under Bandwidth Limits:</p> <ul style="list-style-type: none"> • Airtime—Select this checkbox to specify an aggregate amount of airtime that all clients in this network can use for sending and receiving data. Specify the airtime percentage. • Each radio— Select this checkbox to specify an aggregate amount of throughput that each radio is allowed to provide for the connected clients. • Downstream and Upstream—Specify the downstream and upstream rates within a range of 1 to 65535 Kbps for the SSID users. If the assignment is specific for each user, select the Peruser checkbox.
Wi-Fi Multimedia (WMM) traffic management	<p>Configure the following options for WMM traffic management. WMM supports voice, video, best effort, and background access categories. To allocate bandwidth for the following types of traffic, specify a percentage value under Share. To configure DSCP mapping, specify a value under DSCP Mapping.</p> <ul style="list-style-type: none"> • Background WMM—For background traffic such as file downloads or print jobs. • Best effort WMM—For best effort traffic such as traffic from legacy devices or traffic from applications or devices that do not support QoS. • Video WMM—For video traffic generated from video streaming. • Voice WMM— For voice traffic generated from the incoming and outgoing voice communication.

Table 23: WLAN Configuration Parameters

Parameter	Description
	<p>For more information on WMM traffic and DSCP mapping, see Wi-Fi Multimedia Traffic Management on page 280</p> <p>For voice traffic and Spectralink Voice Prioritization, configure the following parameters:</p> <ul style="list-style-type: none"> • Traffic Specification (TSPEC)—To prioritize time-sensitive traffic such as voice traffic initiated by the client, select the Traffic Specification (TSPEC) check box. • TSPEC Bandwidth—To reserve bandwidth, set the TPSEC bandwidth to the desired value within the range of 200–600000 Kbps. The default value is 2000 Kbps. • Spectralink Voice Protocol (SVP)—Select the check box to prioritize voice traffic for SVP handsets.
Content filtering	Select Enabled to route all DNS requests for the non-corporate domains to OpenDNS on this network.
Inactivity timeout	Specify an interval for session timeout in seconds, minutes or hours. If a client session is inactive for the specified duration, the session expires and the users are required to log in again. You can specify a value within the range of 60-86400 seconds or up to 24 hours for a client session. The default value is 1000 seconds.
Deauth Inactive Clients	Select Enabled to allow the OAW-IAP to send a deauthentication frame to the inactive client and clear client entry.
SSID	Select the Hide checkbox if you do not want the SSID (network name) to be visible to users. Select the Disable checkbox if you want to disable the SSID. On selecting this, the SSID will be disabled, but will not be removed from the network. By default, all SSIDs are enabled.
Out of service (OOS)	<p>Enable or disable the SSID based on the following out of service states of the OAW-IAP:</p> <ul style="list-style-type: none"> • VPN down • Uplink down • Internet down • Primary uplink down <p>The network will be out of service when selected event occurs and the SSID is enabled or disabled as per the configuration settings applied. For example, if you select the VPN down option from the drop-down list and set the status to enabled, the SSID is enabled when the VPN connection is down and is disabled when the VPN connection is restored.</p>
OOS time (global)	Configure a hold time interval in seconds within a range of 30 to 300 seconds, after which the out-of-service operation is triggered. For example, if the VPN is down and the configured hold time is 45 seconds, the effect of this out-of-service state impacts the SSID availability after 45 seconds.
Max clients threshold	Specify the maximum number of clients that can be configured for each BSSID on a WLAN. You can specify a value within the range of 0 to 255. The default value is 64.

Table 23: WLAN Configuration Parameters

Parameter	Description
SSID Encoding	To encode the SSID, select UTF8. By default, the SSIDs are not encoded.
Deny inter user bridging	When enabled, the bridging traffic between two clients connected to the same SSID on the same VLAN is disabled. The clients can connect to the Internet, but cannot communicate with each other, and the bridging traffic between the clients is sent to the upstream device to make the forwarding decision.
ESSID	Enter the ESSID. If the value defined for ESSID value is not the same as profile name, the SSIDs can be searched based on the ESSID value and not by its profile name.

6. Click **Next** to configure VLAN settings. The VLAN tab contents are displayed.
7. Select any for the following options for **Client IP assignment**:
 - **Virtual Controller assigned**—On selecting this option, the client obtains the IP address from the Virtual Controller.
 - **Network assigned**—On selecting this option, the IP address is obtained from the network.
8. Based on the type client IP assignment mode selected, you can configure the VLAN assignment for clients as described in the following table:

Table 24: IP and VLAN Assignment for WLAN SSID Clients

Client IP Assignment	Client VLAN Assignment
Virtual Controller assigned	<p>If the Virtual Controller assigned is selected for client IP assignment, the Virtual Controller creates a private subnet and VLAN on the OAW-IAP for the wireless clients. The network address translation for all client traffic that goes out of this interface is carried out at the source. This setup eliminates the need for complex VLAN and IP address management for a multi-site wireless network.</p> <p>On selecting this option, the following client VLAN assignment options are displayed:</p> <ul style="list-style-type: none"> • Default: When selected, the default VLAN as determined by the Virtual Controller is assigned for clients. • Custom: When selected, you can specify a custom VLAN assignment option. You can select an existing DHCP scope for client IP and VLAN assignment or you can create a new DHCP scope by selecting New. For more information on DHCP scopes, see Configuring DHCP Scopes on page 215.
Network assigned	<p>If the Network assigned is selected, you can specify any of the following options for the Client VLAN assignment.</p> <ul style="list-style-type: none"> • Default— On selecting this option, the client obtains the IP address in the same subnet as the OAW-IAPs. By default, the client VLAN is assigned to the native VLAN on the wired network. • Static— On selecting this option, you need to specify a single VLAN, a comma separated list of VLANS, or a range of VLANs for all clients on this network. Select this option for configuring VLAN pooling. • Dynamic— On selecting this option, you can assign the VLANs dynamically from a Dynamic Host Configuration Protocol (DHCP) server. To create VLAN assignment rules, click New to assign the user to a VLAN. In the New VLAN Assignment Rule window, enter the following information: <ul style="list-style-type: none"> • Attribute— Select an attribute returned by the RADIUS server during authentication. • Operator— Select an operator for matching the string. • String— Enter the string to match • VLAN— Enter the VLAN to be assigned.

9. Click **Next** to configure [internal](#) or [external captive portal authentication, roles and access rules](#) for the guest users.



If the client IP assignment mode is set to **Network assigned** in a guest SSID profile, the guest clients can log out of the captive portal network by accessing the <https://securelogin.arubanetworks.com/auth/logout.html> URL.

In the CLI

To configure WLAN settings for an SSID profile:

```
(Instant AP) (config)# wlan ssid-profile <name>
(Instant AP) (SSID Profile <name>)# essid <ESSID-name>
(Instant AP) (SSID Profile <name>)# type <Guest>
(Instant AP) (SSID Profile <name>)# broadcast-filter <type>
(Instant AP) (SSID Profile <name>)# dtim-period <number-of-beacons>
(Instant AP) (SSID Profile <name>)# multicast-rate-optimization
(Instant AP) (SSID Profile <name>)# dynamic-multicast-optimization
(Instant AP) (SSID Profile <name>)# dmo-channel-utilization-threshold
```

```
(Instant AP) (SSID Profile <name>)# a-max-tx-rate <rate>
(Instant AP) (SSID Profile <name>)# a-min-tx-rate <rate>
(Instant AP) (SSID Profile <name>)# g-max-tx-rate <rate>
(Instant AP) (SSID Profile <name>)# g-min-tx-rate <rate>
(Instant AP) (SSID Profile <name>)# zone <zone>
(Instant AP) (SSID Profile <name>)# bandwidth-limit <limit>
(Instant AP) (SSID Profile <name>)# per-user-bandwidth-limit <limit>
(Instant AP) (SSID Profile <name>)# air-time-limit <limit>
(Instant AP) (SSID Profile <name>)# wmm-background-share <percentage-of-traffic_share>
(Instant AP) (SSID Profile <name>)# wmm-best-effort-share<percentage-of-traffic-share>
(Instant AP) (SSID Profile <name>)# wmm-video-share <percentage-of-traffic_share>
(Instant AP) (SSID Profile <name>)# wmm-voice-share <percentage-of-traffic_share>
(Instant AP) (SSID Profile <name>)# rf-band {<2.4>|<5.0>|<all>}
(Instant AP) (SSID Profile <name>)# content-filtering
(Instant AP) (SSID Profile <name>)# hide-ssid
(Instant AP) (SSID Profile <name>)# inactivity-timeout <interval>
(Instant AP) (SSID Profile <name>)# local-probe-req-thresh <threshold>
(Instant AP) (SSID Profile <name>)# max-clients-threshold <number-of-clients>
```

To manually assign VLANs for WLAN SSID users:

```
(Instant AP) (config)# wlan ssid-profile <name>
(Instant AP) (SSID Profile <name>)# vlan <vlan-ID>
```

To create a new VLAN assignment rule:

```
(Instant AP) (config)# wlan ssid-profile <name>
(Instant AP) (SSID Profile <name>)# set-vlan <attribute>{equals|not-equals| starts-with| ends-
with| contains|matches-regular-expression} <operator> <VLAN-ID>| value-of}
```

Configuring Wired Profile for Guest Access

You can configure wired settings for a wired profile by using the AOS-W Instant UI or CLI.

In the AOS-W Instant UI

1. Click the **Wired** link under **More** at the top right corner of the AOS-W Instant main window. The **Wired** window is displayed.
2. Click **New** under **Wired Networks**. The **New Wired Network** window is displayed.
3. Click the **Wired Settings** tab and enter the following information:
 - a. **Name**— Specify a name for the profile.
 - b. **Primary Usage**—Select **Employee** or **Guest**.
 - c. **Speed/Duplex**—Ensure that appropriate values are selected for **Speed/Duplex**. Contact your network administrator if you need to assign speed and duplex parameters.
 - d. **POE**—Set **POE** to **Enabled** to enable Power over Ethernet.
 - e. **Admin Status**—Ensure that an appropriate value is selected. The **Admin Status** indicates if the port is up or down.
 - f. **Content Filtering**— To ensure that all DNS requests to non-corporate domains on this wired network are sent to OpenDNS, select **Enabled** for **Content Filtering**.
 - g. **Uplink**—Select **Enabled** to configure uplink on this wired profile. If **Uplink** is set to **Enabled** and this network profile is assigned to a specific port, the port will be enabled as Uplink port. For more information on assigning a wired network profile to a port, see [Assigning a Profile to Ethernet Ports on page 120](#).
 - h. **Spanning Tree**—Select the **Spanning Tree** checkbox to enable Spanning Tree Protocol (STP) on the wired profile. STP ensures that there are no loops in any bridged Ethernet network and operates on all

downlink ports, regardless of forwarding mode. STP will not operate on the uplink port and is supported only on OAW-IAPs with three or more ports. By default Spanning Tree is disabled on wired profiles.

4. Click **Next**. The VLAN tab details are displayed.
5. Enter the following information.
 - a. **Mode**—You can specify any of the following modes:
 - **Access**—Select this mode to allow the port to carry a single VLAN specified as the native VLAN.
 - **Trunk**—Select this mode to allow the port to carry packets for multiple VLANs specified as allowed VLANs.
 - b. Specify any of the following values for **Client IP Assignment**:
 - **Virtual Controller Assigned**: Select this option to allow the Virtual Controller to assign IP addresses to the wired clients. When the Virtual Controller assignment is used, the source IP address is translated for all client traffic that goes through this interface. The Virtual Controller can also assign a guest VLAN to a wired client.
 - **Network Assigned**: Select this option to allow the clients to receive an IP address from the network to which the Virtual Controller is connected. On selecting this option, the **New** button to create a VLAN is displayed. Create a new VLAN if required.
 - c. If the **Trunk** mode is selected:
 - Specify the **Allowed VLAN**, enter a list of comma separated digits or ranges 1,2,5 or 1-4, or all. The Allowed VLAN refers to the VLANs carried by the port in Access mode.
 - If the **Client IP Assignment** is set to **Network Assigned**, specify a value for **Native VLAN**. A VLAN that does not have a VLAN ID tag in the frames is referred to as Native VLAN. You can specify a value within the range of 1-4093.
 - d. If the **Access** mode is selected:
 - If the **Client IP Assignment** is set to **Virtual Controller Assigned**, proceed to step 2.
 - If the **Client IP Assignment** is set to **Network Assigned**, specify a value for **Access VLAN** to indicate the VLAN carried by the port in the **Access** mode.
6. Click **Next** to configure [internal](#) or [external captive portal authentication, roles and access rules](#) for the guest users.

In the CLI

To configure wired settings for:

```
(Instant AP) (config)# wired-port-profile <name>
(Instant AP) (wired ap profile <name>)# type <guest>
(Instant AP) (wired ap profile <name>)# speed {10 |100 |1000 |auto}
(Instant AP) (wired ap profile <name>)# duplex {half|full|auto}
(Instant AP) (wired ap profile <name>)# no shutdown
(Instant AP) (wired ap profile <name>)# poe
(Instant AP) (wired ap profile <name>)# uplink-enable
(Instant AP) (wired ap profile <name>)# content-filtering
(Instant AP) (wired ap profile <name>)# spanning-tree
```

To configure VLAN settings for a wired profile:

```
(Instant AP) (config)# wired-port-profile <name>
(Instant AP) (wired ap profile <name>)# switchport-mode {trunk|access}
(Instant AP) (wired ap profile <name>)# allowed-vlan <vlan>
(Instant AP) (wired ap profile <name>)# native-vlan {<guest|1...4095>}
```

To configure a new VLAN assignment rule:

```
(Instant AP) (config)# wired-port-profile <name>
(Instant AP) (wired ap profile <name>)# set-vlan <attribute>{equals| not-equals| starts-with|
ends-with| contains| matches-regular-expression} <operator> <VLAN-ID>| value-of}
```

Configuring Internal Captive Portal for Guest Network

For internal captive portal authentication, an internal server is used for hosting the captive portal service. You can configure internal captive portal authentication when adding or editing a guest network created for wireless or wired profile through the AOS-W Instant UI or CLI.

In the AOS-W Instant UI

- Navigate to the WLAN wizard or Wired window.
 - To configure internal captive portal authentication for a WLAN SSID, in the **Network** tab, click **New** to create a new network profile or **edit** to modify an existing profile.
 - To configure internal captive portal authentication for a wired profile, click **More>Wired**. In the **Wired** window, click **New** under **Wired Networks** to create a new network, or click **Edit** to select an existing profile.
- Click the **Security** tab and assign values for the configuration parameters:

Table 25: Internal Captive Portal Configuration Parameters

Parameter	Description
Splash page type	Select any of the following from the drop-down list. <ul style="list-style-type: none"> Internal - Authenticated—When Internal Authenticated is enabled, the guest users are required to authenticate in the captive portal page to access the Internet. The guest users who are required to authenticate must already be added to the user database. Internal - Acknowledged— When Internal Acknowledged is enabled, the guest users are required to accept the terms and conditions to access the Internet.
MAC authentication	Select Enabled from the drop-down list to enable the MAC authentication.
Delimiter character	Specify a character (for example, colon or dash) as a delimiter for the MAC address string. When configured, the OAW-IAP will use the delimiter in the MAC authentication request. For example, if you specify the colon as a delimiter, MAC addresses in the xx:xx:xx:xx:xx:xx format are used. If the delimiter is not specified, the MAC address in the xxxxxxxxxxxx format is used. NOTE: This option is available only when MAC authentication is enabled.
Uppercase support	Set to Enabled to allow the OAW-IAP to use uppercase letters in MAC address string for MAC authentication. NOTE: This option is available only if MAC authentication is enabled.
WISPr (Applicable for WLAN SSIDs only.)	Select Enabled if you want to enable WISPr authentication. For more information on WISPr authentication, see Configuring WISPr Authentication on page 182 . NOTE: The WISPr authentication is applicable only for Internal-Authenticated splash pages and is not applicable for wired profiles.
Auth server 1 Auth server 2	Select any one of the following: <ul style="list-style-type: none"> A server from the list of servers if the server is already configured. Internal Server to authenticate user credentials at run time.

Parameter	Description
	<ul style="list-style-type: none"> • Select New for configuring a new external RADIUS or LDAP server for authentication.
Load balancing	Select Enabled to enable load balancing if two authentication servers are used.
Reauth interval	Select a value to allow the APs to periodically reauthenticate all associated and authenticated clients.
Blacklisting (Applicable for WLAN SSIDs only.)	If you are configuring a wireless network profile, select Enabled to enable blacklisting of the clients with a specific number of authentication failures.
Accounting mode (Applicable for WLAN SSIDs only.)	Select an accounting mode from Accounting mode for posting accounting information at the specified accounting interval. When the accounting mode is set to Authentication , the accounting starts only after client authentication is successful and stops when the client logs out of the network. If the accounting mode is set to Association , the accounting starts when the client associates to the network successfully and stops when the client is disconnected.

Parameter	Description
Accounting interval	Configure an accounting interval in minutes within the range of 0-60, to allow APs to periodically post accounting information to the RADIUS server.
Encryption (Applicable for WLAN SSIDs only.)	Select Enabled to configure encryption parameters. Select an encryption and configure passphrase.
Splash Page Design	<p>Under Splash Page Visuals, use the editor to specify text and colors for the initial page that will be displayed to the users when they connect to the network. The initial page asks for user credentials or email, depending on the splash page type (Internal - Authenticated or Internal -Acknowledged).</p> <p>To customize the splash page design, perform the following steps:</p> <ul style="list-style-type: none"> • To change the color of the splash page, click the Splash page rectangle and select the required color from the Background Color palette. • To change the welcome text, click the first square box in the splash page, type the required text in the Welcome text box, and click OK. Ensure that the welcome text does not exceed 127 characters. • To change the policy text, click the second square in the splash page, type the required text in the Policy text box, and click OK. Ensure that the policy text does not exceed 255 characters. • To upload a custom logo, click Upload your own custom logo image, browse the image file, and click upload image. Ensure that the image file size does not exceed 16 KB. • To redirect users to another URL, specify a URL in Redirect URL. • Click Preview to preview the captive portal page. <p>NOTE: You can customize the captive portal page using double-byte characters. Traditional Chinese, Simplified Chinese, and Korean are a few languages that use double-byte characters. Click on the banner, term, or policy in the Splash Page Visuals to modify the text in the red box. These fields accept double-byte characters or a combination of English and double-byte characters.</p>

3. Click **Next** to configure access rules.

In the CLI

To configure internal captive portal authentication:

```
(Instant AP) (config)# wlan ssid-profile <name>
(Instant AP) (SSID Profile <name>)# essid <ESSID-name>
(Instant AP) (SSID Profile <name>)# type <Guest>
(Instant AP) (SSID Profile <name>)# captive-portal <internal-authenticated> exclude-uplink
{3G|4G|Wifi|Ethernet}
(Instant AP) (SSID Profile <name>)# mac-authentication
(Instant AP) (SSID Profile <name>)# auth-server <server1>
(Instant AP) (SSID Profile <name>)# radius-reauth-interval <Minutes>
(Instant AP) (SSID Profile <name>)# end
(Instant AP)# commit apply
```

To configure internal captive portal for a wired profile:

```
(Instant AP) (config)# wired-port-profile <name>
(Instant AP) (wired ap profile <name>)# type <guest>
```

```
(Instant AP) (wired ap profile <name>)# captive-portal {<internal-authenticated>| <internal-acknowledged>} exclude-uplink {3G|4G|Wifi|Ethernet}
(Instant AP) (wired ap profile <name>)# mac-authentication
(Instant AP) (wired ap profile <name>)# auth-server <server1>
(Instant AP) (wired ap profile <name>)# radius-reauth-interval <Minutes>
(Instant AP) (wired ap profile <name>)# end
(Instant AP)# commit apply
```

To customize internal captive portal splash page:

```
(Instant AP) (config)# wlan captive-portal
(Instant AP) (Captive Portal)# authenticated
(Instant AP) (Captive Portal)# background-color <color-indicator>
(Instant AP) (Captive Portal)# banner-color <color-indicator>
(Instant AP) (Captive Portal)# banner-text <text>
(Instant AP) (Captive Portal)# decoded-texts <text>
(Instant AP) (Captive Portal)# redirect-url <url>
(Instant AP) (Captive Portal)# terms-of-use <text>
(Instant AP) (Captive Portal)# use-policy <text>
(Instant AP) (Captive Portal)# end
(Instant AP)# commit apply
```

To upload a customized logo from a TFTP server to the OAW-IAP:

```
(Instant AP)# copy config tftp <ip-address> <filename> portal logo
```

Configuring External Captive Portal for a Guest Network

This section provides the following information:

- [External Captive Portal Profiles on page 136](#)
- [Creating a Captive Portal Profile on page 136](#)
- [Configuring an SSID or Wired Profile to Use External Captive Portal Authentication on page 138](#)
- [External Captive Portal Redirect Parameters](#)

External Captive Portal Profiles

You can now configure external captive portal profiles and associate these profiles to a user role or SSID. You can create a set of captive portal profiles in the **Security>External Captive Portal** window and associate these profiles with an SSID or a wired profile. You can also create a new captive portal profile on the **Security** tab of the WLAN wizard or a Wired Network window. In the current release, you can configure up to sixteen external captive portal profiles.

When the captive portal profile is associated to an SSID, it is used before user authentication. If the profile is associated to a role, it is used only after the user authentication. When a captive portal profile is applied to an SSID or wired profile, the users connecting to the SSID or wired network are assigned a role with the captive portal rule. The guest user role allows only DNS and DHCP traffic between the client and network, and directs all HTTP or HTTPS requests to the captive portal unless explicitly permitted.

Creating a Captive Portal Profile

You can create a captive portal profile using the AOS-W Instant UI or CLI.

In the AOS-W Instant UI

1. Click **Security>External Captive Portal**.
2. Click **New**. The **New** pop-up window is displayed.
3. Specify values for the following parameters:

Table 26: Captive Portal Profile Configuration Parameters

Parameter	Description
Name	Enter a name for the profile.
Type	Select any one of the following types of authentication: <ul style="list-style-type: none"> ● Radius Authentication - Select this option to enable user authentication against a RADIUS server. ● Authentication Text - Select this option to specify an authentication text. The specified text will be returned by the external server after a successful user authentication.
IP or hostname	Enter the IP address or the hostname of the external splash page server.
URL	Enter the URL for the external captive portal server.
Port	Enter the port number.
Use https (Available only if RADIUS Authentication is selected)	Select Enabled to enforce clients to use HTTPS to communicate with the captive portal server.
Captive Portal failure	This field allows you to configure Internet access for the guest clients when the external captive portal server is not available. Select Deny Internet to prevent clients from using the network, or Allow Internet to allow the guest clients to access Internet when the external captive portal server is not available.
Automatic URL Whitelisting	Select Enabled to enable the automatic whitelisting of URLs. On selecting the check box for the external captive portal authentication, the URLs that are allowed for the unauthenticated users to access are automatically whitelisted. The automatic URL whitelisting is disabled by default.
Auth Text (Available only if Authentication Text is selected)	If the External Authentication splash page is selected, specify the authentication text to be returned by the external server after successful authentication.
Server Offload	Select Enabled to enable server offload. The server offload feature ensures that the non-browser client applications are not unnecessarily redirected to the external portal server and thereby reducing the load on the external captive portal server. The Server Offload option is Disabled by default.
Prevent frame overlay	When the Prevent frame overlay option is enabled, a frame can display a page only if it is in the same domain as the main page. This option is Enabled by default and can be used to prevent the overlay of frames.
Switch IP	Sends the IP address of the Virtual Controller in the redirection URL when external captive portal servers are used. This option is disabled by default.
Redirect URL	Specify a redirect URL if you want to redirect the users to another URL.

In the CLI

To configure an external captive portal profile:

```
(Instant AP) (config)# wlan external-captive-portal [profile_name]
(Instant AP) (External Captive Portal)# server <server>
(Instant AP) (External Captive Portal)# port <port>
(Instant AP) (External Captive Portal)# url <url>
(Instant AP) (External Captive Portal)# https
(Instant AP) (External Captive Portal)# redirect-url <url>
(Instant AP) (External Captive Portal)# server-fail-through
(Instant AP) (External Captive Portal)# no auto-whitelist-disable
(Instant AP) (External Captive Portal)# server-offload
(Instant AP) (External Captive Portal)# switch-ip
(Instant AP) (External Captive Portal)# prevent-frame-overlay
(Instant AP) (External Captive Portal)# end
(Instant AP)# commit apply
```

Configuring an SSID or Wired Profile to Use External Captive Portal Authentication

You can configure external captive portal authentication for a network profile when adding or editing a guest network using the AOS-W Instant UI or CLI.

In the AOS-W Instant UI

1. Navigate to the WLAN wizard or Wired window.
 - To configure external captive portal authentication for a WLAN SSID, in the **Network** tab, click **New** to create a new network profile or **edit** to modify an existing profile.
 - To configure external captive portal authentication for a wired profile, click **More>Wired**. In the **Wired** window, click **New** under **Wired Networks** to create a new network, or click **Edit** to select an existing profile.
2. On the **Security** tab, select **External** from the **Splash page type** drop-down list.
3. From the captive portal profile drop-down list, select a profile. You can select a default profile, or an already existing profile, or click **New** and [create a new profile](#).
4. Configure the following parameters based on the type of splash page you selected.

Table 27: External Captive Portal Configuration Parameters

Parameter	Description
Captive-portal proxy server	If required, configure a captive portal proxy server or a global proxy server to match your browser configuration by specifying the IP address and port number in the Captive-portal proxy server field.
WISPr	Select Enabled if you want to enable WISPr authentication. For more information on WISPr authentication, see Configuring WISPr Authentication on page 182 . NOTE: The WISPr authentication is applicable only for the External and Internal-Authenticated splash pages and is not applicable for wired profiles.
MAC authentication	Select Enabled if you want to enable MAC authentication. For information on MAC authentication, see Configuring MAC Authentication for a Network Profile on page 178 .

Table 27: External Captive Portal Configuration Parameters

Parameter	Description
Delimiter character	<p>Specify a character (for example, colon or dash) as a delimiter for the MAC address string. When configured, the OAW-IAP will use the delimiter in the MAC authentication request. For example, if you specify the colon as a delimiter, MAC addresses in the xx:xx:xx:xx:xx:xx format are used. If the delimiter is not specified, the MAC address in the xxxxxxxxxxxx format is used.</p> <p>NOTE: This option is available only when MAC authentication is enabled.</p>
Uppercase support	<p>Set to Enabled to allow the OAW-IAP to use uppercase letters in MAC address string for MAC authentication.</p> <p>NOTE: This option is available only if MAC authentication is enabled.</p>
Authentication server	<p>To configure an authentication server, select any of the following options:</p> <ul style="list-style-type: none">• If the server is already configured, select the server from the list.• To create new external RADIUS server, select New. For more information, see Configuring an External Server for Authentication on page 163.
Reauth interval	<p>Specify a value for the reauthentication interval at which the APs periodically reauthenticate all associated and authenticated clients.</p>
Accounting mode	<p>Select an accounting mode from Accounting mode for posting accounting information at the specified Accounting interval. When the accounting mode is set to Authentication, the accounting starts only after client authentication is successful and stops when the client logs out of the network. If the accounting mode is set to Association, the accounting starts when the client associates to the network successfully and stops when the client is disconnected.</p>
Accounting interval	<p>Configure an accounting interval in minutes within the range of 0–60, to allow APs to periodically post accounting information to the RADIUS server.</p>
Blacklisting	<p>If you are configuring a wireless network profile, select Enabled to enable blacklisting of the clients with a specific number of authentication failures.</p>
Max authentication failures	<p>If you are configuring a wireless network profile and the Blacklisting is enabled, specify a maximum number of authentication failures after which users who fail to authenticate must be dynamically blacklisted.</p>
Walled garden	<p>Click the link to open the Walled Garden window. The walled garden configuration determines access to the websites. For more information, see Configuring Walled Garden Access on page 148.</p>
Disable if uplink type is	<p>Select the type of the uplink to exclude.</p>
Encryption	<p>Select Enabled to configure encryption settings and specify the encryption parameters.</p>

5. Click **Next** to continue and then click **Finish** to apply the changes.

In the CLI

To configure security settings for guest users of the WLAN SSID profile:

```
(Instant AP) (config)# wlan ssid-profile <name>
(Instant AP) (SSID Profile <name>)# essid <ESSID-name>
(Instant AP) (SSID Profile <name>)# type <Guest>
(Instant AP) (SSID Profile <name>)# captive-portal{<type>[exclude-uplink <types>]| external
[exclude-uplink <types>] profile <name>[exclude-uplink <types>]]}
(Instant AP) (SSID Profile <name>)# captive-portal-proxy-server <IP> <port>
(Instant AP) (SSID Profile <name>)# blacklist
(Instant AP) (SSID Profile <name>)# mac-authentication
(Instant AP) (SSID Profile <name>)# max-authentication-failures <number>
(Instant AP) (SSID Profile <name>)# auth-server <server-name>
(Instant Access Point (SSID Profile <name>)# radius-accounting
(Instant Access Point (SSID Profile <name>)# radius-interim-accounting-interval
(Instant Access Point (SSID Profile <name>)# radius-accounting-mode {user-association|user-
authentication}
(Instant AP) (SSID Profile <name>)# wpa-passphrase <WPA_key>
(Instant AP) (SSID Profile <name>)# wep-key <WEP-key> <WEP-index>
(Instant AP) (SSID Profile <name>)# end
(Instant AP)# commit apply
```

To configure security settings for guest users of the wired profile:

```
(Instant AP) (config)# wired-port-profile <name>
(Instant AP) (wired ap profile <name>)# type <Guest>
(Instant AP) (wired ap profile <name>)# captive-portal{<type>[exclude-uplink <types>]| external
[exclude-uplink <types>] profile <name>[exclude-uplink <types>]]}
(Instant AP) (wired ap profile <name>)# mac-authentication
(Instant AP) (wired ap profile <name>)# end
(Instant AP)# commit apply
```

External Captive Portal Redirect Parameters

If the external captive portal redirection is enabled on a network profile, OAW-IAP sends an HTTP response with the redirect URL to display the splash page and enforce captive portal authentication by clients. The HTTP response from the OAW-IAP includes the following parameters:

Table 28: External Captive Portal Redirect Parameters

Parameters	Example Value	Description
cmd	login	Type of operation
mac	34:02:86:c6:d2:3e	Client MAC address
ssid	guest-ecp-109	ESSID
ip	192.0.2.0	Client IP address
apname	9c:1c:12:cb:a2:90	AP hostname
apmac	9c:1c:12:cb:a2:90	AP MAC address
vcname	instant-C8:1D:DA"	VC name
switchip	securelogin.arubanetworks.com	Captive portal domain used for external captive portal authentication

Parameters	Example Value	Description
url	http://www.google.com/	original URL

Configuring External Captive Portal Authentication Using ClearPass Guest

You can configure AOS-W Instant to point to ClearPass Guest as an external captive portal server. With this configuration, the user authentication is performed by matching a string in the server response and RADIUS server (either ClearPass Guest or a different RADIUS server).

Creating a Web Login page in ClearPass Guest

The ClearPass Guest Visitor Management Appliance provides a simple and personalized user interface through which operational staff can quickly and securely manage visitor network access. With ClearPass Guest, the users can have a controlled access to a dedicated visitor management user database. Through a customizable web portal, the administrators can easily create an account, reset a password or set an expiry time for visitors. Visitors can be registered at reception and provisioned with an individual guest account that defines their visitor profile and the duration of their visit. By defining a web login page on the ClearPass Guest Visitor Management Appliance, you are able to provide a customized graphical login page for visitors accessing the network.

For more information on setting up the RADIUS web login page, see the *RADIUS Services* section in the **ClearPass Guest Deployment Guide**.

Configuring RADIUS Server in AOS-W Instant UI

To configure AOS-W Instant to point to ClearPass Guest as an external captive portal server, perform the following steps:

1. Select the WLAN SSID for which you want to enable external captive portal authentication with ClearPass Policy Manager. You can also configure the RADIUS server when configuring a new SSID profile.
2. On the **Security** tab, select **External** from the Splash page type.
3. Select **New** from the **Captive portal profile** drop-down list and update the following fields:
 - a. Enter the IP address of the ClearPass Guest server in the **IP or hostname** field. Obtain the ClearPass Guest IP address from your system administrator.
 - b. Enter **/page_name.php** in the **URL** field. This URL must correspond to the **Page Name** configured in the ClearPass Guest RADIUS Web Login page. For example, if the Page Name is **Alcatel-Lucent**, the URL should be **/Alcatel-Lucent.php** in the AOS-W Instant UI.
 - c. Enter the **Port** number (generally should be **80**). The ClearPass Guest server uses this port for HTTP services.
 - d. Click **OK**.
4. To create an external RADIUS server, select **New** from the **Authentication server 1** drop-down list. For information on authentication server configuration parameters, see [Configuring an External Server for Authentication on page 163](#).
5. Click **Next** and then click **Finish**.
6. Click the updated SSID in the Network tab.
7. Open any browser and type any URL. AOS-W Instant redirects the URL to ClearPass Guest login page.
8. Log in to the network with the user name and password specified used while configuring the RADIUS server.

Configuring RADIUS Attribute for ClearPass Policy Manager Server Load Balancing

In AOS-W Instant 6.4.3.4-4.2.1.0, the administrators can configure a RADIUS server IP address as one of the parameters on ClearPass Policy Manager server for external captive portal user authentication. Configuring a RADIUS server attribute for guest user authentication allows the administrators to balance the load on the ClearPass Policy Manager servers.

When the RADIUS server IP address is configured under **Extra Fields** in the ClearPass Guest login page, the RADIUS server IP parameter is submitted to the server as part of the HTTP or HTTPS POST data when the guest users initiate an HTTP or HTTPS request. The AP intercepts this information to perform the actual RADIUS authentication with the server IP defined in the POST message. For more information on guest registration customization on ClearPass Guest, see *ClearPass Guest User Guide*.

Configuring Facebook Login

AOS-W Instant supports the Facebook Wi-Fi feature that allows the captive portal clients using a Facebook account to authenticate on an OAW-IAP. You can configure a guest network to use a customized Facebook page as an external captive portal URL and allow the OAW-IAP to redirect clients to a Facebook page when it receives an HTTP request. The users can select the appropriate option to authenticate and access the Internet. By configuring the Facebook login feature, businesses can pair their network with the Facebook Wi-Fi service, so that the users logging into Wi-Fi hotspots are presented with a business page, before gaining access to the network.

The Facebook Wi-Fi integration with the OAW-IAP includes the following procedures:

- [Setting up a Facebook Page](#)
- [Configuring an SSID](#)
- [Configuring the Facebook Portal Page](#)
- [Accessing the Portal Page](#)

Setting up a Facebook Page

To enable integration with the OAW-IAP, ensure that you have a Facebook page created as a local business with a valid location.

For information on:

- Creating a Facebook page, see the online help available at <https://www.facebook.com/help>
- Setting up and using Facebook Wi-Fi service, see <https://www.facebook.com/help/126760650808045>

Configuring an SSID

You can configure guest network profile and enable Facebook login through the AOS-W Instant UI or CLI.

In the AOS-W Instant UI

To enable Facebook login:

1. Navigate to **Networks>New** to create a new network profile.
2. Enter a name for the SSID.
3. Select **Guest** under **Primary usage**.
4. Configure other required parameters in the **WLAN Settings** and **VLAN** tabs.
5. On the **Security** tab, select **Facebook** from the **Splash page type** drop-down list.
6. Click **Next**. The **Access** tab contents are displayed.

- Click **OK**. The SSID with the Facebook option is created. After the SSID is created, OAW-IAP automatically registers with Facebook. If the OAW-IAP registration is successful, the **Facebook configuration** link is displayed in the **Security** tab of the WLAN wizard.

In the CLI

To configure an account for captive portal authentication:

```
(Instant AP) (config)# wlan ssid-profile <name>
(Instant AP) (SSID Profile <name>)# captive-portal {<type>[exclude-uplink <types>]|external
[exclude-uplink <types>]| profile <name>[exclude-uplink <types>]]}
(Instant AP) (SSID Profile <name>)# end
(Instant AP)# commit apply
```

Example

The following example configures a Facebook account for captive portal authentication:

```
(Instant AP) (config)# wlan ssid-profile guestNetwork
(Instant AP) (SSID Profile "guestNetwork")# captive-portal facebook
(Instant AP) (SSID Profile "guestNetwork")# end
(Instant AP)# commit apply
```

Configuring the Facebook Portal Page

To bind the Virtual Controller with the Facebook portal:

- Open the SSID with Facebook option enabled, navigate to the **Security** tab and click the **Facebook configuration** link. The Facebook page is displayed.



The **Facebook configuration** link is displayed only if the OAW-IAP is successfully registered with Facebook.

- Log in with your Facebook credentials. The **Facebook Wi-Fi Configuration** page is displayed.
- Select the Facebook page.
- Under **Bypass Mode**, select any of the following options:
 - Skip Check-in link**—When selected, the users are not presented with your business Facebook page, but are allowed to access the Internet by clicking the **Skip Check-in** link.
 - Require Wi-Fi code**—When selected, the users are assigned a Wi-Fi code to gain access to the Facebook page.
- Customize the session length and terms of service if required.
- Click **Save Settings**.

Accessing the Portal Page

To access the portal page:

- Connect to the SSID with Facebook option enabled.
- Launch a web browser. The browser opens the Facebook Wi-Fi page. If the Wi-Fi code based login is enabled, the users are prompted to enter the Wi-Fi code. If the **Skip Check-in** link is displayed, click the link to skip checking in to the Facebook business page and proceed to access the Internet.
- If you want to check in the business page, click **Check In** and provide your credentials. After checking in, click **Continue Browsing** to access the web page that was originally requested.

Configuring Guest Logon Role and Access Rules for Guest Users

For captive portal profile, you can create any the following types of roles:

- A pre-authenticated role - This role is assigned before the captive portal authentication. The user can only access certain destinations with this role.
- A guest role – This role is assigned after user authentication.
- A captive-portal role - This role can be assigned to any network such as employee, voice, or guest. When the user is assigned with this role, a splash page is displayed after opening a browser and the users may need to authenticate.

You can configure up to 128 access rules for guest user roles through the AOS-W Instant UI or CLI.

In the AOS-W Instant UI

To configure roles and access rules for the guest network:

1. On the **Access Rules** tab, set the slider to any of the following types of access control:
 - **Unrestricted**— Select this to set unrestricted access to the network.
 - **Network-based**— Set the slider to **Network-based** to set common rules for all users in a network. The **Allow any to all destinations** access rule is enabled by default. This rule allows traffic to all destinations. To define an access rule:
 - a. Click **New**.
 - b. Select appropriate options in the **New Rule** window.
 - c. Click **OK**.
 - **Role-based**— Select **Role-based** to enable access based on user roles. For role-based access control:
 - Create a user role if required. For more information, see [Configuring User Roles](#).
 - Create access rules for a specific user role. For more information, see [Configuring ACL Rules for Network Services on page 189](#). You can also configure an access rule to enforce captive portal authentication for an SSID with the 802.1X authentication method. For more information, see [Configuring Captive Portal Roles for an SSID on page 145](#).
 - Create a role assignment rule. For more information, see [Configuring Derivation Rules on page 206](#). AOS-W Instant supports role derivation based on the DHCP option for captive portal authentication. When the captive portal authentication is successful, a new user role is assigned to the guest users based on DHCP option configured for the SSID profile, instead of the pre-authenticated role.
2. Click **Finish**.

In the CLI

To configure access control rules for a WLAN SSID:

```
(Instant AP) (config)# wlan access-rule <name>
(Instant AP) (Access Rule <name>)# rule <dest> <mask> <match> {<protocol> <start-port> <end-
port> {permit|deny|src-nat|dst-nat{<IP-address> <port>| <port>}}| app <app> {permit| deny}|
appcategory <appgrp>| webcategory <webgrp> {permit| deny}| webreputation <webrep>
[<option1...option9>]
(Instant AP) (Access Rule <name>)# end
(Instant AP)# commit apply
```

To configure access control based on the SSID:

```
(Instant AP) (config)# wlan ssid-profile <name>
(Instant AP) (SSID Profile <name>)# set-role-by-ssid
(Instant AP) (SSID Profile <name>)# end
(Instant AP)# commit apply
```

To configure role assignment rules:

```
(Instant AP) (config)# wlan ssid-profile <name>
(Instant AP) (SSID Profile <name>)# set-role <attribute>{{equals|not-equals|starts-with|ends-
with|contains|matches-regular-expression}<operator><role>|value-of}
```



```
(Instant AP) (SSID Profile <name># end
(Instant AP) # commit apply
```

To configure a pre-authentication role:

```
(Instant AP) (config) # wlan ssid-profile <name>
(Instant AP) (SSID Profile <name># set-role-pre-auth <role>
(Instant AP) (SSID Profile <name># end
(Instant AP) # commit apply
```

To configure machine and user authentication roles

```
(Instant AP) (config) # wlan ssid-profile <name>
(Instant AP) (SSID Profile <name># set-role-machine-auth <machine_only> <user_only>
(Instant AP) (SSID Profile <name># end
(Instant AP) # commit apply
```

To configure unrestricted access:

```
(Instant AP) (config) # wlan ssid-profile <name>
(Instant AP) (SSID Profile <name># set-role-unrestricted
(Instant AP) (SSID Profile <name># end
(Instant AP) # commit apply
```

Example

The following example configures access rules for the wireless network:

```
(Instant AP) (config) # wlan access-rule WirelessRule
(Instant AP) (Access Rule "WirelessRule") # rule 192.0.2.2 255.255.255.0 match 6 4343 4343 log
classify-media
(Instant AP) (Access Rule "WirelessRule") # rule any any match app deny throttle-downstream 256
throttle-up 256
(Instant AP) (Access Rule "WirelessRule") # rule any any match appcategory collaboration permit
(Instant AP) (Access Rule "WirelessRule") # rule any any match webcategory gambling deny
(Instant AP) (Access Rule "WirelessRule") # rule any any match webcategory training-and-tools
permit
(Instant AP) (Access Rule "WirelessRule") # rule any any match webreputation well-known-sites
permit
(Instant AP) (Access Rule "WirelessRule") # rule any any match webreputation safe-sites permit
(Instant AP) (Access Rule "WirelessRule") # rule any any match webreputation benign-sites permit
(Instant AP) (Access Rule "WirelessRule") # rule any any match webreputation suspicious-sites
deny
(Instant AP) (Access Rule "WirelessRule") # rule any any match webreputation high-risk-sites
deny
(Instant AP) (Access Rule "WirelessRule") # end
(Instant AP) # commit apply
```

Configuring Captive Portal Roles for an SSID

You can configure an access rule to enforce captive portal authentication for SSIDs that use 802.1X authentication to authenticate clients. You can configure rules to provide access to external or internal captive portal, so that some of the clients using this SSID can derive the captive portal role.

The following conditions apply to the 802.1X and captive portal authentication configuration:

- If a user role does not have captive portal settings configured, the captive portal settings configured for an SSID are applied to the client's profile.
- If the SSID does not have captive portal settings configured, the captive portal settings configured for a user role are applied to the client's profile.
- If captive portal settings are configured for both SSID and user role, the captive portal settings configured for a user role are applied to the client's profile.

You can create a captive portal role for both **Internal-acknowledged** and **External Authentication Text** splash page types.

To enforce the captive portal role, use the AOS-W Instant UI or CLI.

In the AOS-W Instant UI

To create a captive portal role:

1. Select an SSID profile from the **Networks** tab. The **Edit <WLAN-Profile>** window is displayed.
2. On the **Access** tab, slide to **Role-based** access control by using the scroll bar.
3. Select a role or create a new one if required.
4. Click **New** to add a new rule. The **New Rule** window is displayed.
5. In the **New Rule** window, specify the following parameters. The following figures show the parameters for captive portal role configuration:

Figure 32 Captive Portal Rule for Internal Acknowledged Splash Page

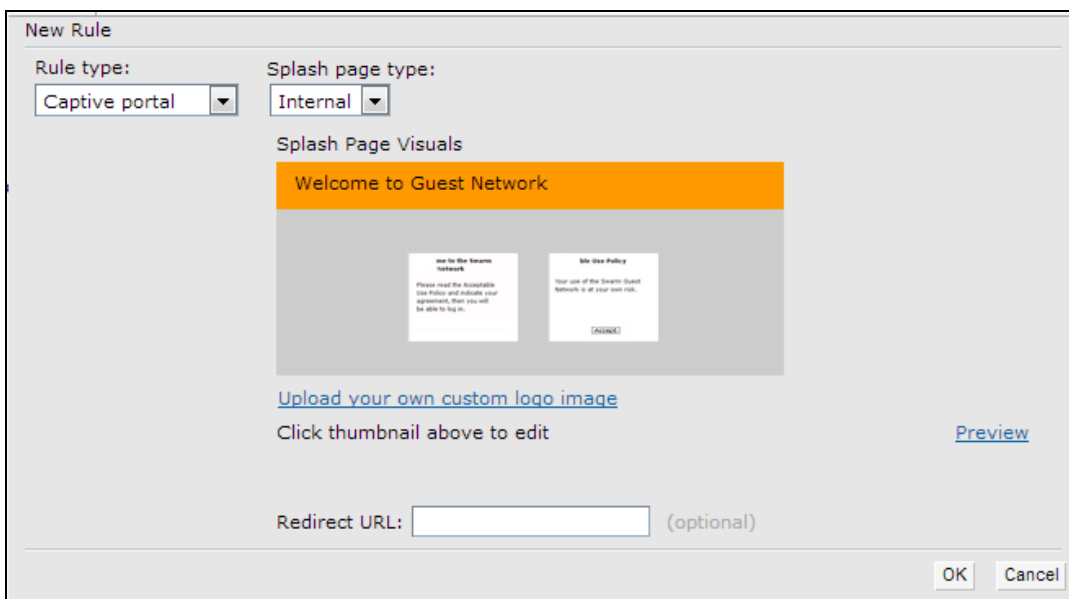

The screenshot shows the 'New Rule' configuration window. It has two dropdown menus at the top: 'Rule type:' set to 'Captive portal' and 'Splash page type:' set to 'Internal'. Below these is a preview of the splash page titled 'Welcome to Guest Network'. The preview shows a blue header, a main content area with two columns of text and a 'LOGOUT' button, and a footer with a 'Preview' link. Below the preview is a text input field for 'Redirect URL:' with '(optional)' next to it. At the bottom right are 'OK' and 'Cancel' buttons.

Figure 33 Captive Portal Rule for External Captive Portal profile

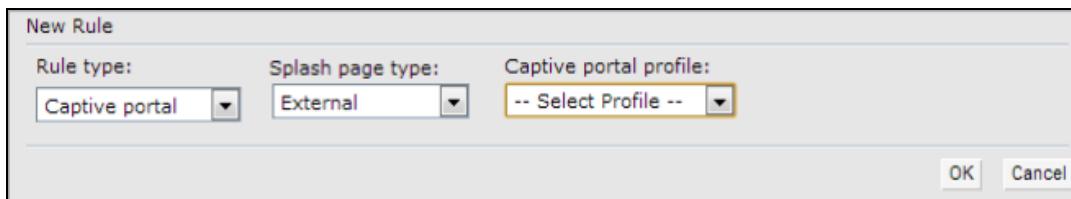

The screenshot shows the 'New Rule' configuration window. It has three dropdown menus at the top: 'Rule type:' set to 'Captive portal', 'Splash page type:' set to 'External', and 'Captive portal profile:' set to '-- Select Profile --'. At the bottom right are 'OK' and 'Cancel' buttons.

Table 29: *Captive Portal Rule Configuration Parameters*

Field	Description
Rule type	Select Captive Portal from the drop-down list.
Splash Page Type	Select any of the following attributes: <ul style="list-style-type: none">• Select Internal to configure a rule for internal captive portal authentication.• Select External to configure a rule for external captive portal authentication.
Internal	If Internal is selected as splash page type, perform the following steps: <ul style="list-style-type: none">• Under Splash Page Visuals, use the editor to specify text and colors for the initial page that would be displayed to users connecting to the network. The initial page asks for user credentials or email, depending on the splash page type configured• To change the color of the splash page, click the Splash page rectangle and select the required color from the Background Color palette.• To change the welcome text, click the first square box in the splash page, type the required text in the Welcome text box, and then click OK. Ensure that the welcome text does not exceed 127 characters.• To change the policy text, click the second square in the splash page, type the required text in the Policy text box, and click OK. Ensure that the policy text does not exceed 255 characters.• Specify the URL to which you want to redirect the guest users.• To upload a custom logo, click Upload your own custom logo image, browse the image file, and click upload image.• To preview the captive portal page, click Preview.
External	If External is selected, perform the following steps: <ul style="list-style-type: none">• Select a profile from the Captive portal profile drop-down list.• If you want to edit the profile, click Edit and update the following parameters:<ul style="list-style-type: none">• Type—Select either Radius Authentication (to enable user authentication against a RADIUS server) or Authentication Text (to specify the authentication text to be returned by the external server after a successful user authentication).• IP or hostname— Enter the IP address or the host name of the external splash page server.• URL— Enter the URL for the external splash page server.• Port—Enter the port number.• Redirect URL—Specify a redirect URL if you want to redirect the users to another URL.• Captive Portal failure—This field allows you to configure Internet access for the guest clients when the external captive portal server is not available. Select Deny Internet to prevent clients from using the network, or Allow Internet to allow the guest clients to access Internet when the external captive portal server is not available.

Field	Description
	<ul style="list-style-type: none"> • Automatic URL Whitelisting— Select Enabled or Disabled to enable or disable automatic whitelisting of URLs. On selecting the checkbox for the external captive portal authentication, the URLs allowed for the unauthenticated users to access are automatically whitelisted. The automatic URL whitelisting is disabled by default. • Auth Text—Indicates the authentication text returned by the external server after a successful user authentication.

6. Click **OK**. The enforce captive portal rule is created and listed as an access rule.
7. Create a role assignment rule based on the user role, to which the captive portal access rule is assigned.
8. Click **Finish**.

The client can connect to this SSID after authenticating with username and password. After a successful user login, the captive portal role is assigned to the client.

In the CLI

To create a captive portal role:

```
(Instant AP) (config)# wlan access-rule <Name>
(Instant AP) (Access Rule <Name>)# captive-portal {external [profile <name>]|internal}
(Instant AP) (Access Rule <Name>)# end
(Instant AP)# commit apply
```

Configuring Walled Garden Access

On the Internet, a walled garden typically controls access to web content and services. The Walled garden access is required when an external captive portal is used. For example, a hotel environment where the unauthenticated users are allowed to navigate to a designated login page (for example, a hotel website) and all its contents.

The users who do not sign up for the Internet service can view the allowed websites (typically hotel property websites). The website names must be DNS-based and support the option to define wildcards. When a user attempts to navigate to other websites that are not in the whitelist of the walled garden profile, the user is redirected to the login page. OAW-IAP supports Walled Garden only for the HTTP requests. For example, if you add yahoo.com in Walled Garden whitelist and the client sends an HTTPS request (https://yahoo.com), the requested page is not displayed and the users are redirected to the captive portal login page.

In addition, a blacklisted walled garden profile can also be configured to explicitly block the unauthenticated users from accessing some websites.

You can create a walled garden access in AOS-W Instant UI or CLI.

In the AOS-W Instant UI

To create a Walled Garden access:

1. Click the **Security** link at the top right corner of the AOS-W Instant main window. The **Security** window is displayed.
2. Click **Walled Garden**. The **Walled Garden** tab contents are displayed.
3. To allow the users to access a specific domain, click **New** and enter the domain name or URL in the **Whitelist** section of the window. This allows access to a domain while the user remains unauthenticated. Specify a POSIX regular expression (regex(7)). For example:

- yahoo.com matches various domains such as news.yahoo.com, travel.yahoo.com and finance.yahoo.com
 - www.apple.com/library/test is a subset of www.apple.com site corresponding to path /library/test/*
 - favicon.ico allows access to /favicon.ico from all domains.
4. To deny users access to a domain, click **New** and enter the domain name or URL in the **Blacklist** section of the window. This prevents the unauthenticated users from viewing specific websites. When a URL specified in the blacklist is accessed by an unauthenticated user, OAW-IAP sends an HTTP 403 response to the client with an error message.
If the requested URL does not appear on the blacklist or whitelist, the request is redirected to the external captive portal.
 5. To modify the list, select the domain name/URL and click **Edit** . To remove an entry from the list, select the URL from the list and click **Delete**.
 6. Click **OK** to apply the changes.

In the CLI

To create a Walled Garden access:

```
(Instant AP) (config)# wlan walled-garden
(Instant AP) (Walled Garden)# white-list <domain>
(Instant AP) (Walled Garden)# black-list <domain>
(Instant AP) (Walled Garden)# end
(Instant AP)# commit apply
```

Disabling Captive Portal Authentication

To disable captive portal authentication, perform the following steps:

1. Select a wireless or wired profile. Depending on the network profile selected, the **Edit <WLAN-Profile>** or **Edit Wired Network** window is displayed.



You can also customize splash page design on the **Security** tab of **New WLAN** (WLAN wizard) and **New Wired Network** (wired profile window) when configuring a new profile.

2. Navigate to the **Security** tab.
3. Select **None** from the **Splash page type** drop-down list. Although the splash page is disabled, you can enable MAC authentication, configure authentication servers, set accounting parameters, blacklist clients based on MAC authentication failures, and configure encryption keys for authorized access.
4. If required, configure the security parameters.
5. Click **Next** and then click **Finish** to apply the changes.

This chapter provides the following information:

- [Managing OAW-IAP Users on page 150](#)
- [Supported Authentication Methods on page 155](#)
- [Supported Authentication Servers on page 158](#)
- [Understanding Encryption Types on page 172](#)
- [Configuring Authentication Survivability on page 173](#)
- [Configuring Authentication Servers on page 158](#)
- [Configuring 802.1X Authentication for a Network Profile on page 174](#)
- [Enabling 802.1X Supplicant Support on page 176](#)
- [Configuring MAC Authentication for a Network Profile on page 178](#)
- [Configuring MAC Authentication with 802.1X Authentication on page 180](#)
- [Configuring MAC Authentication with Captive Portal Authentication on page 181](#)
- [Configuring WISPr Authentication on page 182](#)
- [Blacklisting Clients on page 183](#)
- [Uploading Certificates on page 186](#)

Managing OAW-IAP Users

The OAW-IAP users can be classified as follows:

- **Administrator**— An admin user who creates SSIDs, wired profiles, DHCP server configuration parameters, and manages the local user database. The admin users can access to the Virtual Controller Management User Interface.
- **Guest administrator**— A guest interface management user who manages guest users added in the local user database.
- **Administrator with read-only access**— The read-only admin user does not have access to the AOS-W Instant CLI. The AOS-W Instant UI will be displayed in the read-only mode for these users.
- **Employee users**—Employees who use the enterprise network for official tasks.
- **Guest users**—Visiting users who temporarily use the enterprise network to access the Internet.

The user access privileges are determined by OAW-IAP management settings in the OmniVista Management client, and the type of the user. The following table outlines the access privileges defined for the admin user, guest management interface admin, and read-only users.

Table 30: User Privileges

User Category	OmniVista in Management Mode	OAW-IAP in Monitor mode or without OmniVista
administrator	Access to local user database only	Complete access to the OAW-IAP
read-only administrator	No write privileges	No write privileges
guest administrator	Access to local user database only	Access to local user database only

Configuring OAW-IAP Users

The AOS-W Instant user database consists of a list of guest and employee users. The addition of a user involves specifying a login credentials for a user. The login credentials for these users are provided outside the AOS-W Instant system.

A guest user can be a visitor who is temporarily using the enterprise network to access the Internet. However, if you do not want to allow access to the internal network and the Intranet, you can segregate the guest traffic from the enterprise traffic by creating a guest WLAN and specifying the required authentication, encryption, and access rules.

An employee user is the employee who is using the enterprise network for official tasks. You can create Employee WLANs, specify the required authentication, encryption and access rules and allow the employees to use the enterprise network.



The user database is also used when an OAW-IAP is configured as an internal RADIUS server.

The local user database of APs can support up to 512 user entries.

In the AOS-W Instant UI

To configure users:

1. Click the **Security** at the top right corner of AOS-W Instant main window.
2. Click **Users for Internal Server**. The following figure shows the contents of the **Users for Internal Server** tab.

Figure 34 Adding a User

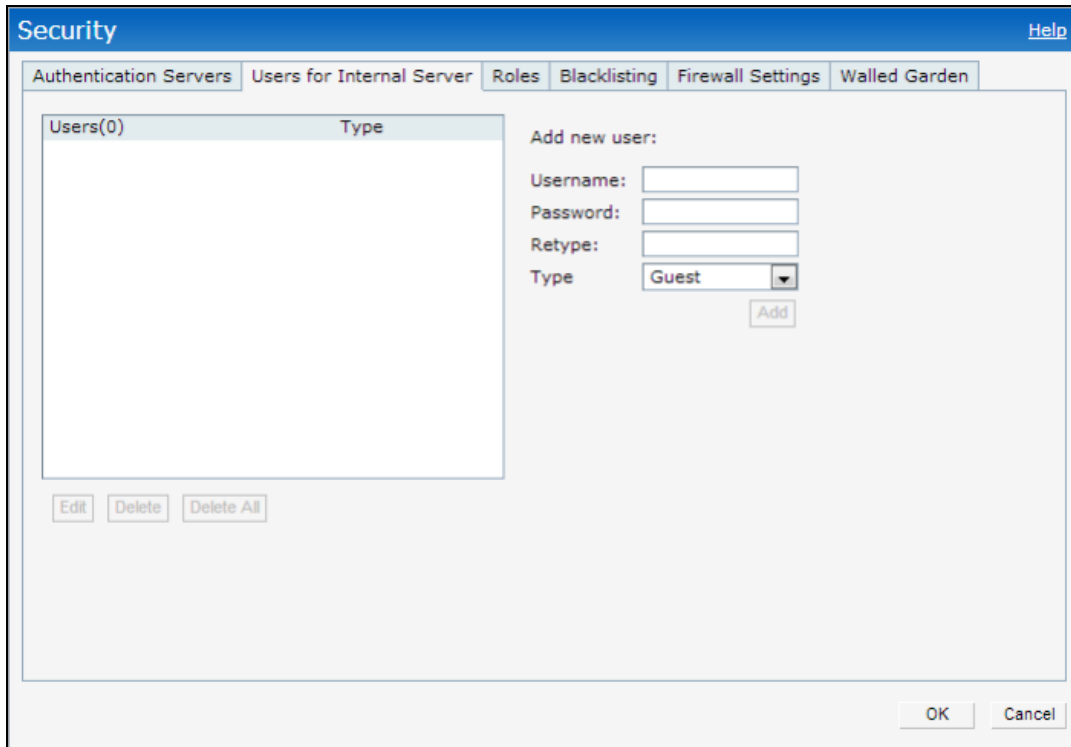

3. Enter the user name in the **Username** text box.
4. Enter the password in the **Password** text box and reconfirm.
5. Select a type of network from the **Type** drop-down list.
6. Click **Add** and click **OK**. The users are listed in the **Users** list.
7. To edit user settings:
 - a. Select the user to modify under **Users**
 - b. Click **Edit** to modify user settings.
 - c. Click **OK**.
8. To delete a user:
 - a. In the **Users** section, select the username to delete
 - b. Click **Delete**.
 - c. Click **OK**.
9. To delete all or multiple users at a time:
 - a. Select the user names that you want to delete
 - b. Click **Delete All**.
 - c. Click **OK**.



Deleting a user only removes the user record from the user database, and will not disconnect the online user associated with the user name.

In the CLI

To configure an employee user:

```
(Instant AP) (config)# user <username> <password> radius
(Instant AP) (config)# end
(Instant AP)# commit apply
```

To configure a guest user:

```
(Instant AP) (config)# user <username> <password> portal
(Instant AP) (config)# end
(Instant AP)# commit apply
```

Configuring Authentication Parameters for Management Users

You can configure RADIUS or TACACS authentication servers to authenticate and authorize the management users of an OAW-IAP. The authentication servers determine if the user has access to administrative interface. The privilege level for different types of management users is defined on the RADIUS or TACACS server instead of the OAW-IAP. The OAW-IAPs map the management users to the corresponding privilege level and provide access to the users based on the attributes returned by the RADIUS or TACACS server.

You can configure authentication parameters for local admin, read-only, and guest management administrator account settings through the AOS-W Instant UI or CLI.

In the AOS-W Instant UI

1. Navigate to **System > Admin**. The **Admin** tab details are displayed.

Type of the User	Authentication Options	Steps to Follow
Local administrator	Internal	Select Internal if you want to specify a single set of user credentials. If using an internal authentication server: <ol style="list-style-type: none"> 1. Specify a Username and Password. 2. Retype the password to confirm.
	Authentication server	Select the RADIUS or TACACS authentication servers. You can also create a new server by selecting New from the Authentication server drop-down list. <ul style="list-style-type: none"> • Authentication server w/ fallback to internal—Select Authentication server w/ fallback to internal option if you want to use both internal and external servers. When enabled, the authentication switches to Internal if there is no response from the RADIUS server (RADIUS server timeout). To use this option, select the authentication servers and configure the user credentials for internal server based authentication. • Load balancing—If two servers are configured, users can use them in the primary or backup mode, or load balancing mode. To enable load balancing, select Enabled from the Load balancing drop-down list. For more information on load balancing, see Dynamic Load Balancing between Two Authentication Servers on page 163. • TACACS accounting—If a TACACS server is selected, enable TACACS accounting to report management commands if required.
View Only	Internal —Select this option to specify a single set of user credentials.	If using an internal authentication server: <ol style="list-style-type: none"> 1. Specify a Username and Password. 2. Retype the password to confirm.

Type of the User	Authentication Options	Steps to Follow
	Authentication server	If a RADIUS or TACACS server is configured, select Authentication server for authentication.
Guest Registration Only	Internal —Select this option to specify a single set of user credentials.	If using an internal authentication server: 1. Specify the Username and Password . 2. Retype the password to confirm.
	Authentication server	If a RADIUS or TACACS server is configured, select Authentication server for authentication.

3. Click **OK**.

In the CLI

To configure a local admin user:

```
(Instant AP) (config) # mgmt-user <username> [password]
```

To configure guest management administrator credentials:

```
(Instant AP) (config) # mgmt-user <username> [password] guest-mgmt
```

To configure a user with read-only privilege:

```
(Instant AP) (config) # mgmt-user <username> [password] read-only
```

To configure management authentication settings:

```
(Instant AP) (config) # mgmt-auth-server <server1>
(Instant AP) (config) # mgmt-auth-server <server2>
(Instant AP) (config) # mgmt-auth-server-load-balancing
(Instant AP) (config) # mgmt-auth-server-local-backup
```

To enable TACACS accounting:

```
(Instant AP) (config) # mgmt-accounting command all
```

Adding Guest Users through the Guest Management Interface

To add guest users through the Guest Management interface:

1. Log in to AOS-W Instant UI with the guest management interface administrator credentials. The guest management interface is displayed.

Figure 35 *Guest Management Interface*

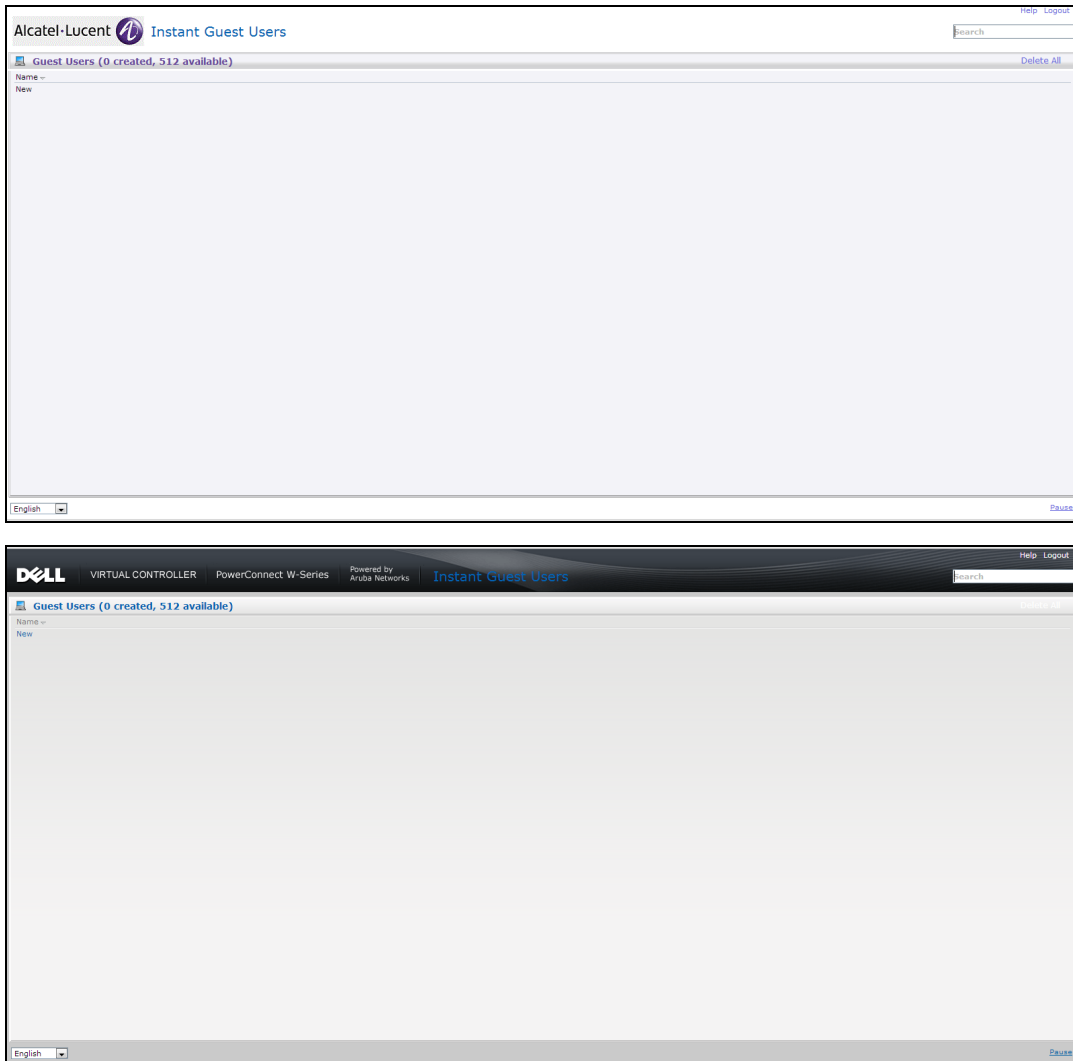

2. To add a user, click **New**. The **New Guest User** pop-up window is displayed.
3. Specify a **Username** and **Password**.
4. Retype the password to confirm.
5. Click **OK**.

Supported Authentication Methods

Authentication is a process of identifying a user by through a valid user name and password or based on their MAC addresses. The following authentication methods are supported in AOS-W Instant:

- 802.1X Authentication
- MAC Authentication
- MAC Authentication with 802.1X Authentication
- Captive Portal Authentication
- MAC authentication with Captive Portal authentication
- 802.1X authentication with Captive Portal Role
- WISPr authentication

802.1X Authentication

802.1X is an IEEE standard that provides an authentication framework for WLANs. 802.1X uses the Extensible Authentication Protocol (EAP) to exchange messages during the authentication process. The authentication protocols that operate inside the 802.1X framework include EAP-Transport Layer Security (EAP-TLS), Protected EAP (PEAP), and EAP-Tunneled TLS (EAP-TTLS). These protocols allow the network to authenticate the client while also allowing the client to authenticate the network. For more information on EAP authentication framework supported by the OAW-IAP, see [Supported EAP Authentication Frameworks on page 157](#).

802.1X authentication method allows an OAW-IAP to authenticate the identity of a user before providing network access to the user. The Remote Authentication Dial In User Service (RADIUS) protocol provides centralized authentication, authorization, and accounting management. For authentication purpose, the wireless client can associate to a network access server (NAS) or RADIUS client such as a wireless OAW-IAP. The wireless client can pass data traffic only after successful 802.1X authentication.

For more information on configuring an OAW-IAP to use 802.1X authentication, see [Configuring 802.1X Authentication for a Network Profile on page 174](#).

MAC Authentication

MAC authentication is used for authenticating devices based on their physical MAC addresses. MAC authentication requires that the MAC address of a machine matches a manually defined list of addresses. This authentication method is not recommended for scalable networks and the networks that require stringent security settings. For more information on configuring an OAW-IAP to use MAC authentication, see [Configuring MAC Authentication for a Network Profile on page 178](#).

MAC Authentication with 802.1X Authentication

This authentication method has the following features:

- MAC authentication precedes 802.1X authentication - The administrators can enable MAC authentication for 802.1X authentication. MAC authentication shares all the authentication server configurations with 802.1X authentication. If a wireless or wired client connects to the network, MAC authentication is performed first. If MAC authentication fails, 802.1X authentication does not trigger. If MAC authentication is successful, 802.1X authentication is attempted. If 802.1X authentication is successful, the client is assigned an 802.1X authentication role. If 802.1X authentication fails, the client is assigned a **deny-all** role or **mac-auth-only** role.
- MAC authentication only role - Allows you to create a **mac-auth-only** role to allow role-based access rules when MAC authentication is enabled for 802.1X authentication. The **mac-auth-only** role is assigned to a client when the MAC authentication is successful and 802.1X authentication fails. If 802.1X authentication is successful, the **mac-auth-only** role is overwritten by the final role. The **mac-auth-only** role is primarily used for wired clients.
- L2 authentication fall-through - Allows you to enable the **l2-authentication-fallthrough** mode. When this option is enabled, the 802.1X authentication is allowed even if the MAC authentication fails. If this option is disabled, 802.1X authentication is not allowed. The **l2-authentication-fallthrough** mode is disabled by default.

For more information on configuring an OAW-IAP to use MAC + 802.1X Authentication, see [Configuring MAC Authentication with 802.1X Authentication on page 180](#).

Captive Portal Authentication

Captive portal authentication is used for authenticating guest users. For more information on captive portal authentication, see [Captive Portal for Guest Access on page 124](#).

MAC authentication with Captive Portal authentication

You can enforce MAC authentication for captive portal clients. For more information configuring an OAW-IAP to use MAC authentication with captive portal authentication, see [Configuring MAC Authentication with Captive Portal Authentication on page 181](#).

802.1X authentication with Captive Portal Role

This authentication mechanism allows you to configure different captive portal settings for clients on the same SSID. For example, you can configure an 802.1X SSID and create a role for captive portal access, so that some of the clients using the SSID derive the captive portal role. You can configure rules to indicate access to external or internal captive portal, or none. For more information on configuring captive portal roles for an SSID with 802.1X authentication, see [Configuring Captive Portal Roles for an SSID on page 145](#).

WISPr authentication

Wireless Internet Service Provider roaming (WISPr) authentication allows a smart client to authenticate on the network when they roam between wireless Internet service providers, even if the wireless hotspot uses an Internet Service Provider (ISP) with whom the client may not have an account.

If a hotspot is configured to use WISPr authentication in a specific ISP and a client attempts to access the Internet at that hotspot, the WISPr AAA server configured for the ISP authenticates the client directly and allows the client to access the network. If the client only has an account with a *partner* ISP, the WISPr AAA server forwards the client's credentials to the partner ISP's WISPr AAA server for authentication. When the client is authenticated on the partner ISP, it is also authenticated on your hotspot's own ISP as per their service agreements. The OAW-IAP assigns the default WISPr user role to the client when your ISP sends an authentication message to the OAW-IAP. For more information on WISPr authentication, see [Configuring WISPr Authentication on page 182](#).

Supported EAP Authentication Frameworks

The following EAP authentication frameworks are supported in the AOS-W Instant network:

- EAP-TLS— The Extensible Authentication Protocol-Transport Layer Security (EAP-TLS) method supports the termination of EAP-TLS security using the internal RADIUS server. The EAP-TLS requires both server and certification authority (CA) certificates installed on the OAW-IAP. The client certificate is verified on the Virtual Controller (the client certificate must be signed by a known CA), before the username is verified on the authentication server.
- EAP-TTLS (MSCHAPv2)— The Extensible Authentication Protocol-Tunneled Transport Layer Security (EAP-TTLS) method uses server-side certificates to set up authentication between clients and servers. However, the actual authentication is performed using passwords.
- EAP-PEAP (MSCHAPv2)— EAP-PEAP is an 802.1X authentication method that uses server-side public key certificates to authenticate clients with server. The PEAP authentication creates an encrypted SSL / TLS tunnel between the client and the authentication server. Exchange of information is encrypted and stored in the tunnel ensuring the user credentials are kept secure.
- LEAP— Lightweight Extensible Authentication Protocol (LEAP) uses dynamic WEP keys for authentication between the client and authentication server.

To use the OAW-IAP's internal database for user authentication, add the names and passwords of the users to be authenticated.



Alcatel-Lucent does not recommend the use of LEAP authentication, because it does not provide any resistance to network attacks.

Authentication Termination on OAW-IAP

OAW-IAPs support EAP termination for enterprise WLAN SSIDs. The EAP termination can reduce the number of exchange packets between the OAW-IAP and the authentication servers. AOS-W Instant allows Extensible Authentication Protocol (EAP) termination for Protected Extensible Authentication Protocol (PEAP)-Generic Token Card (PEAP-GTC) and Protected Extensible Authentication Protocol-Microsoft Challenge Authentication Protocol version 2 (PEAP-MSCHAV2). PEAP-GTC termination allows authorization against an Lightweight Directory Access Protocol (LDAP) server and external RADIUS server while PEAP-MSCHAV2 allows authorization against an external RADIUS server.

This allows the users to run PEAP-GTC termination with their username and password to a local Microsoft Active Directory server with LDAP authentication.

- EAP-Generic Token Card (GTC)— This EAP method permits the transfer of unencrypted usernames and passwords from client to server. The main uses for EAP-GTC are one-time token cards such as SecureID and the use of LDAP or RADIUS as the user authentication server. You can also enable caching of user credentials on the OAW-IAP to an external authentication server for user data backup.
- EAP-Microsoft Challenge Authentication Protocol version 2 (MS-CHAPv2)— This EAP method is widely supported by Microsoft clients. A RADIUS server must be used as the back-end authentication server.

Configuring Authentication Servers

This section describes the following procedures:

- [Configuring an External Server for Authentication on page 163](#)
- [Enabling RADIUS Communication over TLS on page 168](#)
- [Configuring Dynamic RADIUS Proxy Parameters on page 170](#)

Supported Authentication Servers

Based on the security requirements, you can configure internal or external authentication servers. This section describes the types of servers that can be configured for client authentication:

- [Internal RADIUS Server on page 158](#)
- [External RADIUS Server on page 159](#)
- [Dynamic Load Balancing between Two Authentication Servers on page 163](#)

In 6.4.0.2-4.1 release, you can configure TACACS+ server for authenticating management users. For more information, on management users and TACACS+ server based authentication, see [Configuring Authentication Parameters for Management Users](#) .

Internal RADIUS Server

Each OAW-IAP has an instance of free RADIUS server operating locally. When you enable the internal RADIUS server option for the network, the client on the OAW-IAP sends a RADIUS packet to the local IP address. The internal RADIUS server listens and replies to the RADIUS packet. Instant serves as a RADIUS server for 802.1X authentication. However, the internal RADIUS server can also be configured as a backup RADIUS server for an external RADIUS server.

External RADIUS Server

In the external RADIUS server, the IP address of the Virtual Controller is configured as the NAS IP address. AOS-W Instant RADIUS is implemented on the Virtual Controller, and this eliminates the need to configure multiple NAS clients for every OAW-IAP on the RADIUS server for client authentication. AOS-W Instant RADIUS dynamically forwards all the authentication requests from a NAS to a remote RADIUS server. The RADIUS server responds to the authentication request with an **Access-Accept** or **Access-Reject** message, and the clients are allowed or denied access to the network depending on the response from the RADIUS server. When you enable an external RADIUS server for the network, the client on the OAW-IAP sends a RADIUS packet to the local IP address. The external RADIUS server then responds to the RADIUS packet.

AOS-W Instant supports the following external authentication servers:

- RADIUS (Remote Authentication Dial-In User Service)
- LDAP (Lightweight Directory Access Protocol)
- ClearPass Policy Manager Server for AirGroup CoA

To use an LDAP server for user authentication, configure the LDAP server on the Virtual Controller, and configure user IDs and passwords. To use a RADIUS server for user authentication, configure the RADIUS server on the Virtual Controller.

RADIUS Server Authentication with VSA

An external RADIUS server authenticates network users and returns to the OAW-IAP the vendor-specific attribute (VSA) that contains the name of the network role for the user. The authenticated user is placed into the management role specified by the VSA.

AOS-W Instant supports the following VSAs for user role and VLAN derivation rules:

- AP-Group
- AP-Name
- ARAP-Features
- ARAP-Security
- ARAP-Security-Data
- ARAP-Zone-Access
- Acct-Authentic
- Acct-Delay-Time
- Acct-Input-Gigawords
- Acct-Input-Octets
- Acct-Input-Packets
- Acct-Interim-Interval
- Acct-Link-Count
- Acct-Multi-Session-Id
- Acct-Output-Gigawords
- Acct-Output-Octets
- Acct-Output-Packets
- Acct-Session-Id
- Acct-Session-Time
- Acct-Status-Type
- Acct-Terminate-Cause
- Acct-Tunnel-Packets-Lost

- Add-Port-To-IP-Address
- Aruba-AP-Group
- Aruba-AP-IP-Address
- Aruba-AS-Credential-Hash
- Aruba-AS-User-Name
- Aruba-Admin-Path
- Aruba-Admin-Role
- Aruba-AirGroup-Device-Type
- Aruba-AirGroup-Shared-Group
- Aruba-AirGroup-Shared-Role
- Aruba-AirGroup-Shared-User
- Aruba-AirGroup-User-Name
- Aruba-AirGroup-Version
- Aruba-Auth-SurvMethod
- Aruba-Auth-Survivability
- Aruba-CPPM-Role
- Aruba-Calea-Server-Ip
- Aruba-Device-Type
- Aruba-Essid-Name
- Aruba-Framed-IPv6-Address
- Aruba-Location-Id
- Aruba-Mdps-Device-Iccid
- Aruba-Mdps-Device-Imei
- Aruba-Mdps-Device-Name
- Aruba-Mdps-Device-Product
- Aruba-Mdps-Device-Profile
- Aruba-Mdps-Device-Serial
- Aruba-Mdps-Device-Udid
- Aruba-Mdps-Device-Version
- Aruba-Mdps-Max-Devices
- Aruba-Mdps-Provisioning-Settings
- Aruba-Named-User-Vlan
- Aruba-Network-SSO-Token
- Aruba-No-DHCP-Fingerprint
- Aruba-Port-Bounce-Host
- Aruba-Port-Id
- Aruba-Priv-Admin-User
- Aruba-Template-User
- Aruba-User-Group
- Aruba-User-Role
- Aruba-User-Vlan
- Aruba-WorkSpace-App-Name

- Authentication-Sub-Type
- Authentication-Type
- CHAP-Challenge
- Callback-Id
- Callback-Number
- Chargeable-User-Identity
- Class
- Connect-Info
- Connect-Rate
- Crypt-Password
- DB-Entry-State
- Digest-Response
- Domain-Name
- EAP-Message
- Error-Cause
- Event-Timestamp
- Exec-Program
- Exec-Program-Wait
- Expiration
- Fall-Through
- Filter-Id
- Framed-AppleTalk-Link
- Framed-AppleTalk-Network
- Framed-AppleTalk-Zone
- Framed-Compression
- Framed-IP-Address
- Framed-IP-Netmask
- Framed-IPX-Network
- Framed-IPv6-Pool
- Framed-IPv6-Prefix
- Framed-IPv6-Route
- Framed-Interface-Id
- Framed-MTU
- Framed-Protocol
- Framed-Route
- Framed-Routing
- Full-Name
- Group
- Group-Name
- Hint
- Huntgroup-Name
- Idle-Timeout

- Location-Capable
- Location-Data
- Location-Information
- Login-IP-Host
- Login-IPv6-Host
- Login-LAT-Node
- Login-LAT-Port
- Login-LAT-Service
- Login-Service
- Login-TCP-Port
- Menu
- Message-Auth
- NAS-IPv6-Address
- NAS-Port-Type
- Operator-Name
- Password
- Password-Retry
- Port-Limit
- Prefix
- Prompt
- Rad-Authenticator
- Rad-Code
- Rad-Id
- Rad-Length
- Reply-Message
- Requested-Location-Info
- Revoke-Text
- Server-Group
- Server-Name
- Service-Type
- Session-Timeout
- Simultaneous-Use
- State
- Strip-User-Name
- Suffix
- Termination-Action
- Termination-Menu
- Tunnel-Assignment-Id
- Tunnel-Client-Auth-Id
- Tunnel-Client-Endpoint
- Tunnel-Connection-Id
- Tunnel-Medium-Type

- Tunnel-Preference
- Tunnel-Private-Group-Id
- Tunnel-Server-Auth-Id
- Tunnel-Server-Endpoint
- Tunnel-Type
- User-Category
- User-Name
- User-Vlan
- Vendor-Specific
- fw_mode
- dhcp-option
- dot1x-authentication-type
- mac-address
- mac-address-and-dhcp-options

TACACS Servers

You can now configure a TACACS+ server as the authentication server to authenticate and authorize all types of management users, and account user sessions. When configured, the TACACS+ server allows a remote access server to communicate with an authentication server to determine if the user has access to the network. The OAW-IAP users can create several TACACS+ server profiles and associate these profiles to the user accounts to enable authentication of the management users.

TACACS+ supports the following types of authentication:

- ASCII
- PAP
- CHAP
- ARAP
- MSCHAP



The TACACS+ server cannot be attributed to any SSID or wired profile in general as the authentication server and is configured only for the OAW-IAP management users.

Dynamic Load Balancing between Two Authentication Servers

You can configure two authentication servers to serve as a primary and backup RADIUS server and enable load balancing between these servers. Load balancing of authentication servers ensures that the authentication load is split across multiple authentication servers and enables the OAW-IAPs to perform load balancing of authentication requests destined to authentication servers such as RADIUS or LDAP.

The load balancing in OAW-IAP is performed based on outstanding authentication sessions. If there are no outstanding sessions and if the rate of authentication is low, only primary server will be used. The secondary is used only if there are outstanding authentication sessions on the primary server. With this, the load balance can be performed across asymmetric capacity RADIUS servers without the need to obtain inputs about the server capabilities from the administrators.

Configuring an External Server for Authentication

You can configure RADIUS, TACACS, LDAP, and ClearPass Policy Manager servers through the AOS-W Instant UI or CLI.

In the AOS-W Instant UI

To configure an authentication server:

1. Navigate to **Security>Authentication Servers**. The **Security** window is displayed.
2. To create a new server, click **New**. A window for specifying details for the new server is displayed.
3. Configure parameters based on the type of sever.
 - **RADIUS**—To configure a RADIUS server, specify the attributes described in the following table:

Table 31: RADIUS Server Configuration Parameters

Parameter	Description
Name	Enter a name for the server.
Server address	Enter the host name or the IP address of the external RADIUS server.
RadSec	<p>Set RadSec to Enabled to enable secure communication between the RADIUS server and OAW-IAP clients by creating a TLS tunnel between the OAW-IAP and the server.</p> <p>If RadSec is enabled, the following configuration options are displayed:</p> <ul style="list-style-type: none">● RadSec port— Communication port number for RadSec TLS connection. By default, the port number is set to 2083.● RFC 3576—When set to Enabled, it allows the APs to process RFC 3576-compliant Change of Authorization (CoA) and disconnect messages from the RADIUS server.● NAS IP address● NAS identifier <p>For more information on RadSec configuration, see Enabling RADIUS Communication over TLS on page 168.</p>
Auth port	Enter the authorization port number of the external RADIUS server within the range of 1–65535. The default port number is 1812.
Accounting port	Enter the accounting port number within the range of 1–65535. This port is used for sending accounting records to the RADIUS server. The default port number is 1813.
Shared key	Enter a shared key for communicating with the external RADIUS server.
Retype key	Re-enter the shared key.
Timeout	Specify a timeout value in seconds. The value determines the timeout for one RADIUS request. The OAW-IAP retries to send the request several times (as configured in the Retry count), before the user gets disconnected. For example, if the Timeout is 5 seconds, Retry counter is 3, user is disconnected after 20 seconds. The default value is 5 seconds.
Retry count	Specify a number between 1 and 5. Indicates the maximum number of authentication requests that are sent to the server group, and the default value is 3 requests.
RFC 3576	Select Enabled to allow the APs to process RFC 3576-compliant Change of Authorization (CoA) and disconnect messages from the RADIUS server. Disconnect messages cause a user session to be terminated immediately, whereas the CoA messages modify session authorization attributes such as data filters.

Parameter	Description
NAS IP address	Allows you to configure an arbitrary IP address to be used as RADIUS Attribute 4, NAS IP Address, without changing source IP Address in IP header of RADIUS packet. NOTE: If you do not enter the IP address, the Virtual Controller IP address is used by default when Dynamic RADIUS Proxy is enabled.
NAS Identifier	Allows you to configure strings for RADIUS attribute 32, NAS Identifier, to be sent with RADIUS requests to the RADIUS server.
Dead Time	Specify a dead time for authentication server in minutes. When two or more authentication servers are configured on the OAW-IAP and a server is unavailable, the dead time configuration determines the duration for which the authentication server would be available if the server is marked as unavailable.
Dynamic RADIUS proxy parameters	Specify the following dynamic RADIUS proxy parameters: <ul style="list-style-type: none"> • DRP IP— IP address to be used as source IP for RADIUS packets • DRP Mask—Subnet mask of the DRP IP address. • DRP VLAN—VLAN in which the RADIUS packets are sent. • DRP Gateway—Gateway IP address of the DRP VLAN. For more information on dynamic RADIUS proxy parameters and configuration procedure, see Configuring Dynamic RADIUS Proxy Parameters on page 170 .

To assign the RADIUS authentication server to a network profile, select the newly added server when configuring security settings for a wireless or wired network profile.



You can also add an external RADIUS server by selecting the **New** option when configuring a WLAN or wired profile. For more information, see [Configuring Security Settings for a WLAN SSID Profile on page 98](#) and [Configuring Security Settings for a Wired Profile on page 117](#).

- **LDAP** —To configure an LDAP server, select the **LDAP** option and configure the attributes described in the following table:

Table 32: *LDAP Server Configuration Parameters*

Parameter	Description
Name	Enter a name for the server.
IP address	Enter the IP address of the LDAP server.
Auth port	Enter the authorization port number of the LDAP server. The default port number is 389.
Admin-DN	Enter a distinguished name for the admin user with read/search privileges across all the entries in the LDAP database (the user need not have write privileges, but the user must be able to search the database, and read attributes of other users in the database).
Admin password	Enter a password for administrator.

Parameter	Description
Base-DN	Enter a distinguished name for the node that contains the entire user database.
Filter	Specify the filter to apply when searching for a user in the LDAP database. The default filter string is (objectclass=*) .
Key Attribute	Specify the attribute to use as a key while searching for the LDAP server. For Active Directory, the value is sAMAccountName
Timeout	Enter a value between 1 and 30 seconds. The default value is 5.
Retry count	Enter a value between 1 and 5. The default value is 3.
Dead Time	Specify a dead time for authentication server in minutes within the range of 1-1440 minutes. The default dead time interval is 5 minutes. When two or more authentication servers are configured on the OAW-IAP and a server is unavailable, the dead time configuration determines the duration for which the authentication server would be available if the server is marked as unavailable.

- **TACACS**—To configure TACACS server, select the **TACACS** option and configure the following parameters:

Table 33: TACACS Configuration Parameters

Parameter	Description
Name	Enter a name for the server.
IP address	Enter the IP address of the TACACS server.
Auth Port	Enter a TCP IP port used by the server. The default port number is 49.
Shared Key	Enter a secret key of your choice to authenticate communication between the TACACS+ client and server.
Retype Key	Re-enter shared key.
Timeout	Enter a number between 1 and 30 seconds to indicate the timeout period for TACACS+ requests. The default value is 20 seconds.
Retry Count	Enter a number between 1 and 5 to indicate the maximum number of authentication attempts. The default value is 3.
Dead time	Specify a dead time in minutes within the range of 1-1440 minutes. The default dead time interval is 5 minutes.
Session authorization	Enables or disables session authorization. When enabled, the optional authorization session is turned on for the admin users. By default, session authorization is disabled.



You can also add TACACS server by selecting the **New** option when configuring authentication parameters for management users. For more information, see [Configuring Authentication Parameters for Management Users on page 153](#).

- **CPPM Server** for AirGroup CoA—To configure a ClearPass Policy Manager server used for AirGroup CoA (Change of Authorization), select the **CoA only** checkbox. The RADIUS server is automatically selected.

Table 34: ClearPass Policy Manager Server Configuration Parameters for AirGroup CoA

Parameter	Description
Name	Enter the name of the server.
Server address	Enter the host name or IP address of the server.
Air Group CoA port	Enter a port number for sending AirGroup CoA on a different port than on the standard CoA port. The default value is 5999.
Shared key	Enter a shared key for communicating with the external RADIUS server.
Retype key	Re-enter the shared key.

4. Click **OK**.



The ClearPass Policy Manager server acts as a RADIUS server and asynchronously provides the AirGroup parameters for the client device including shared user, role, and location.

In the CLI

To configure a RADIUS server with DRP parameters:

```
(Instant AP) (config)# wlan auth-server <profile-name>
(Instant AP) (Auth Server <profile-name>)# ip <host>
(Instant AP) (Auth Server <profile-name>)# key <key>
(Instant AP) (Auth Server <profile-name>)# port <port>
(Instant AP) (Auth Server <profile-name>)# acctport <port>
(Instant AP) (Auth Server <profile-name>)# nas-id <NAS-ID>
(Instant AP) (Auth Server <profile-name>)# nas-ip <NAS-IP-address>
(Instant AP) (Auth Server <profile-name>)# timeout <seconds>
(Instant AP) (Auth Server <profile-name>)# retry-count <number>
(Instant AP) (Auth Server <profile-name>)# rfc3576
(Instant AP) (Auth Server <profile-name>)# deadtime <minutes>
(Instant AP) (Auth Server <profile-name>)# drp-ip <IP-address> <mask> vlan <vlan> gateway
<gateway-IP-address>
(Instant AP) (Auth Server <profile-name>)# end
(Instant AP)# commit apply
```

To enable RadSec:

```
(Instant AP) (config)# wlan auth-server <profile-name>
(Instant AP) (Auth Server "name")# ip <host>
(Instant AP) (Auth Server "name")# radsec [port <port>]
(Instant AP) (Auth Server "name")# rfc3576
(Instant AP) (Auth Server "name")# nas-id <id>
(Instant AP) (Auth Server "name")# nas-ip <ip>
(Instant AP) (Auth Server "name")# end
(Instant AP) (Auth Server "name")# commit apply
```

To configure an LDAP server:

```
(Instant AP) (config)# wlan ldap-server <profile-name>
(Instant AP) (LDAP Server <profile-name>)# ip <IP-address>
(Instant AP) (LDAP Server <profile-name>)# port <port>
(Instant AP) (LDAP Server <profile-name>)# admin-dn <name>
```

```
(Instant AP) (LDAP Server <profile-name>) # admin-password <password>
(Instant AP) (LDAP Server <profile-name>) # base-dn <name>
(Instant AP) (LDAP Server <profile-name>) # filter <filter>
(Instant AP) (LDAP Server <profile-name>) # key-attribute <key>
(Instant AP) (LDAP Server <profile-name>) # timeout <seconds>
(Instant AP) (LDAP Server <profile-name>) # retry-count <number>
(Instant AP) (LDAP Server <profile-name>) # deadtime <minutes>
(Instant AP) (LDAP Server <profile-name>) # end
(Instant AP) # commit apply
```

To configure a TACACS+ server:

```
(Instant AP) (config) # wlan tacacs-server <profile-name>
(Instant AP) (TACACS Server <profile-name>) # ip <IP-address>
(Instant AP) (TACACS Server <profile-name>) # port <port>
(Instant AP) (TACACS Server <profile-name>) # key <key>
(Instant AP) (TACACS Server <profile-name>) # timeout <seconds>
(Instant AP) (TACACS Server <profile-name>) # retry-count <number>
(Instant AP) (TACACS Server <profile-name>) # deadtime <minutes>
(Instant AP) (TACACS Server <profile-name>) # end
```

To configure a ClearPass Policy Manager server used for AirGroup CoA:

```
(Instant AP) (config) # wlan auth-server <profile-name>
(Instant AP) (Auth Server <profile-name>) # ip <host>
(Instant AP) (Auth Server <profile-name>) # key <key>
(Instant AP) (Auth Server <profile-name>) # cppm-rfc3576-port <port>
(Instant AP) (Auth Server <profile-name>) # cppm-rfc3576-only
(Instant AP) (Auth Server <profile-name>) # end
(Instant AP) # commit apply
```

Enabling RADIUS Communication over TLS

You can configure an OAW-IAP to use Transport Layer Security (TLS) tunnel and to enable secure communication between the RADIUS server and OAW-IAP clients. Enabling RADIUS communication over TLS increases the level of security for authentication that is carried out across the cloud network. When configured, this feature ensures that RadSec protocol is used for safely transmitting the authentication and accounting data between the OAW-IAP clients and the RADIUS server in cloud.

The following configuration conditions apply to RadSec configuration:

- When the TLS tunnel is established, RADIUS packets will go through the tunnel and server adds CoA on this tunnel.
- By default, the TCP port 2083 is assigned for RadSec. Separate ports are not used for authentication, accounting and dynamic authorization changes.
- AOS-W Instant supports dynamic CoA (RFC 3576) over RadSec and the RADIUS server uses an existing TLS connection opened by the OAW-IAP to send the request.
- For authentication between the OAW-IAP clients and the TLS server, RadSec certificate must be uploaded to OAW-IAP. For more information on uploading certificates, see [Uploading Certificates on page 186](#).

Configuring RadSec Protocol

In the UI

To configure RadSec protocol in the UI:

1. Navigate to **Security>Authentication Servers**. The **Security** window is displayed.
2. To create a new server, click **New**. A pop-up for specifying details for the new server is displayed.
3. Under RADIUS Server, configure the following parameters:
 - a. Enter the name of the server.

- b. Enter the host name or the IP address of the server.
 - c. Select **Enabled** to enable RadSec.
 - d. Ensure that the port defined for RadSec is correct. By default, the port number is set to 2083.
 - e. To allow the APs to process RFC 3576-compliant Change of Authorization (CoA) and disconnect messages from the RADIUS server, set **RFC 3576** to **Enabled**. Disconnect messages cause a user session to be terminated immediately, whereas the CoA messages modify session authorization attributes such as data filters.
 - f. If **RFC 3576** is enabled, specify an AirGroup CoA port if required.
 - g. Enter the NAS IP address.
 - h. Specify the NAS identifier to configure strings for RADIUS attribute 32 and to send it with RADIUS requests to the RADIUS server.
4. Click **OK**.

In the CLI

Execute the following commands:

```
(Instant AP) (config)# wlan auth-server <profile-name>
(Instant AP) (Auth Server "name")# ip <host>
(Instant AP) (Auth Server "name")# radsec [port <port>]
(Instant AP) (Auth Server "name")# rfc3576
(Instant AP) (Auth Server "name")# nas-id <id>
(Instant AP) (Auth Server "name")# nas-ip <ip>
(Instant AP) (Auth Server "name")# end
(Instant AP) (Auth Server "name")# commit apply
```

Associate the Server Profile with a Network Profile

1. Access the WLAN wizard or Wired Settings window.
 - To open the WLAN wizard, select an existing SSID on the **Network** tab, and click **edit**.
 - To open the wired settings window, click **More > Wired**. In the **Wired** window, select a profile and click **Edit**.

You can also associate the authentication servers when creating a new WLAN or wired profile.

2. Click the **Security** tab and select a splash page profile.
3. Select an authentication type.
4. From the **Authentication Server 1** drop-down list, select the server name on which RadSec is enabled.
5. Click **Next** and then click **Finish**.

In the CLI

To associate an authentication server to a WLAN SSID:

```
(Instant AP) (config)# wlan ssid-profile <name>
(Instant AP) (SSID Profile <name>)# auth-server <server-name>
(Instant AP) (SSID Profile <name>)# end
((Instant AP)# commit apply
```

To associate an authentication server to a wired profile:

```
(Instant AP) (config)# wired-port-profile <name>
(Instant AP) (wired ap profile <name>)# auth-server <name>
(Instant AP) (wired ap profile <name>)# end
(Instant AP)# commit apply
```

Configuring Dynamic RADIUS Proxy Parameters

The RADIUS server can be deployed at different locations and VLANs. In most cases, a centralized RADIUS or local server is used to authenticate users. However, some user networks can use a local RADIUS server for employee authentication and a centralized RADIUS based captive portal server for guest authentication. To ensure that the RADIUS traffic is routed to the required RADIUS server, the dynamic RADIUS proxy feature must be enabled.



The dynamic RADIUS proxy parameters configuration is not required if RadSec is enabled in the RADIUS server profile.

If the OAW-IAP clients need to authenticate to the RADIUS servers through a different IP address and VLAN, ensure that the following steps are completed:

1. [Enable dynamic RADIUS proxy.](#)
2. [Configure dynamic RADIUS proxy IP, VLAN, netmask, gateway for each authentication server.](#)
3. [Associate the authentication servers to SSID or a wired profile to which the clients connect.](#)

After completing the above-mentioned configuration steps, you can authenticate the SSID users against the configured dynamic RADIUS proxy parameters.

Enabling Dynamic RADIUS Proxy

You can enable RADIUS Server Support using the AOS-W Instant UI or CLI.

In the AOS-W Instant UI

To enable RADIUS server support:

1. In the AOS-W Instant main window, click the **System** link. The **System** window is displayed.
2. On the **General** tab of the **System** window, select the **RADIUS** checkbox for **Dynamic Proxy**.
3. Click **OK**.



When dynamic RADIUS proxy is enabled, the Virtual Controller network uses the IP Address of the Virtual Controller for communication with external RADIUS servers. Ensure that the Virtual Controller IP Address is set as a NAS IP when configuring RADIUS server attributes with dynamic RADIUS proxy enabled. For more information on configuring RADIUS server attributes, see [Configuring an External Server for Authentication on page 163](#).

In case of VPN deployments, the tunnel IP received when establishing a VPN connection is used as the NAS IP. In such cases, the Virtual controller IP need not be configured for the external RADIUS servers.

In the CLI

To enable the dynamic RADIUS proxy feature:

```
(Instant AP) (config)# dynamic-radius-proxy
(Instant AP) (config)# end
(Instant AP)# commit apply
```

Configuring Dynamic RADIUS Proxy Parameters

You can configure DRP parameters for the authentication server by using the AOS-W Instant UI or CLI.

In the AOS-W Instant UI

1. Click the **Security>Authentication Servers**.
2. To create a new server, click **New** and configure the required RADIUS server parameters as described in [Table 31](#).

3. Ensure that the following dynamic RADIUS proxy parameters are configured:
 - **DRP IP**— IP address to be used as source IP for RADIUS packets
 - **DRP Mask**—Subnet mask of the DRP IP address.
 - **DRP VLAN**—VLAN in which the RADIUS packets are sent.
 - **DRP Gateway**—Gateway IP address of the DRP VLAN.
4. Click **OK**.

In the CLI

To configure dynamic RADIUS proxy parameters:

```
(Instant AP) (config)# wlan auth-server <profile-name>
(Instant AP) (Auth Server <profile-name>)# ip <IP-address>
(Instant AP) (Auth Server <profile-name>)# key <key>
(Instant AP) (Auth Server <profile-name>)# port <port>
(Instant AP) (Auth Server <profile-name>)# acctport <port>
(Instant AP) (Auth Server <profile-name>)# nas-id <NAS-ID>
(Instant AP) (Auth Server <profile-name>)# nas-ip <NAS-IP-address>
(Instant AP) (Auth Server <profile-name>)# timeout <seconds>
(Instant AP) (Auth Server <profile-name>)# retry-count <number>
(Instant AP) (Auth Server <profile-name>)# deadtime <minutes>
(Instant AP) (Auth Server <profile-name>)# drp-ip <IP-address> <mask> vlan <vlan> gateway
<gateway-IP-address>
(Instant AP) (Auth Server <profile-name>)# end
(Instant AP)# commit apply
```

Associate Server Profiles to a Network Profile

To associate the authentication server profiles with a network profile:

1. Access the WLAN wizard or Wired Settings window.
 - To open the WLAN wizard, select an existing SSID on the **Network** tab, and click **edit**.
 - To open the wired settings window, click **More > Wired**. In the **Wired** window, select a profile and click **Edit**.

You can also associate the authentication servers when creating a new WLAN or wired profile.

2. Click the **Security** tab.
3. If you are configuring the authentication server for a WLAN SSID, under **Security** tab, slide to **Enterprise** security level.
4. Ensure that an authentication type is enabled.
5. From the **Authentication Server 1** drop-down list, select the server name on which dynamic RADIUS proxy parameters are enabled. You can also create a new server with RADIUS and RADIUS proxy parameters by selecting **New**.
6. Click **Next** and then click **Finish**.
7. To assign the RADIUS authentication server to a network profile, select the newly added server when configuring security settings for a wireless or wired network profile.



You can also add an external RADIUS server by selecting New for Authentication Server when configuring a WLAN or wired profile. For more information, see [Configuring Security Settings for a WLAN SSID Profile on page 98](#) and [Configuring Security Settings for a Wired Profile on page 117](#).

In the CLI

To associate an authentication server to a WLAN SSID:

```
(Instant AP) (config)# wlan ssid-profile <name>
(Instant AP) (SSID Profile <name>)# auth-server <server-name>
```

```
(Instant AP) (SSID Profile <name># end
((Instant AP)# commit apply
```

To associate an authentication server to a wired profile:

```
(Instant AP) (config)# wired-port-profile <name>
(Instant AP) (wired ap profile <name>)# auth-server <name>
(Instant AP) (wired ap profile <name>)# end
(Instant AP)# commit apply
```

Understanding Encryption Types

Encryption is the process of converting data into a cryptic format or code when it is transmitted on a network. Encryption prevents unauthorized use of the data.

AOS-W Instant supports the following types of encryption:

- **WEP**—Wired Equivalent Privacy (WEP) is an authentication method where all users share the same key. WEP is not secure as other encryption types such as TKIP.
- **TKIP**—Temporal Key Integrity Protocol (TKIP) uses the same encryption algorithm as WEP. However, TKIP is more secure and has an additional message integrity check (MIC).
- **AES**—The Advanced Encryption Standard (AES) encryption algorithm a widely supported encryption type for all wireless networks that contain any confidential data. AES in Wi-Fi leverages 802.1X or PSKs to generate per station keys for all devices. AES provides a high level of security like IP Security (IPsec) clients.



WEP and TKIP are limited to WLAN connection speed of 54 Mbps. The 802.11n connection supports only AES encryption. Alcatel-Lucent recommends AES encryption. Ensure that all devices that do not support AES are upgraded or replaced with the devices that support AES encryption.

WPA and WPA2

WPA is created based on a draft of 802.11i, which allowed users to create more secure WLANs. WPA2 encompasses the full implementation of the 802.11i standard. WPA2 is a superset that encompasses the full WPA feature set.

The following table summarizes the differences between the two certifications:

Table 35: WPA and WPA2 Features

Certification	Authentication	Encryption
WPA	<ul style="list-style-type: none"> • PSK • IEEE 802.1X with Extensible Authentication Protocol (EAP) 	TKIP with message integrity check (MIC)
WPA2	<ul style="list-style-type: none"> • PSK • IEEE 802.1X with EAP 	AES -- Counter Mode with Cipher Block Chaining Message Authentication Code (AESCCMP)

WPA and WPA2 can be further classified as follows:

- **Personal**—Personal is also called Pre-Shared Key (PSK). In this type, a unique key is shared with each client in the network. Users have to use this key to securely log in to the network. The key remains the same until it is changed by authorized personnel. You can also configure key change intervals.

- **Enterprise**—Enterprise is more secure than WPA Personal. In this type, every client automatically receives a unique encryption key after securely logging on to the network. This key is automatically updated at regular intervals. WPA uses TKIP and WPA2 uses the AES algorithm.

Recommended Authentication and Encryption Combinations

The following table summarizes the recommendations for authentication and encryption combinations for the Wi-Fi networks.

Table 36: *Recommended Authentication and Encryption Combinations*

Network Type	Authentication	Encryption
Employee	802.1X	AES
Guest Network	Captive portal	None
Voice Network or Handheld devices	802.1X or PSK as supported by the device	AES if possible, TKIP or WEP if necessary (combine with security settings assigned for a user role).

Configuring Authentication Survivability

The authentication survivability feature supports a survivable authentication framework against the remote link failure when working with the external authentication servers. When enabled, this feature allows the OAW-IAPs to authenticate the previously connected clients against the cached credentials if the connection to the authentication server is temporarily lost.

AOS-W Instant supports the following EAP standards for authentication survivability:

- **EAP-PEAP:** The Protected Extensible Authentication Protocol also known as Protected EAP or PEAP is a protocol that encapsulates EAP within a potentially encrypted and authenticated Transport Layer Security (TLS) tunnel. The EAP-PEAP supports the MSCHAPv2 and GTC methods.
- **EAP-TLS:** EAP-Transport Layer Security (EAP-TLS) is an IETF open standard that uses the Transport Layer Security (TLS) protocol.

When the authentication survivability feature is enabled, the following authentication process is used:

1. The client associates to an OAW-IAP and authenticates to the external authentication server. The external authentication server can be either ClearPass Policy Manager (for EAP-PEAP) or RADIUS server (EAP-TLS).
2. Upon successful authentication, the associated OAW-IAP caches the authentication credentials of the connected users for the configured duration. The cache expiry duration for authentication survivability can be set within the range of 1-99 hours, with 24 hours being the default cache timeout duration.
3. If the client roams or tries to reconnect to the OAW-IAP and the remote link fails due to the unavailability of the authentication server, the OAW-IAP uses the cached credentials in the internal authentication server to authenticate the user. However, if the user tries to reconnect after the cache expiry, the authentication fails.
4. When the authentication server is available and if the client tries to reconnect, the OAW-IAP detects the availability of server and allows the client to authenticate to the server. Upon successful authentication, the OAW-IAP cache details are refreshed.

Enabling Authentication Survivability

You can enable authentication survivability for a wireless network profile through the UI or CLI.

In the AOS-W Instant UI

To configure authentication survivability for a wireless network:

1. On the **Network** tab, click **New** to create a new network profile or select an existing profile for which you want to enable authentication survivability and click **edit**.
2. In the **Edit <profile-name>** or **New WLAN** window, ensure that all required WLAN and VLAN attributes are defined, and then click **Next**.
3. On the **Security** tab, under **Enterprise** security settings, select an existing authentication server or create a new server by clicking **New**.
4. To enable authentication survivability, select **Enabled** from the **Authentication survivability** drop-down. On enabling this, the OAW-IAP authenticates the previously connected clients using EAP-PEAP and EAP-TLS authentication when connection to the external authentication server is temporarily lost.
5. Specify the cache timeout duration, after which the cached details of the previously authenticated clients expire. You can specify a value within the range of 1-99 hours and the default cache timeout duration is 24 hours.
6. Click **Next** and then click **Finish** to apply the changes.

Important Points to Remember

- Any client connected through ClearPass Policy Manager and authenticated through OAW-IAP remains authenticated with the OAW-IAP even if the client is removed from the ClearPass Policy Manager server during the ClearPass Policy Manager downtime.
- Do not make any changes to the authentication survivability cache timeout duration when the authentication server is down.
- For EAP-PEAP authentication, ensure that the ClearPass Policy Manager 6.0.2 or later version is used for authentication. For EAP-TLS authentication, any external or third-party server can be used.
- For EAP-TLS authentication, ensure that the server and CA certificates from the authentication servers are uploaded on OAW-IAP. For more information, see [Uploading Certificates on page 186](#).

In the CLI

To configure authentication survivability for a wireless network:

```
(Instant AP) (config)# wlan ssid-profile <name>
(Instant AP) (SSID Profile <name>)# type {<Employee> | <Voice>| <Guest>}
(Instant AP) (SSID Profile <name>)# auth-server <server-name1>
(Instant AP) (SSID Profile <name>)# auth-survivability
(Instant AP) (SSID Profile <name>)# exit
(Instant AP) (config)# auth-survivability cache-time-out <hours>
(Instant AP) (config)# end
(Instant AP)# commit apply
```

To view the cache expiry duration:

```
(Instant AP)# show auth-survivability time-out
```

To view the information cached by the OAW-IAP:

```
(Instant AP)# show auth-survivability cached-info
```

To view logs for debugging:

```
(Instant AP)# show auth-survivability debug-log
```

Configuring 802.1X Authentication for a Network Profile

The AOS-W Instant network supports internal RADIUS server and external RADIUS server for 802.1X authentication.

The steps involved in 802.1X authentication are as follows:

1. The NAS requests authentication credentials from a wireless client.
2. The wireless client sends authentication credentials to the NAS.
3. The NAS sends these credentials to a RADIUS server.
4. The RADIUS server checks the user identity and authenticates the client if the user details are available in its database. The RADIUS server sends an *Access-Accept* message to the NAS. If the RADIUS server cannot identify the user, it stops the authentication process and sends an *Access-Reject* message to the NAS. The NAS forwards this message to the client and the client must re-authenticate with appropriate credentials.
5. After the client is authenticated, the RADIUS server forwards the encryption key to the NAS. The encryption key is used for encrypting or decrypting traffic sent to and from the client.



The NAS acts as a gateway to guard access to a protected resource. A client connecting to the wireless network first connects to the NAS.

Configuring 802.1X Authentication for a Wireless Network Profile

You can configure 802.1X authentication for a wireless network profile in the AOS-W Instant UI or CLI.

In the AOS-W Instant UI

To enable 802.1X authentication for a wireless network:

1. On the **Network** tab, click **New** to create a new network profile or select an existing profile for which you want to enable 802.1X authentication and click **edit**.
2. In the **Edit <profile-name>** or **New WLAN** window, ensure that all required WLAN and VLAN attributes are defined, and then click **Next**.
3. On the **Security** tab, specify the following parameters for the **Enterprise** security level:
 - a. Select any of the following options from the **Key management** drop-down list.
 - WPA-2 Enterprise
 - WPA Enterprise
 - Both (WPA-2 & WPA)
 - Dynamic WEP with 802.1X
4. If you do not want to use a session key from the RADIUS Server to derive pair wise unicast keys, set **Session Key for LEAP** to **Enabled**.
5. To terminate the EAP portion of 802.1X authentication on the OAW-IAP instead of the RADIUS server, set **Termination** to **Enabled**.

By default, for 802.1X authorization, the client conducts an EAP exchange with the RADIUS server, and the AP acts as a relay for this exchange. When **Termination** is enabled, the OAW-IAP by itself acts as an authentication server and terminates the outer layers of the EAP protocol, only relaying the innermost layer to the external RADIUS server.

6. Specify the type of authentication server to use and configure other required parameters. You can also configure two different authentication servers to function as primary and backup servers when termination is enabled. For more information on RADIUS authentication configuration parameters, see [Configuring an External Server for Authentication on page 163](#).
7. Click **Next** to define access rules, and then click **Finish** to apply the changes.

In the CLI

To configure 802.1X authentication for a wireless network:

```
(Instant AP) (config)# wlan ssid-profile <name>
(Instant AP) (SSID Profile <name>)# type {<Employee>|<Voice>}
```

```
(Instant AP) (SSID Profile <name>)# opmode {wpa2-aes|wpa-tkip|wpa-tkip,wpa2-aes|dynamic-wep}
(Instant AP) (SSID Profile <name>)# leap-use-session-key
(Instant AP) (SSID Profile <name>)# termination
(Instant AP) (SSID Profile <name>)# auth-server <server1>
(Instant AP) (SSID Profile <name>)# auth-server <server2>
(Instant AP) (SSID Profile <name>)# radius-reauth-interval <minutes>
(Instant AP) (SSID Profile <name>)# auth-survivability
(Instant AP) (SSID Profile <name>)# exit
(Instant AP) (config)# auth-survivability cache-time-out <hours>
(Instant AP) (config)# end
(Instant AP)# commit apply
```

Configuring 802.1X Authentication for Wired Profiles

You can configure 802.1X authentication for a wired profile in the AOS-W Instant UI or CLI.

In the AOS-W Instant UI

To enable 802.1X authentication for a wired profile:

1. Click the **Wired** link under **More** at the top right corner of the main window. The **Wired** window is displayed.
2. Click **New** under **Wired Networks** to create a new network or select an existing profile for which you want to enable 802.1X authentication and then click **Edit**.
3. In the **New Wired Network** or the **Edit Wired Network** window, ensure that all the required Wired and VLAN attributes are defined, and then click **Next**.
4. On the **Security** tab, select **Enabled** from the **802.1X authentication** drop-down list.
5. Specify the type of authentication server to use and configure other required parameters. For more information on configuration parameters, see [Configuring Security Settings for a Wired Profile on page 117](#).
6. Click **Next** to define access rules, and then click **Finish** to apply the changes.
7. Assign the profile to an Ethernet port. For more information, see [Assigning a Profile to Ethernet Ports on page 120](#).

In the CLI

To enable 802.1X authentication for a wired profile:

```
(Instant AP) (config)# wired-port-profile <name>
(Instant AP) (wired ap profile <name>)# type {<employee> |<guest>}
(Instant AP) (wired ap profile <name>)# dot1x
(Instant AP) (wired ap profile <name>)# auth-server <server1>
(Instant AP) (wired ap profile <name>)# auth-server <server2>
(Instant AP) (wired ap profile <name>)# server-load-balancing
(Instant AP) (wired ap profile <name>)# radius-reauth-interval <Minutes>
(Instant AP) (wired ap profile <name>)# end
(Instant AP)# commit apply
```

Enabling 802.1X Supplicant Support

The 802.1X authentication protocol prevents the unauthorized clients from gaining access to the network through publicly accessible ports. If the ports, to which the OAW-IAPs are connected, are configured to use the 802.1X authentication method, ensure that you configure the OAW-IAPs to function as an 802.1X client or supplicant. If your network requires all wired devices to authenticate using PEAP or TLS protocol, you need to configure the OAW-IAP uplink ports for 802.1X authentication, so that switch grants access to the OAW-IAP only after completing the authentication as a valid client.

To enable the 802.1X supplicant support on an OAW-IAP, ensure that the 802.1X authentication parameters are configured on all OAW-IAPs in the cluster and are stored securely in the OAW-IAP flash.



The 802.1X supplicant feature is not supported with mesh and Wi-Fi uplink. This feature is not supported on OAW-IAP104/105, OAW-IAP175P/175AC, OAW-RAP3WN, and OAW-IAP134/135.

Configuring an OAW-IAP for 802.1X Supplicant Support

To enable 802.1X supplicant support, configure 802.1X authentication parameters on every OAW-IAP using the AOS-W Instant UI or CLI.

In the UI

1. To use PEAP protocol based 802.1X authentication method, complete the following steps:
 - a. In the **Access Points** tab, click the OAW-IAP on which you want to set the variables for 802.1X authentication, and then click the **edit** link.
 - b. In the **Edit Access Point** window, click the **Uplink** tab.
 - c. Under PEAP user, enter user name, password, and retype the password for confirmation. The OAW-IAP user name and password are stored in OAW-IAP flash. When the OAW-IAP boots, the */tmp/ap1xuser* and */tmp/ap1xpassword* files are created based on these two variables.



The default inner authentication protocol for PEAP is MSCHAPV2.

2. To upload server certificates to validate the authentication server credentials, complete the following steps:
 - a. Click **Upload New Certificate**.
 - b. Specify the URL from where you want to upload the certificates and select the type of certificate.
3. Click **OK**.
4. To configure 802.1X authentication on uplink ports of an OAW-IAP, complete the following steps:
 - a. Click **System > Show advanced options > Uplink**.
 - b. Click AP1X.
 - c. Select PEAP or TLS as an authentication type.
 - d. If you want to validate the server credentials using server certificate, select the **Validate Server** check box. Ensure that the server certificates for validating server credentials are uploaded to OAW-IAP database.
 - e. Click **OK**.
5. Reboot the AP.

In the CLI

To set username and password variable used by the PEAP protocol based 802.1X authentication:

```
(Instant AP) # ap1x-peap-user <ap1xuser> <password>
```

To set the PEAP 802.1X authentication type:

```
(Instant AP) (config) # ap1x peap [validate-server]
(Instant AP) (config) # end
(Instant AP) # commit apply
```

To set TLS 802.1X authentication type:

```
(Instant AP) (config) # ap1x tls <tpm|user> [validate-server]
(Instant AP) (config) # end
(Instant AP) # commit apply
```

To upload user or CA certificates for PEAP or TLS authentication:

```
(Instant AP)# copy tftp <addr> <file> ap1x {ca|cert <password>} format pem
```

To download user or server certificates from a TFTP, FTP or web server:

```
(Instant AP)# download ap1x <url> format pem [psk <psk>]  
(Instant AP)# download ap1xca <url> format pem
```

To view the certificate details:

```
(Instant AP)# show ap1xcert
```

To verify the configuration, use any of the following commands:

```
(Instant AP)# show ap1x config  
(Instant AP)# show ap1x debug-logs  
(Instant AP)# show ap1x status
```

Configuring MAC Authentication for a Network Profile

MAC authentication can be used alone or it can be combined with other forms of authentication such as WEP authentication. However, it is recommended that you do not use the MAC-based authentication.

This section describes the following procedures:

- [Configuring MAC Authentication for Wireless Network Profiles on page 178](#)
- [Configuring MAC Authentication for Wired Profiles on page 179](#)

Configuring MAC Authentication for Wireless Network Profiles

You can configure MAC authentication for a wired profile in the AOS-W Instant UI or CLI.

In the AOS-W Instant UI

To enable MAC Authentication for a wireless network:

1. On the **Network** tab, click **New** to create a new network profile or select an existing profile for which you want to enable MAC authentication and click **edit**.
2. In the **Edit <profile-name>** or **New WLAN** window, ensure that all required WLAN and VLAN attributes are defined, and then click **Next**.
3. On the **Security** tab, select **Enabled** from the **MAC authentication** drop-down list, for **Personal** or **Open** security level.
4. Specify the type of authentication server to use.
5. If the internal authentication server is used, perform the following steps to allow MAC address based authentication:
 - a. Click the **Users** link against the **Internal server** field. The **Users** window is displayed.
 - b. Specify the client MAC address as the user name and password.
 - c. Specify the type of the user (employee or guest).
 - d. Click **Add**.
 - e. Repeat the steps to add more users.
 - f. Click **OK**.
6. To allow the OAW-IAP to use a delimiter in the MAC authentication request, specify a character (for example, colon or dash) as a delimiter for the MAC address string. For example, if you specify the colon as a delimiter, MAC addresses in the xx:xx:xx:xx:xx:xx format are used. If the delimiter is not specified, the MAC address in the xxxxxxxxxxxx format is used.
7. To allow the OAW-IAP to use uppercase letters in the MAC address string, set **Uppercase support** to **Enabled**.

8. Configure other parameters as required.
9. Click **Next** to define access rules, and then click **Finish** to apply the changes.

In the CLI

To configure MAC-address based authentication with external server:

```
(Instant AP) (config)# wlan ssid-profile <name>
(Instant AP) (SSID Profile <name>)# type {<Employee> | <Voice>| <Guest>}
(Instant AP) (SSID Profile <name>)# mac-authentication
(Instant AP) (SSID Profile <name>)# mac-authentication-delimiter <delim>
(Instant AP) (SSID Profile <name>)# mac-authentication-upper-case
(Instant AP) (SSID Profile <name>)# external-server
(Instant AP) (SSID Profile <name>)# auth-server <server-name1>
(Instant AP) (SSID Profile <name>)# auth-server <server-name2>
(Instant AP) (SSID Profile <name>)# server-load-balancing
(Instant AP) (SSID Profile <name>)# radius-reauth-interval <minutes>
(Instant AP) (SSID Profile <name>)# end
(Instant AP)# commit apply
```

To add users for MAC authentication based on internal authentication server:

```
(Instant AP) (config)# user <username> [<password>] [portal| radius]
(Instant AP) (config)# end
(Instant AP)# commit apply
```

Configuring MAC Authentication for Wired Profiles

You can configure MAC authentication for a wired profile in the AOS-W Instant UI or CLI.

In the AOS-W Instant UI

To enable MAC authentication for a wired profile:

1. Click the **Wired** link under **More** at the top right corner of the main window. The **Wired** window is displayed.
2. Click **New** under **Wired Networks** to create a new network or select an existing profile for which you want to enable MAC authentication and then click **Edit**.
3. In the **New Wired Network** or the **Edit Wired Network** window, ensure that all the required Wired and VLAN attributes are defined, and then click **Next**.
4. On the **Security** tab, select **Enabled** from the **MAC authentication** drop-down list.
5. Specify the type of authentication server to use.
6. If the internal authentication server is used, perform the following steps to allow MAC address based authentication:
 - a. Click the **Users** link against the **Internal server** field. The **Users** window is displayed.
 - b. Specify the client MAC address as the user name and password.
 - c. Specify the type of the user (employee or guest).
 - d. Click **Add**.
 - e. Repeat the steps to add more users.
 - f. Click **OK**.
7. Configure other parameters as required.
8. Click **Next** to define access rules, and then click **Finish** to apply the changes.

In the CLI

To configure MAC-address based authentication with external server:

```
(Instant AP) (config)# wired-port-profile <name>
(Instant AP) (wired ap profile <name>)# type {<employee> |<guest>}
(Instant AP) (wired ap profile <name>)# mac-authentication
(Instant AP) (wired ap profile <name>)# auth-server <server-1>
(Instant AP) (wired ap profile <name>)# auth-server <server-2>
(Instant AP) (wired ap profile <name>)# server-load-balancing
(Instant AP) (wired ap profile <name>)# radius-reauth-interval <Minutes>
(Instant AP) (wired ap profile <name>)# end
(Instant AP)# commit apply
```

To add users for MAC authentication based on internal authentication server:

```
(Instant AP) (config)# user <username> [<password>] [portal| radius]
(Instant AP) (config)# end
(Instant AP)# commit apply
```

Configuring MAC Authentication with 802.1X Authentication

This section describes the following procedures:

- [Configuring MAC and 802.1X Authentication for a Wireless Network Profile on page 180](#)
- [Configuring MAC and 802.1X Authentication for Wired Profiles on page 181](#)

Configuring MAC and 802.1X Authentication for a Wireless Network Profile

You can configure MAC authentication with 802.1X authentication for wireless network profile using the AOS-W Instant UI or CLI.

In the AOS-W Instant UI

To configure both MAC and 802.1X authentication for a wireless network:

1. On the **Network** tab, click **New** to create a new network profile or select an existing profile for which you want to enable MAC and 802.1X authentication and click **edit**.
2. In the **Edit <profile-name>** or **New WLAN** window, ensure that all required WLAN and VLAN attributes are defined, and then click **Next**.
3. On the **Security** tab, ensure that the required parameters for MAC authentication and 802.1X authentication are configured.
4. Select the **Perform MAC authentication before 802.1X** checkbox to use 802.1X authentication only when the MAC authentication is successful.
5. Select the checkbox **MAC authentication fail-thru** to use 802.1X authentication even when the MAC authentication fails.
6. Click **Next** and then click **Finish** to apply the changes.

In the CLI

To configure both MAC and 802.1X authentication for a wireless network:

```
(Instant AP) (config)# wlan ssid-profile <name>
(Instant AP) (SSID Profile <name>)# type {<Employee> | <Voice>| <Guest>}
(Instant AP) (SSID Profile <name>)# mac-authentication
(Instant AP) (SSID Profile <name>)# l2-auth-failthrough
(Instant AP) (SSID Profile <name>)# auth-server <server-name1>
(Instant AP) (SSID Profile <name>)# radius-reauth-interval <minutes>
(Instant AP) (SSID Profile <name>)# auth-survivability
(Instant AP) (SSID Profile <name>)# exit
(Instant AP) (config)# auth-survivability cache-time-out <hours>
(Instant AP) (config)# end
(Instant AP)# commit apply
```

Configuring MAC and 802.1X Authentication for Wired Profiles

You can configure MAC and 802.1X authentication for a wired profile in the AOS-W Instant UI or CLI.

In the AOS-W Instant UI

To enable MAC and 802.1X authentication for a wired profile:

1. Click the **Wired** link under **More** at the top right corner of the main window. The **Wired** window is displayed.
2. Click **New** under **Wired Networks** to create a new network or select an existing profile for which you want to enable MAC authentication and then click **Edit**.
3. In the **New Wired Network** or the **Edit Wired Network** window, ensure that all the required Wired and VLAN attributes are defined, and then click **Next**.
4. On the **Security** tab, enable the following options:
 - Select **Enabled** from the **MAC authentication** drop-down list.
 - Select **Enabled** from the **802.1X authentication** drop-down list.
 - Select **Enabled** from the **MAC authentication fail-thru** drop-down list.
5. Specify the type of authentication server to use and configure other required parameters. For more information on configuration parameters, see [Configuring Security Settings for a Wired Profile on page 117](#)
6. Click **Next** to define access rules, and then click **Finish** to apply the changes.

In the CLI

To enable MAC and 802.1X authentication for a wired profile:

```
(Instant AP) (config)# wired-port-profile <name>
(Instant AP) (wired ap profile "<name>")# type {<employee> |<guest>}
(Instant AP) (wired ap profile "<name>")# mac-authentication
(Instant AP) (wired ap profile "<name>")# dot1x
(Instant AP) (wired ap profile "<name>")# l2-auth-failthrough
(Instant AP) (wired ap profile "<name>")# auth-server <name>
(Instant AP) (wired ap profile "<name>")# server-load-balancing
(Instant AP) (wired ap profile "<name>")# radius-reauth-interval <Minutes>
(Instant AP) (wired ap profile "<name>")# end
(Instant AP)# commit apply
```

Configuring MAC Authentication with Captive Portal Authentication

The following configuration conditions apply to MAC + captive portal authentication method:

- If the captive portal splash page type is **Internal-Authenticated** or **External-RADIUS Server**, MAC authentication reuses the server configurations.
- If the captive portal splash page type is **Internal-Acknowledged** or **External-Authentication Text** and MAC authentication is enabled, a server configuration page is displayed.

You can configure the MAC authentication with captive portal authentication for a network profile using the AOS-W Instant UI or CLI.

In the AOS-W Instant UI

1. Select an existing wireless or wired profile for which you want to enable MAC with captive portal authentication. Depending on the network profile selected, the **Edit <WLAN-Profile>** or **Edit Wired Network** window is displayed.



To enable MAC authentication with captive portal authentication on a new WLAN SSID or wired profile, click the **Security** tab on the **New WLAN** and **New Wired Network** window.

2. On the **Security** tab, specify the following parameters:
 - a. Select **Enabled** from the **MAC authentication** drop-down list to enable MAC authentication for captive portal users. If the MAC authentication fails, the captive portal authentication role is assigned to the client.
 - b. To enforce MAC authentication, click the **Access** tab and select **Enforce MAC auth only role** checkbox.
3. Click **Next** and then click **Finish** to apply the changes.

In the CLI

To configure MAC authentication with captive portal authentication for a wireless profile:

```
(Instant AP) (config)# wlan ssid-profile <name>
(Instant AP) (SSID Profile <name>)# type <guest>
(Instant AP) (SSID Profile <name>)# mac-authentication
(Instant AP) (SSID Profile <name>)# captive-portal {<type> [exclude-uplink <types>] | external
[Profile <name>] [exclude-uplink <types>]}
(Instant AP) (SSID Profile <name>)# set-role-mac-auth <mac-only>
(Instant AP) (SSID Profile <name>)# end
(Instant AP)# commit apply
```

To configure MAC authentication with captive portal authentication for a wired profile:

```
(Instant AP) (config)# wired-port-profile <name>
(Instant AP) (wired ap profile <name>)# type <guest>
(Instant AP) (wired ap profile <name>)# mac-authentication
(Instant AP) (wired ap profile <name>)# captive-portal <type>
(Instant AP) (wired ap profile <name>)# captive-portal {<type> [exclude-uplink <types>] |
external [Profile <name>] [exclude-uplink <types>]}
(Instant AP) (wired ap profile <name>)# set-role-mac-auth <mac-only>
(Instant AP) (wired ap profile <name>)# end
(Instant AP)# commit apply
```

Configuring WISPr Authentication

AOS-W Instant supports the following smart clients:

- iPass
- Boingo

These smart clients enable client authentication and roaming between hotspots by embedding iPass Generic Interface Specification (GIS) *redirect*, *authentication*, and *logoff* messages within HTML messages that are sent to the OAW-IAP.



WISPr authentication is supported only for the **Internal - Authenticated** and **External - RADIUS Server** captive portal authentication. Select the **Internal - Authenticated** or the **External - RADIUS Server** option from the **Splash page type** drop-down list to configure WISPr authentication for a WLAN profile.

You can configure WISPr authentication using the AOS-W Instant UI or CLI.

In the AOS-W Instant UI

1. Click the **System** link at the top-right corner of the AOS-W Instant main window. The **System** window is displayed.
2. Click **Show advanced options**.

3. Click **WISPr** tab. The **WISPr** tab contents are displayed. The following figure shows the **WISPr** tab contents:

Figure 36 *Configuring WISPr Authentication*



ISO country code:	<input type="text"/>	E.164 country code:	<input type="text"/>
E.164 area code:	<input type="text"/>	SSID/Zone:	<input type="text"/>
Operator name:	<input type="text"/>	Location name:	<input type="text"/>

4. Enter the ISO Country Code for the WISPr Location ID in the **ISO Country Code** text box.
5. Enter the E.164 Area Code for the WISPr Location ID in the **E.164 Area Code** text box.
6. Enter the operator name of the Hotspot in the **Operator Name** text box.
7. Enter the E.164 Country Code for the WISPr Location ID in the **E.164 Country Code** text box.
8. Enter the SSID/Zone section for the WISPr Location ID in the **SSID/Zone** text box.
9. Enter the name of the Hotspot location in the **Location Name** text box. If no name is defined, the name of the OAW-IAP to which the user is associated is used.
10. Click **OK** to apply the changes.

The WISPr RADIUS attributes and configuration parameters are specific to the RADIUS server used by your ISP for the WISPr authentication. Contact your ISP to determine these values. You can find a list of ISO and ITU country and area codes at the ISO and ITU websites (www.iso.org and <http://www.itu.int>).



A Boingo smart client uses a NAS identifier in the format <CarrierID>_<VenueID> for location identification. To support Boingo clients, ensure that you configure the NAS identifier parameter in the Radius server profile for the WISPr server.

In the CLI

```
(Instant AP) (config)# wlan wispr-profile
(Instant AP) (WISPr)# wispr-location-id-ac
(Instant AP) (WISPr)# wispr-location-id-cc
(Instant AP) (WISPr)# wispr-location-id-isocc
(Instant AP) (WISPr)# wispr-location-id-network
(Instant AP) (WISPr)# wispr-location-name-location
(Instant AP) (WISPr)# wispr-location-name-operator-name
(Instant AP) (WISPr)# end
(Instant AP)# commit apply
```

Blacklisting Clients

The client blacklisting denies connection to the blacklisted clients. When a client is blacklisted, it is not allowed to associate with an OAW-IAP in the network. If a client is connected to the network when it is blacklisted, a deauthentication message is sent to force client disconnection.

This section describes the following procedures:

- [Blacklisting Clients Manually on page 184](#)
- [Blacklisting Users Dynamically on page 184](#)

Blacklisting Clients Manually

Manual blacklisting adds the MAC address of a client to the blacklist. These clients are added into a permanent blacklist. These clients are not allowed to connect to the network unless they are removed from the blacklist.

Adding a Client to the Blacklist

You can add a client to the blacklist manually using the AOS-W Instant UI or CLI.

In the AOS-W Instant UI

1. Click the **Security** link from the top right corner of the AOS-W Instant main window.
2. Click the **Blacklisting** tab.
3. Under the **Manual Blacklisting**, click **New**.
4. Enter the MAC address of the client to be blacklisted in the **MAC address to add** text box.



For the blacklisting to take effect on the MAC address, you must enable blacklisting in the SSID profile. For more information, see [Blacklisting on page 103](#).

5. Click **OK**. The **Blacklisted Since** tab displays the time at which the current blacklisting has started for the client.
6. To delete a client from the manual blacklist, select the MAC Address of the client under the **Manual Blacklisting**, and then click **Delete**.

In the CLI

To blacklist a client:

```
(Instant AP) (config)# blacklist-client <MAC-Address>
(Instant AP) (config)# end
(Instant AP)# commit apply
```

To enable blacklisting in the SSID profile:

```
(Instant AP) (config)# wlan ssid-profile <name>
(Instant AP) (SSID Profile <name>)# blacklisting
(Instant AP) (SSID Profile <name>)# end
(Instant AP)# commit apply
```

To view the blacklisted clients:

```
(Instant AP)# show blacklist-client
```

Blacklisted Clients

```
-----
MAC Reason Timestamp Remaining time(sec) AP name
---
00:1c:b3:09:85:15 user-defined 17:21:29 Permanent -
```

Blacklisting Users Dynamically

The clients can be blacklisted dynamically when they exceed the authentication failure threshold or when a blacklisting rule is triggered as part of the authentication process.

Authentication Failure Blacklisting

When a client takes time to authenticate and exceeds the configured failure threshold, it is automatically blacklisted by an OAW-IAP.

Session Firewall Based Blacklisting

In session firewall based blacklisting, an ACL rule is used to enable the option for automation blacklisting. When the ACL rule is triggered, it sends out blacklist information and the client is blacklisted.

Configuring Blacklist Duration

You can set the blacklist duration using the AOS-W Instant UI or CLI.

In the AOS-W Instant UI

To set a blacklist duration:

1. Click the **Security** link from the top right corner of the AOS-W Instant main window.
2. Click the **Blacklisting** tab.
3. Under Dynamic Blacklisting:
4. For **Auth failure blacklist time**, the duration in seconds after which the clients that exceed the authentication failure threshold must be blacklisted.
5. For **PEF rule blacklisted time**, enter the duration in seconds after which the clients can be blacklisted due to an ACL rule trigger.



NOTE

You can configure a maximum number of authentication failures by the clients, after which a client must be blacklisted. For more information on configuring maximum authentication failure attempts, see [Configuring Security Settings for a WLAN SSID Profile on page 98](#)

To enable session firewall based blacklisting, click **New** and navigate to **WLAN Settings > VLAN > Security > Access** window, and enable the **Blacklist** option of the corresponding ACL rule.

In the CLI

To dynamically blacklist clients:

```
(Instant AP) (config)# auth-failure-blacklist-time <seconds>
(Instant AP) (config)# blacklist-time <seconds>
(Instant AP) (config)# end
(Instant AP)# commit apply
```

To enable blacklisting in the SSID profile:

```
(Instant AP) (config)# wlan ssid-profile <name>
(Instant AP) (SSID Profile <name>)# blacklisting
(Instant AP) (SSID Profile <name>)# end
(Instant AP)# commit apply
```

To view the blacklisted clients:

```
(Instant AP)# show blacklist-client config
```

```
Blacklist Time :60
Auth Failure Blacklist Time :60
Manually Blacklisted Clients
-----
MAC Time
--- ----
Dynamically Blacklisted Clients
-----
MAC Reason Timestamp Remaining time(sec) AP IP
-----
Dyn Blacklist Count :0
```

Uploading Certificates

A certificate is a digital file that certifies the identity of the organization or products of the organization. It is also used to establish your credentials for any web transactions. It contains the organization name, a serial number, expiration date, a copy of the certificate-holder's public key, and the digital signature of the certificate-issuing authority so that a recipient can ensure that the certificate is real.

AOS-W Instant supports the following certificate files:

- Authentication server (PEM format)
- Captive portal server (PEM format)—Customized certificate for internal captive portal server.
- CA certificate (PEM or DER format)
- RadSec certificate (PEM or DER format)

This section describes the following procedures:

- [Loading Certificates through AOS-W Instant UI on page 186](#)
- [Loading Certificates through AOS-W Instant CLI on page 186](#)
- [Removing Certificates on page 187](#)
- [Loading Certificates through OmniVista on page 187](#)

Loading Certificates through AOS-W Instant UI

To load a certificate in the AOS-W Instant UI:

1. Click the **Maintenance** link at the top right corner of the AOS-W Instant main window.
2. Click the **Certificates** tab. The **Certificates** tab contents are displayed.
3. To upload a certificate, click **Upload New Certificate**. The **New Certificate** window is displayed.
4. Browse and select the file to upload.
5. Select any of the following types of certificates from the **Certificate type** drop-down list:
 - CA—CA certificate to validate the identity of the client.
 - Auth Server—The authentication server certificate to verify the identity of the server to the client.
 - Captive portal server—Captive portal server certificate to verify the identity of internal captive portal server to the client.
 - RadSec—The RadSec server certificate to verify the identity of the server to the client.
 - RadSec CA—The RadSec CA certificate for mutual authentication between the OAW-IAP clients and the TLS server.
6. Select the certificate format from the **Certificate format** drop-down list.
7. If you have selected **Auth Server**, **Captive portal server**, or **RadSec** as the type of certificate, enter a passphrase in **Passphrase** and retype the passphrase. If the certificate does not include a passphrase, there is no passphrase required.
8. Click **Browse** and select the appropriate certificate file, and click **Upload Certificate**. The **Certificate Successfully Installed** message is displayed..



The OAW-IAP database can have only one authentication server and one captive portal server certificate at any point in time.

Loading Certificates through AOS-W Instant CLI

To upload a CA, server, or captive portal certificate:

```
(Instant AP)# copy tftp <ip-address> <filename> {cpserver cert <password> format {p12|pem}|  
radsec {ca|cert <password>} format pem |system {lxca format {der|pem}| lxcert <password>  
format pem}}
```

To download RadSec certificates:

```
(Instant AP)# download-cert radsec ftp://192.0.2.7 format pem [psk <psk>]  
(Instant AP)# ownload-cert radsecca ftp://192.0.2.7 format pem
```

Removing Certificates

To clear certificate, execute the following command:

```
(Instant AP)# clear-cert {ca|cp|radsec|radsecca|server}
```

Loading Certificates through OmniVista

You can manage certificates using the OmniVista. The AMP directly provisions the certificates and performs basic certificate verification (such as certificate type, format, version, serial number and so on), before accepting the certificate and uploading to an OAW-IAP network. The AMP packages the text of the certificate into an HTTPS message and sends it to the Virtual Controller. After the VC receives this message, it draws the certificate content from the message, converts it to the right format, and saves it on the RADIUS server.

To load a certificate in OmniVista:

1. Navigate to **Device Setup > Certificate** and then click **Add** to add a new certificate. The **Certificate** window is displayed.
2. Enter the certificate **Name**, and click **Choose File** to browse and upload the certificate.

Figure 37 Loading Certificate via OmniVista

The screenshot shows the 'Certificate' configuration window in the OmniVista interface. The window title is 'Certificate'. The navigation bar includes 'Home', 'Groups', 'APs/Devices', 'Clients', 'Reports', 'System', 'Device Setup', and 'AMP Setup'. The 'Device Setup' tab is active, and the 'Certificate' sub-tab is selected. The form contains the following fields and controls:

- Name:** A text input field.
- Certificate File:** A text input field with a 'Choose File' button and the text 'No file chosen'.
- passphrase:** A text input field.
- Confirm passphrase:** A text input field.
- Format:** A dropdown menu with 'DER' selected.
- Type:** A dropdown menu with 'Server Cert' selected.
- Buttons:** 'Add' and 'Cancel' buttons at the bottom.

3. Select the appropriate **Format** that matches the certificate file name. Select **Server Cert** for certificate **Type**, and provide the passphrase if you want to upload a Server certificate. Select either **Intermediate CA** or **Trusted CA** certificate **Type**, if you want to upload a CA certificate.

Figure 38 Server Certificate

The screenshot shows the 'Certificate' configuration page. The navigation tabs at the top are Home, Groups, APs/Devices, Clients, Reports, System, and Device Setup. The sub-navigation tabs are Discover, Add, Communication, Upload Firmware & Files, and Certificate. The form fields are as follows:

- Name: Test1
- Certificate File: Choose File Server.p12
- passphrase: [masked]
- Confirm passphrase: [masked]
- Format: PKCS#12
- Type: Server Cert

Buttons: Add, Cancel

- After you upload the certificate, navigate to **Groups**, click the Instant **Group** and then select **Basic**. The Group name is displayed only if you have entered the **Organization** name in the AOS-W Instant UI. For more information, see [Configuring Organization String on page 310](#) for further information.

Figure 39 Selecting the Group

The screenshot shows the 'Groups' list page. The navigation tabs at the top are Home, Groups, APs/Devices, Clients, Reports, System, Device Setup, AMP Setup, RAPIDS, and VisualRF. The sub-navigation tabs are Discover, Add, Communication, Upload Firmware & Files, and Certificate. The table below shows the list of groups:

Name	SSID	Total Devices	Down	Mismatched	Ignored	Clients	Usage	VPN Sessions	Up/Down Status	Polling Period	Duplicate
Access Points	-	2	0	2	0	0	-	0	5 minutes		
Karthi	-	3	0	3	0	2	-	0	5 minutes		
S2500	-	1	1	0	0	0	-	0	5 minutes		
SA-ethersphere-india	-	38	0	38	0	115	3.17 Mbps	0	5 minutes		
Test	-	3	0	0	0	0	-	0	5 minutes		
Test_2	-	2	0	0	0	1	-	0	5 minutes		

The **Virtual Controller Certificate** section displays the certificates (CA cert and Server).

- Click **Save** to apply the changes only to OmniVista. Click **Save and Apply** to apply the changes to the OAW-IAP.
- To clear the certificate options, click **Revert**.

This chapter describes the procedures for configuring user roles, role assignment, and firewall policies.

- [Firewall Policies on page 189](#)
- [Content Filtering on page 200](#)
- [Configuring User Roles on page 204](#)
- [Configuring Derivation Rules on page 206](#)

Firewall Policies

AOS-W Instant firewall provides identity-based controls to enforce application-layer security, prioritization, traffic forwarding, and network performance policies for wired and wireless networks. Using AOS-W Instant firewall, you can enforce network access policies that define access to the network, areas of the network that users may access, and the performance thresholds of various applications.

AOS-W Instant supports a role-based stateful firewall. AOS-W Instant firewall recognizes flows in a network and keeps track of the state of sessions. Instant firewall manages packets according to the first rule that matches packet. The firewall logs on the OAW-IAPs are generated as syslog messages.

Access Control List Rules

You can use Access Control List (ACL) rules to either permit or deny data packets passing through the OAW-IAP. You can also limit packets or bandwidth available to a set of user roles by defining access rules. By adding custom rules, you can block or allow access based on the service or application, source or destination IP addresses.

You can create access rules to allow or block data packets that match the criteria defined in an access rule. You can create rules for either inbound traffic or outbound traffic. Inbound rules explicitly allow or block the inbound network traffic that matches the criteria in the rule. Outbound rules explicitly allow or block the network traffic that matches the criteria in the rule. For example, you can configure a rule to explicitly block outbound traffic to an IP address through the firewall.

The OAW-IAP clients are associated with user roles, which determine the client's network privileges and the frequency at which clients re-authenticate.

AOS-W Instant supports the following types of ACLs:

- ACLs that permit or deny traffic based on the source IP address of the packet.
- ACLs that permit or deny traffic based on source or destination IP address, source or destination port number.
- ACLs that permit or deny traffic based on network services, application, application categories, web categories, and security ratings.



You can configure up to 128 access control entries in an ACL for a user role.

The maximum configurable universal role is 4096.

Configuring ACL Rules for Network Services

This section describes the procedure for configuring ACLs to control access to network services. For information on:

- Configuring access rules based on application and application categories, see [Configuring ACL Rules for Application and Application Categories on page 274](#).
- Configuring access rules based on web categories and web reputation, see [Configuring Web Policy Enforcement Service on page 277](#).

In the AOS-W Instant UI

To configure ACL rules for a user role:

1. Navigate to **Security > Roles**. The **Roles** tab contents are displayed.
You can also configure access rules for a wired or wireless client through the WLAN wizard (**Network** tab>**WLAN SSID**>**Edit**>**Edit WLAN** > **Access**) or the Wired profile (**More** > **Wired**>**Edit**> **Edit Wired Network**> **Access**) window.
2. Select the role for which you want to configure access rules.
3. In **Access rules** section, click **New** to add a new rule. The **New Rule** window is displayed.
4. Ensure that the rule type is set to **Access Control**
5. To configure a rule to control access to network services, select **Network** under service category and specify the following parameters:

Table 37: Access Rule Configuration Parameters

Service Category	Description
Network	<p>Select a service from the list of available services. You can allow or deny access to any or all of the following services based on your requirement:</p> <ul style="list-style-type: none"> • any—Access is allowed or denied to all services. • custom—Available options are TCP, UDP, and Other. If you select the TCP or UDP options, enter appropriate port numbers. If you select the Other option, enter the appropriate ID. <p>NOTE: If TCP and UDP uses the same port, ensure that you configure separate access rules to permit or deny access.</p>
Action	<p>Select any of following actions:</p> <ul style="list-style-type: none"> • Select Allow to allow access users based on the access rule. • Select Deny to deny access to users based on the access rule. • Select Destination-NAT to allow changes to destination IP address. • Select Source-NAT to allow changes to the source IP address.
Destination	<p>Select a destination option for the access rules for network services, applications, and application categories. You can allow or deny access to any the following destinations based on your requirements.</p> <ul style="list-style-type: none"> • to all destinations— Access is allowed or denied to all destinations. • to a particular server—Access is allowed or denied to a particular server. After selecting this option, specify the IP address of the destination server. • except to a particular server—Access is allowed or denied to servers other than the specified server. After selecting this option, specify the IP address of the destination server. • to a network—Access is allowed or denied to a network. After selecting this option,

Table 37: Access Rule Configuration Parameters

Service Category	Description
	<p>specify the IP address and netmask for the destination network.</p> <ul style="list-style-type: none"> ● except to a network—Access is allowed or denied to networks other than the specified network. After selecting this option, specify the IP address and netmask of the destination network. ● to domain name—Access is allowed or denied to the specified domains. After selecting this option, specify the domain name in the Domain Name text box.
Log	Select this checkbox if you want a log entry to be created when this rule is triggered. AOS-W Instant supports firewall based logging. Firewall logs on the OAW-IAPs are generated as security logs.
Blacklist	Select the Blacklist checkbox to blacklist the client when this rule is triggered. The blacklisting lasts for the duration specified as Auth failure blacklist time on the Blacklisting tab of the Security window. For more information, see Blacklisting Clients on page 183 .
Classify media	Select the Classify media checkbox to prioritize video and voice traffic. When enabled, a packet inspection is performed on all non-NAT traffic and the traffic is marked as follows: <ul style="list-style-type: none"> ● Video: Priority 5 (Critical) ● Voice: Priority 6 (Internetwork Control)
Disable scanning	Select Disable scanning checkbox to disable ARM scanning when this rule is triggered. The selection of the Disable scanning applies only if ARM scanning is enabled, For more information, see Configuring Radio Settings on page 264 .
DSCP tag	Select the DSCP tag checkbox to specify a DSCP value to prioritize traffic when this rule is triggered. Specify a value within the range of 0 to 63. To assign a higher priority, specify a higher value.
802.1p priority	Select the 802.1p priority checkbox to specify an 802.1p priority. Specify a value between 0 and 7. To assign a higher priority, specify a higher value.

6. Click **OK** and then click **Finish**.

In the CLI

To configure access rules:

```
(Instant AP) (config)# wlan access-rule <access-rule-name>
(Instant AP) (Access Rule <Name>)#rule <dest> <mask> <match/invert> {<protocol> <start-port>
<end-port> {permit|deny|src-nat|dst-nat{<IP-address> <port>| <port>}}[<option1....option9>]
(Instant AP) (Access Rule <Name>)# end
(Instant AP)# commit apply
```

Example

```
(Instant AP) (config)# wlan access-rule employee
(Instant AP) (Access Rule "employee")# rule 10.17.88.59 255.255.255.255 match 6 4343 4343 log
classify-media
(Instant AP) (Access Rule "employee")# rule 192.0.2.8 255.255.255.255 invert 6 110 110 permit
(Instant AP) (Access Rule "employee")# rule 192.0.2.2 255.255.255.0 192.0.2.7 255.255.255.0
match tcp 21 21 deny
```

```
(Instant AP) (Access Rule "employee")# rule 192.0.2.2 255.255.255.0 192.0.2.7 255.255.255.0
match udp 21 21 deny
(Instant AP) (Access Rule "employee")# rule 192.0.2.2 255.255.255.0 match 6 631 631 permit
(Instant AP) (Access Rule "employee")# rule 192.0.2.8 255.255.255.255 invert 6 21 21 deny
(Instant AP) (Access Rule "employee")# rule 192.0.2.1 255.255.255.0 invert 17 67 69 deny
(Instant AP) (Access Rule "employee")# end
(Instant AP)# commit apply
```

Configuring Network Address Translation Rules

Network Address Translation (NAT) is the process of modifying network address information when packets pass through a routing device. The routing device acts as an agent between the public (the Internet) and private (local network), which allows translation of private network IP addresses to a public address space.

AOS-W Instant supports the NAT mechanism to allow a routing device to use the translation tables to map the private addresses into a single IP address and packets are sent from this address, so that they appear to originate from the routing device. Similarly, if the packets are sent to the private IP address, the destination address is translated as per the information stored in the translation tables of the routing device.

Configuring a Source NAT Access Rule

The source NAT action in access rules allows the user to override the routing profile entries. For example, when a routing profile is configured to use 0.0.0.0/0, the client traffic in L3 mode access on an SSID destined to the corporate network is sent to the tunnel. When an access rule is configured with **Source NAT** action, the users can specify the service, protocol, or destination to which the source NAT is applied.

You can also configure source based routing to allow client traffic on one SSID to reach the Internet through the corporate network, while the other SSID can be used as an alternate uplink. You can create an access rule to perform source NAT by using the AOS-W Instant UI or CLI.

In the AOS-W Instant UI

To configure a source NAT access rule:

1. Navigate to the WLAN wizard or Wired settings window:
 - To configure access rules for a WLAN SSID, in the **Network** tab, click **New** to create a new network profile or **edit** to modify an existing profile.
 - To configure access rules for a wired profile, **More > Wired**. In the **Wired** window, click **New** under **Wired Networks** to create a new network or click **Edit** to select an existing profile.
2. Click the **Access** tab.
3. To configure access rules for the network, slide to **Network-based**. To configure access rules for user roles, slide to **Role-based**.
4. To create a new rule for the network, click **New**. To create an access rule for a user role, select the user role and then click **New**. The **New Rule** window is displayed.
5. In the **New Rule** window, perform the following steps:
 - a. Select **Access control** from the **Rule type** drop-down list.
 - b. Select **Source-NAT** from the **Action** drop-down list, to allow changes to the source IP address.
 - c. Select a service from the list of available services.
 - d. Select the required option from the **Destination** drop-down list.
 - e. If required, enable other parameters such as **Log**, **Blacklist**, **Classify media**, **Disable scanning**, **DSCP tag**, and **802.1p priority**.
 - f. Click **OK**.
6. Click **Finish**.

In the CLI

To configure source NAT access rule:

```
(Instant AP) (config)# wlan access-rule <access_rule>
(Instant AP) (Access Rule "<access_rule>")# rule <dest> <mask> <match> <protocol> <sport>
<eport> src-nat
(Instant AP) (Access Rule "<access_rule>")# end
(Instant AP)# commit apply
```

Configuring Source-Based Routing

To allow different forwarding policies for different SSIDs, you can configure source-based routing. The source-based routing configuration overrides the routing profile configuration and allows any destination or service to be configured to have direct access to the Internet (bypassing VPN tunnel) based on the ACL rule definition. When source-based routing is enabled, the Virtual Controller performs source NAT by using its uplink IP address.

To configure source-based routing:

1. Ensure that an L3 subnet with the netmask, gateway, VLAN, and IP address is configured. For more information on configuring L3 subnet, see [Configuring L3-Mobility on page 343](#).
2. Ensure that the source IP address is associated with the IP address configured for the L3 subnet.
3. Create an access rule for the SSID profile with Source NAT action as described in [Configuring Source-Based Routing on page 193](#). The source NAT pool is configured and source based routing entry is created.

Configuring a Destination NAT Access Rule

Instant supports configuration of the destination NAT rule, which can be used to redirect traffic to the specified IP address and destination port. Destination-NAT configuration is supported only in the bridge mode without VPN.

You can configure a destination-NAT access rule by using the AOS-W Instant UI or CLI.

In the AOS-W Instant UI

To configure a destination NAT access rule:

1. Navigate to the WLAN wizard or Wired settings window:
 - To configure access rules for a WLAN SSID, in the **Network** tab, click **New** to create a new network profile or **edit** to modify an existing profile.
 - To configure access rules for a wired profile, **More > Wired**. In the **Wired** window, click **New** under **Wired Networks** to create a new network or click **Edit** to select an existing profile.
2. Click the **Access** tab and perform any of the following steps:
 - To configure access rules for the network, slide to **Network-based**.
 - To configure access rules for user roles, slide to **Role-based**.
3. To create a new rule for the network, click **New**. To create an access rule for a user role, select the user role and then click **New**. The **New Rule** window is displayed.
4. In the **New Rule** window, perform the following steps:
 - a. Select **Access control** from the **Rule type** drop-down list.
 - b. Select **destination-NAT** from the **Action** drop-down list, to allow changes to the source IP address.
 - c. Specify the IP address and port details.
 - d. Select a service from the list of available services.
 - e. Select the required option from the **Destination** drop-down list.

- f. If required, enable other parameters such as **Log**, **Blacklist**, **Classify media**, **Disable scanning**, **DSCP tag**, and **802.1p priority**.
 - g. Click **OK**.
5. Click **Finish**.

In the CLI

To configure destination NAT access rule:

```
(Instant AP) (config)# wlan access-rule <access_rule>
(Instant AP) (Access Rule "<access_rule>")# rule <dest> <mask> <match> <protocol> <sport>
<eport> dst-nat ip <IP-address> [<port>]
(Instant AP) (Access Rule "<access_rule>")# end
(Instant AP)# commit apply
```

Configuring ALG Protocols

You can enable or disable protocols for Application Layer Gateway (ALG) using the AOS-W Instant UI or CLI.

In the AOS-W Instant UI

To enable or disable ALG protocols:

1. Click the **Security** link at the top right corner of AOS-W Instant main window.
2. Click the **Firewall Settings** tab. The **Firewall Settings** tab contents are displayed. The following figure shows the contents of the **Firewall Settings** tab:

Figure 40 Firewall Settings—ALG Protocols

Application Layer Gateway (ALG) Algorithms	Protection against wired attacks
SIP: <input type="text" value="Enabled"/>	Drop bad ARP: <input type="text" value="Disabled"/>
Vocera: <input type="text" value="Enabled"/>	Fix malformed DHCP: <input type="text" value="Disabled"/>
Alcatel NOE: <input type="text" value="Enabled"/>	ARP poison check: <input type="text" value="Disabled"/>
Cisco Skinny: <input type="text" value="Disabled"/>	

3. Select **Enabled** from the corresponding drop-down lists to enable SIP, VOCERA, Alcatel NOE, and Cisco skinny protocols.
4. Click **OK**.



When the protocols for ALG are set to **Disabled**, the changes are not applied until the existing user sessions expire. Reboot the OAW-IAP and the client, or wait for a few minutes to view the changes.

In the CLI

To configure protocols for ALG:

```
(Instant AP) (config)# alg
(Instant AP) (ALG)# sccp-disable
(Instant AP) (ALG)# no sip-disable
(Instant AP) (ALG)# no ua-disable
(Instant AP) (ALG)# no vocera-disable
(Instant AP) (ALG)# end
(Instant AP)# commit apply
```

To view the ALG configuration:

```
(Instant AP) # show alg
```

```
Current ALG
-----
ALG Status
-----
sccp Disabled
sip Enabled
ua Enabled
vocera Enabled
```

Configuring Firewall Settings for Protection from ARP Attacks

You can configure firewall settings to protect the network against attacks using the AOS-W Instant UI or CLI.

In the AOS-W Instant UI

To configure firewall settings:

1. Click the **Security** link at the top right corner of AOS-W Instant main window.
2. Click the **Firewall Settings** tab. The **Firewall Settings** tab contents are displayed.
3. To configure protection against security attacks, select the following checkboxes:
 - Select **Drop bad ARP** to enable the OAW-IAP to drop the fake ARP packets.
 - Select **Fix malformed DHCP** to the OAW-IAP to fix the malformed DHCP packets.
 - Select **ARP poison check** to enable the OAW-IAP to trigger an alert notifying the user about the ARP poisoning that may have been caused by the rogue APs.

Figure 41 Firewall Settings —Protection Against Wired Attacks

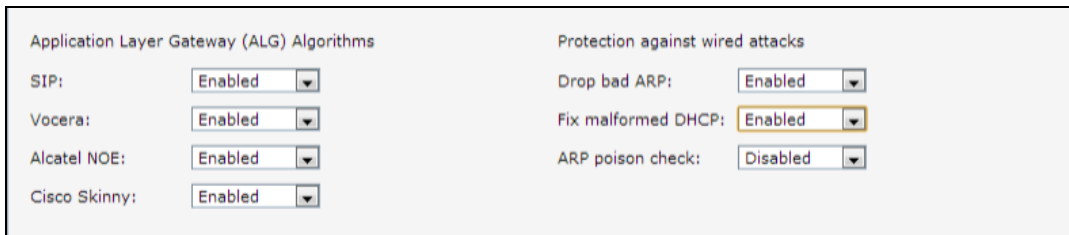

The screenshot shows a configuration window for 'Application Layer Gateway (ALG) Algorithms' and 'Protection against wired attacks'. The 'Protection against wired attacks' section has three dropdown menus: 'Drop bad ARP' (Enabled), 'Fix malformed DHCP' (Enabled), and 'ARP poison check' (Disabled). The 'Fix malformed DHCP' dropdown is highlighted with a yellow border.

Application Layer Gateway (ALG) Algorithms	Protection against wired attacks
SIP: Enabled	Drop bad ARP: Enabled
Vocera: Enabled	Fix malformed DHCP: Enabled
Alcatel NOE: Enabled	ARP poison check: Disabled
Cisco Skinny: Enabled	

4. Click **OK**.

In the CLI

To configure firewall settings to prevent attacks

```
(Instant AP) (config) # attack
(Instant AP) (ATTACK) # drop-bad-arp-enable
(Instant AP) (ATTACK) # fix-dhcp-enable
(Instant AP) (ATTACK) # poison-check-enable
(Instant AP) (ATTACK) # end
(Instant AP) # commit apply
```

To view the configuration status:

```
(Instant AP) # show attack config
```

```
Current Attack
-----
Attack Status
-----
drop-bad-arp Enabled
fix-dhcp Enabled
poison-check Enabled
```

To view the attack statistics

```
(Instant AP)# show attack stats

attack counters
-----
Counter Value
-----
arp packet counter 0
drop bad arp packet counter 0
dhcp response packet counter 0
fixed bad dhcp packet counter 0
send arp attack alert counter 0
send dhcp attack alert counter 0
arp poison check counter 0
garp send check counter 0
```

Managing Inbound Traffic

AOS-W Instant now supports an enhanced inbound firewall by allowing the configuration of firewall rules and management subnets, and restricting corporate access through an uplink switch.

To allow flexibility in firewall configuration, AOS-W Instant supports the following features:

- Inbound firewall rules
- Configurable management subnets
- Restricted corporate access

Configuring Inbound Firewall Rules

You can now configure firewall rules for the inbound traffic coming through the uplink ports of an OAW-IAP. The rules defined for the inbound traffic are applied if the destination is not a user connected to the OAW-IAP. If the destination already has a user role assigned, the user role overrides the actions or options specified in inbound firewall configuration. However, if a deny rule is defined for the inbound traffic, it is applied irrespective of the destination and user role. Unlike the ACL rules in a WLAN SSID or wired profile, the inbound firewall rules can be configured based on the source subnet.

For all subnets, a deny rule is created by default as the last rule. If at least one rule is configured, the deny all rule is applied to the upstream traffic by default.



Management access to the AP is allowed irrespective of the inbound firewall rule. For more information on configuring restricted management access, see [Configuring Management Subnets on page 199](#).

The inbound firewall is not applied to traffic coming through GRE tunnel.

You can configure inbound firewall rules through the AOS-W Instant UI or CLI.

In the AOS-W Instant UI

1. Navigate to **Security > Inbound Firewall** tab. The **Inbound Firewall** tab contents are displayed.
2. Under **Inbound Firewall Rules**, click **New**. The **New Rule** window is displayed.

Figure 42 *Inbound Firewall Rules - New Rule Window*

3. Configure the following parameters:

Table 38: *Inbound Firewall Rule Configuration Parameters*

Parameter	Description
Action	<p>Select any of following actions:</p> <ul style="list-style-type: none"> • Select Allow to allow access users based on the access rule. • Select Deny to deny access to users based on the access rule. • Select Destination-NAT to allow changes to destination IP address. • Select Source-NAT to allow changes to the source IP address. <p>The destination-nat and source-nat actions apply only to the network services rules.</p>
Service	<p>Select a service from the list of available services. You can allow or deny access to any or all of the following services based on your requirement:</p> <ul style="list-style-type: none"> • any—Access is allowed or denied to all services. • custom—Available options are TCP, UDP, and Other. If you select the TCP or UDP options, enter appropriate port numbers. If the Other option is selected, ensure enter the appropriate ID is entered.
Source	<p>Select any of the following options:</p> <ul style="list-style-type: none"> • from all sources— Traffic from all sources is either allowed, denied, or the IP address is translated at the source or destination as defined in the rule. • from a host—Traffic from a particular host is either allowed, denied, or the IP address is translated at the source or destination as defined in the rule. After selecting this option, specify the IP address of the host. • from a network—Traffic from a particular network is either allowed, denied, or the IP address is translated at the source or destination as defined in the rule. After selecting this option, specify the IP address and netmask of the source network.
Destination	<p>Select a destination option for the access rules for network services, applications, and application categories. You can allow or deny access to any the following destinations based on your requirements.</p> <ul style="list-style-type: none"> • to all destinations— Traffic for all destinations is allowed, denied, or the IP address is translated at the source or destination as defined in the rule. • to a particular server—Traffic to a specific server is allowed, denied, or the IP address is translated at the source or destination as defined in the rule. After selecting this option, specify the IP address of the destination server. • except to a particular server—Access is allowed or denied to servers other than the specified server. After selecting this option, specify the IP address of the destination

Table 38: Inbound Firewall Rule Configuration Parameters

Parameter	Description
	<p>server.</p> <ul style="list-style-type: none"> ● to a network—Traffic to the specified network is allowed, denied, or the IP address is translated at the source or destination as defined in the rule. After selecting this option, specify the IP address and netmask for the destination network. ● except to a network—Access is allowed or denied to networks other than the specified network. After selecting this option, specify the IP address and netmask of the destination network. ● to domain name—Traffic to the specified domain is allowed, denied, or the IP address is translated at the source or destination as defined in the rule. After selecting this option, specify the domain name in the Domain Name text box.
Log	Select this checkbox if you want a log entry to be created when this rule is triggered. AOS-W Instant supports firewall based logging function. Firewall logs on the OAW-IAPs are generated as security logs.
Blacklist	Select the Blacklist checkbox to blacklist the client when this rule is triggered. The blacklisting lasts for the duration specified as Auth failure blacklist time on the Blacklisting tab of the Security window. For more information, see Blacklisting Clients on page 183 .
Classify media	Select the Classify media checkbox to prioritize video and voice traffic. When enabled, a packet inspection is performed on all non-NAT traffic and the traffic is marked as follows: <ul style="list-style-type: none"> ● Video: Priority 5 (Critical) ● Voice: Priority 6 (Internetnetwork Control)
Disable scanning	Select Disable scanning checkbox to disable ARM scanning when this rule is triggered. The selection of the Disable scanning applies only if ARM scanning is enabled, For more information, see Configuring Radio Settings on page 264 .
DSCP tag	Select the DSCP tag checkbox to specify a DSCP value to prioritize traffic when this rule is triggered. Specify a value within the range of 0 to 63. To assign a higher priority, specify a higher value.
802.1p priority	Select the 802.1p priority checkbox to specify an 802.1p priority. Specify a value between 0 and 7. To assign a higher priority, specify a higher value.

4. Click **OK** and then click **Finish**.

In the CLI

To configure inbound firewall rules:

```
(Instant AP) (config)# inbound-firewall
(Instant AP) (inbound-firewall)# rule <subnet> <smask> <dest> <mask> <protocol> <sport> <eport>
{permit|deny|src-nat|dst-nat <IP-address> <port>} [<option1....option9>]
(Instant AP) (inbound-firewall)# end
(Instant AP)# commit apply
```

Example

```
(Instant AP) (config)# inbound-firewall
(Instant AP) (inbound-firewall)# rule 192.0.2.1 255.255.255.255 any any match 6 631 631 permit
```

```
(Instant AP) (inbound-firewall) # end
(Instant AP) # commit apply
```

Configuring Management Subnets

You can configure subnets to ensure that the OAW-IAP management is carried out only from these subnets. When the management subnets are configured, Telnet, SSH, and UI access is restricted to these subnets only.

You can configure management subnets by using the AOS-W Instant UI or CLI.

In the AOS-W Instant UI

To configure management subnets:

1. Navigate to **Security > Inbound Firewall**. The **Inbound Firewall** tab contents are displayed.

Figure 43 Firewall Settings—Management Subnets

The screenshot displays the 'Inbound Firewall Configuration' page. At the top, there is a section for 'Inbound Firewall Rules' with a table and buttons for 'New', 'Edit', 'Delete', and arrows. Below this is the 'Inbound Firewall Configuration' section. On the left, there is a table titled 'Management Subnets' with columns 'Subnet' and 'Mask'. Below the table are 'Delete' and 'Delete All' buttons. On the right, there is a section for 'Add new management subnet' with input fields for 'Subnet' and 'Mask', and an 'Add' button. At the bottom right, there is a dropdown menu for 'Restrict Corporate Access' set to 'Disabled'.

2. To add a new management subnet:
 - Enter the subnet address in **Subnet**.
 - Enter the subnet mask in **Mask**.
 - Click **Add**.
3. To add multiple subnets, repeat step 2.
4. Click **OK**.

In the CLI

To configure a management subnet:

```
(Instant AP) (config) # restricted-mgmt-access <subnet-IP-address> <subnet-mask>
(Instant AP) (config) # end
(Instant AP) # commit apply
```

Configuring Restricted Access to Corporate Network

You can configure restricted corporate access to block unauthorized users from accessing the corporate network. When restricted corporate access is enabled, corporate access is blocked from the uplink port of master OAW-IAP, including clients connected to a slave OAW-IAP. You can configure restricted corporate access by using the AOS-W Instant UI or CLI.

In the AOS-W Instant UI

To configure restricted corporate access:

1. Navigate to **Security > Inbound Firewall**. The **Inbound Firewall** (see [Figure 43](#)) tab contents are displayed.

2. Select **Enabled** from the **Restrict Corporate Access**.
3. Click **OK**.

In the CLI

To configure restricted management access:

```
(Instant AP) (config) # restrict-corp-access
(Instant AP) (config) # end
(Instant AP) # commit apply
```

Content Filtering

The content filtering feature allows you to route DNS request to the OpenDNS platform and create content filtering policies.

With content filter, you can:

- Allow all DNS requests to the non-corporate domains on a wireless or wired network to be sent to the open DNS server. When the OpenDNS credentials are configured, the OAW-IAP uses these credentials to access OpenDNS to provide enterprise-level content filtering. For more information, see [Configuring OpenDNS Credentials on page 296](#)
- Block certain categories of websites based on your organization policy. For example, if you block the **web-based-email** category, clients who are assigned this policy will not be able to visit email-based websites such as mail.yahoo.com.
- Prevent known malware hosts from accessing your wireless network.
- Improve employee productivity by limiting access to certain websites.
- Reduce bandwidth consumption significantly.



Regardless of whether content filtering is disabled or enabled, the DNS requests to <http://instant.alcatel-lucentnetworks.com> are always resolved internally on AOS-W Instant.

The content filtering configuration applies to all OAW-IAPs in the network and the service is enabled or disabled globally across the wireless or wired network profiles.

Enabling Content Filtering

This section describes the following procedures:

- [Enabling Content Filtering for a Wireless Profile on page 200](#)
- [Enabling Content Filtering for a Wired Profile](#)

Enabling Content Filtering for a Wireless Profile

To enable content filtering for a wireless SSID, perform the following steps:

In the AOS-W Instant UI

1. Select a wireless profile in the **Networks** tab and then click the **edit** link. The window for editing the WLAN SSID profile is displayed.
2. Click **Show advanced options**.
3. Select **Enabled** from the **Content Filtering** drop-down list, and click **Next** to continue.

You can also enable content filtering while adding a new wireless profile. For more information, see [Configuring WLAN Settings for an SSID Profile on page 91](#).

In the CLI

To enable content filtering on a WLAN SSID:

```
(Instant AP) (config)# wlan ssid-profile <name>
(Instant AP) (SSID Profile <name>)# content-filtering
(Instant AP) (SSID Profile <name>)# end
(Instant AP)# commit apply
```

Enabling Content Filtering for a Wired Profile

To enable content filtering for a wired profile, perform the following steps:

In the AOS-W Instant UI

1. Click the **Wired** link under **More** at the top right corner of the main window. The **Wired** window is displayed.
2. In the **Wired** window, select the wired profile to modify.
3. Click **Edit**. The **Edit Wired Network** window is displayed.
4. In the **Wired Settings** tab, select **Enabled** from the **Content Filtering** drop-down list and click **Next** to continue.

In the CLI

To enable content filtering for a wired profile in the CLI:

```
(Instant AP) (config)# wired-port-profile test
(Instant AP) (wired ap profile <name>)# content-filtering
(Instant AP) (wired ap profile <name>)# end
(Instant AP)# commit apply
```

Configuring Enterprise Domains

The enterprise domain names list displays the DNS domain names that are valid on the enterprise network. This list is used to determine how client DNS requests must be routed. When **Content Filtering** is enabled, the DNS request of the clients is verified and the domain names that do not match the names in the list are sent to the open DNS server.

You can configure an enterprise domain through the AOS-W Instant UI or CLI.

In the AOS-W Instant UI

To manually add a domain:

1. Navigate to **System > General**, click **Show advanced options > Enterprise Domains**. The **Enterprise Domain** tab contents are displayed.
2. Click **New** and enter a **New Domain Name**. Using "*" as an enterprise domain causes all DNS traffic to go through the tunnel to the original DNS server of clients. If you are configuring routing profile with split-tunnel disabled, you need add "*" to the enterprise domain list.
3. Click **OK** to apply the changes.

To delete a domain, select the domain and click **Delete** to remove the domain name from the list.

In the CLI

To configure an enterprise domain:

```
(Instant AP) (config)# internal-domains
(Instant AP) (domain)# domain-name <name>
(Instant AP) (domain)# end
(Instant AP)# commit apply
```

Configuring URL Filtering Policies

You can configure URL filtering policies to block certain categories of websites based on your organization specifications by defining ACL rules either through the AOS-W Instant UI or CLI.

In the AOS-W Instant UI

1. Navigate to **Security > Roles**.
2. Select any WLAN SSID or wired profile role, and click **New** in the Access Rules section. The **New Rule window** appears.
3. Select the rule type as **Access Control**.
4. To set an access policy based on the web category:
 - a. Under **Services**, select **Web category** and expand the **Web categories** drop-down.

Figure 44

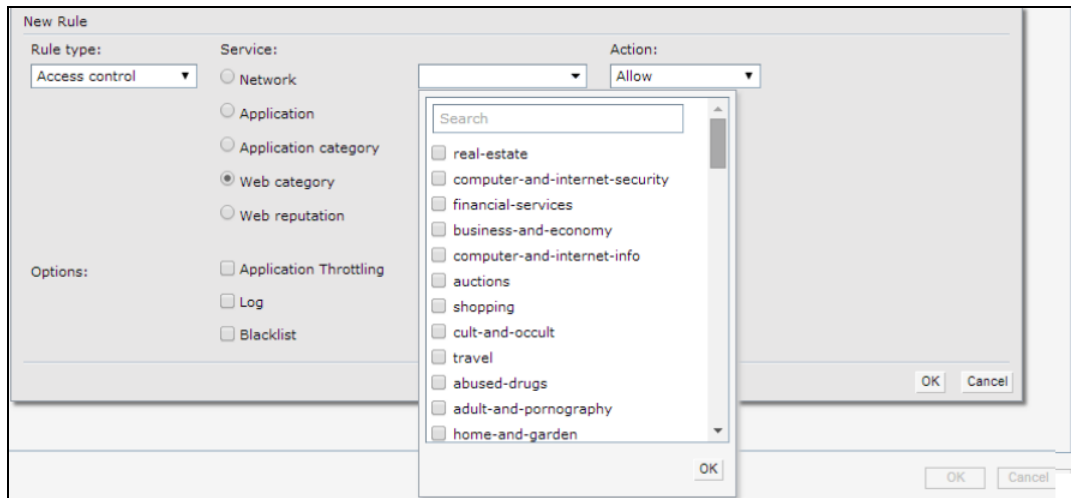

- b. Select the categories to which you want to deny or allow access. You can also search for a web category and select the required option.
 - c. From the **Action** drop-down, select **Allow** or **Deny** as required.
 - d. Click **OK**.
5. To filter access based on the security ratings of the website:
 - a. Select **Web reputation** under **Services**.
 - b. Move the slider to the required security rating level.
 - c. From the **Action** drop-down, select **Allow** or **Deny** as required.
 6. To set a bandwidth limit based on web category or web reputation score, select **Application Throttling** checkbox and specify the downstream and upstream rates in Kbps. For example, you can set a higher bandwidth for trusted sites and a low bandwidth rate for high risk sites.
 7. Click **OK** to save the rules.
 8. Click **OK** in the **Roles** tab to save the changes to the role for which you defined ACL rules.

In the CLI

To control access based on web categories and security ratings:

```
(Instant AP) (config)# wlan access-rule <access_rule>
(Instant AP) (Access Rule "<access-rule>")# rule <dest> <mask> <match> webcategory <webgrp>
{permit| deny} [<option1...option9>]
(Instant AP) (Access Rule "<access-rule>")# rule <dest> <mask> <match> webreputation <webrep>
{permit|deny} [<option1...option9>]
(Instant AP) (Access Rule "<access-rule>")# end
```

```
(Instant AP)# commit apply
```

Example

```
(Instant AP) (config)# wlan access-rule URLFilter
(Instant AP) (Access Rule "URLFilter")# rule any any match webcategory gambling deny
(Instant AP) (Access Rule "URLFilter")# rule any any match webcategory training-and-tools
permit
(Instant AP) (Access Rule "URLFilter")# rule any any match webreputation trustworthy-sites
permit
(Instant AP) (Access Rule "URLFilter")# rule any any match webreputation suspicious-sites deny
(Instant AP) (Access Rule "URLFilter")# end
(Instant AP)# commit apply
```

Creating Custom Error Page for Web Access Blocked by AppRF Policies

You can create a list of URLs to redirect users to when they access blocked websites. You can define an access rule to use these redirect URLs and assign the rule to a user role in the WLAN network.

You can create a list of custom URLs and ACL rules for blocked websites either through the AOS-W Instant UI or CLI.

Creating a List of Error Page URLs

To create a list of error page URLs:

In the AOS-W Instant UI

1. Navigate to **Security >Custom Blocked Page URL**.
2. Click **New** and enter the URL to block.
3. Repeat the procedure to add more URLs. You can add up to 8 URLs to the blocked page list.
4. Click **OK**.

In the CLI

```
(Instant AP) (config)# dpi-error-page-url <idx> <url>
(Instant AP) (config)# exit
(Instant AP)# commit apply
```

Configuring ACL Rules to Redirect Users to a Specific URL

To configure ACL rules to redirect users to a specific URL:

In the UI

1. Navigate to **Security >Roles**.
2. Select any WLAN SSID or wired profile role, and click **New** in the Access Rules section. The **New Rule window** appears.
3. Select the rule type as **Blocked Page URL**.
4. Select the URLs from the existing list of custom redirect URLs. To add a new URL, click **New**.
5. Click **OK**.
6. Click **OK** in the **Roles** tab to save the changes.

In the CLI

To configure an ACL rule to redirect users to a specific URL:

```
(Instant AP) (config)# wlan access-rule <url_filter>
(Instant AP) (Access Rule "<url_filter>")# dpi-error-page-url <idx>
(Instant AP) (Access Rule "<url_filter>")# end
(Instant AP)# commit apply
```

Configuring User Roles

Every client in the AOS-W Instant network is associated with a user role that determines the network privileges for a client, the frequency of reauthentication, and the applicable bandwidth contracts.



AOS-W Instant allows you to configuration of up to 32 user roles. If the number of roles exceed 32, an error message is displayed.

The user role configuration on an OAW-IAP involves the following procedures:

- [Creating a User Role on page 204](#)
- [Assigning Bandwidth Contracts to User Roles on page 204](#)
- [Configuring Machine and User Authentication Roles on page 205](#)

Creating a User Role

You can create a user role by using the AOS-W Instant UI or CLI.

In the AOS-W Instant UI

To create a user role:

1. Click the **Security** at the top right corner of AOS-W Instant main window. The **Security** window is displayed.
2. Click **Roles** tab. The Roles tab contents are displayed.
3. Under Roles, click **New**.
4. Enter a name for the new role and click **OK**.



You can configure a maximum of upto 32 user roles on an OAW-IAP.



You can also create a user role when configuring wireless or wired network profiles. For more information, see [Configuring Access Rules for a WLAN SSID Profile on page 105](#) and [Configuring Access Rules for a Wired Profile on page 118](#)

In the CLI

To configure user roles and access rules:

```
(Instant AP) (config)# wlan access-rule <access-rule-name>
(Instant AP) (Access Rule <Name>)# rule <dest> <mask> <match> <protocol> <start-port> <end-port> {permit |deny | src-nat | dst-nat {<IP-address> <port> | <port>}} [<option1...option9>]
```

Assigning Bandwidth Contracts to User Roles

The administrators can manage bandwidth utilization by assigning maximum bandwidth rates, or bandwidth contracts to user roles. The administrator can assign a bandwidth contract configured in Kbps to upstream (client to the OAW-IAP) or downstream (OAW-IAP to clients) traffic for a user role. The bandwidth contract will not be applicable to the user traffic on the bridged out (same subnet) destinations. For example, if clients are connected to an SSID, you can restrict the upstream bandwidth rate allowed for each user to 512 Kbps.

By default, all users that belong to the same role share a configured bandwidth rate for upstream or downstream traffic. The assigned bandwidth will be served and shared among all the users. You can also assign bandwidth per user to provide every user a specific bandwidth within a range of 1 to 65535 Kbps. If there is no bandwidth contract specified for a traffic direction, unlimited bandwidth is allowed.



In the earlier releases, bandwidth contract could be assigned per SSID. In the current release, the bandwidth

contract can also be assigned for each SSID user. If the bandwidth contract is assigned for an SSID in the AOS-W Instant 6.2.1.0-3.4.0.0 image, and when the OAW-IAP is upgraded to 6.4.4.4-4.2.3.0 release version, the bandwidth configuration per SSID will be treated as a per-user downstream bandwidth contract for that SSID.

In the AOS-W Instant UI

1. Click the **Security** at the top right corner of AOS-W Instant main window. The **Security** window is displayed.
2. Click the **Roles** tab. The **Roles** tab contents are displayed.
3. [Create a new role](#) or select an existing role.
4. Under **Access Rules**, click **New**. The **New Rule** window is displayed.
5. Select **Bandwidth Contract** from the **Rule Type** drop-down list.

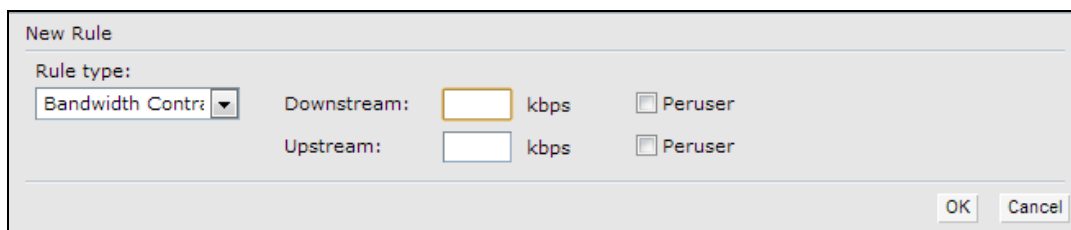

6. Specify the downstream and upstream rates in Kbps. If the assignment is specific for each user, select the **Peruser** checkbox.
7. Click **OK**.
8. Associate the user role to a WLAN SSID or wired profile.

You can also create a user role and assign bandwidth contracts when [configuring an SSID](#) or [wired profile](#).

In the CLI:

To assign a bandwidth contract in the CLI:

```
(Instant AP) (config)# wlan access-rule <name>
(Instant AP) (Access Rule <name>)# bandwidth-limit {downstream <kbps>| upstream <kbps>|peruser
{downstream <kbps>| upstream <kbps>}}
(Instant AP) (Access Rule <name>)# end
(Instant AP) # commit apply
```

To associate the access rule to a wired profile:

```
(Instant AP) (config)# wired-port-profile <name>
(Instant AP) (wired ap profile <name>)# access-rule-name <access-rule-name>
(Instant AP) (wired ap profile <name>)# end
(Instant AP) # commit apply
```

Configuring Machine and User Authentication Roles

You can assign different rights to clients based on whether their hardware device supports machine authentication. Machine Authentication is only supported on Windows devices, so this can be used to distinguish between Windows devices and other devices such as iPads.

You can create any of the following types of rules:

- **Machine Auth only** role—This indicates a Windows machine with no user logged in. The device supports machine authentication and has a valid RADIUS account, but a user has not yet logged in and authenticated.
- **User Auth only** role—This indicates a known user or a non-Windows device. The device does not support machine authentication or does not have a RADIUS account, but the user is logged in and authenticated.

When a device does both machine and user authentication, the user obtains the default role or the derived role based on the RADIUS attribute.

You can configure machine authentication with role-based access control using the AOS-W Instant UI or CLI.

In the AOS-W Instant UI

To configure machine authentication with role-based access control:

1. In the **Access** tab of the WLAN wizard (**New WLAN** or **Edit <WLAN-profile>**) or wired profile configuration window (**New Wired Network** or **Edit Wired Network**), under **Roles**, create **Machine auth only** and **User auth only** roles.
2. Configure access rules for these roles by selecting the role, and applying the rule. For more information on configuring access rules, see [Configuring ACL Rules for Network Services on page 189](#).
3. Select **Enforce Machine Authentication** and select the **Machine auth only** and **User auth only** roles.
4. Click **Finish** to apply these changes.

In the CLI

To configure machine and user authentication roles for a WLAN SSID:

```
(Instant AP) (config)# wlan ssid-profile <name>
(Instant AP) (SSID Profile <name>)# set-role-machine-auth <machine_only> <user_only>
(Instant AP) (SSID Profile <name>)# end
(Instant AP)# commit apply
```

To configure machine and user authentication roles for wired profile:

```
(Instant AP) (config)# wired-port-profile <name>
(Instant AP) (wired ap profile <name>)# set-role-machine-auth <machine_only> <user_only>
(Instant AP) (wired ap profile <name>)# end
(Instant AP)# commit apply
```

Configuring Derivation Rules

AOS-W Instant allows you to configure role and VLAN derivation-rules. You can configure these rules to assign a user role or VLAN to the clients connecting to an SSID or a wired profile.

Understanding Role Assignment Rule

When an SSID or wired profile is created, a default role for the clients connecting this SSID or wired profile is assigned. You can assign a user role to the clients connecting to an SSID by any of the following methods. The role assigned by some methods may take precedence over the roles assigned by the other methods.

RADIUS VSA Attributes

The user role can be derived from Alcatel-Lucent Vendor-Specific Attributes (VSA) for RADIUS server authentication. The role derived from an Alcatel-Lucent VSA takes precedence over roles defined by other methods.

MAC-Address Attribute

The first three octets in a MAC address are known as Organizationally Unique Identifier (OUI), and are purchased from the Institute of Electrical and Electronics Engineers, Incorporated (IEEE) Registration Authority. This identifier uniquely identifies a vendor, manufacturer, or other organization (referred to by the IEEE as the "assignee") globally and effectively reserves a block of each possible type of derivative identifier (such as MAC addresses) for the exclusive use of the assignee.

OAW-IAPs use the OUI part of a MAC address to identify the device manufacturer and can be configured to assign a desired role for users who have completed 802.1X authentication and MAC authentication. The user role can be derived from the user attributes after a client associates with an AP. You can configure rules that assign a user role to clients that match a MAC address based criteria. For example, you can assign a voice role to any client with a MAC address starting a0:a1:a2.

Roles Based on Client Authentication

The user role can be the default user role configured for an authentication method, such as 802.1X authentication. For each authentication method, you can configure a default role for clients who are successfully authenticated using that method.

DHCP Option and DHCP Fingerprinting

The DHCP fingerprinting allows you to identify the operating system of a device by looking at the options in the DHCP frame. Based on the operating system type, a role can be assigned to the device.

For example, to create a role assignment rule with the DHCP option, select **equals** from the **Operator** drop-down list and enter 370103060F77FC in the **String** text box. Since 370103060F77FC is the fingerprint for Apple iOS devices such as iPad and iPhone, OAW-IAP assigns Apple iOS devices to the role that you choose.

Table 39: Validated DHCP Fingerprint

Device	DHCP Option	DHCP Fingerprint
Apple iOS	Option 55	370103060F77FC
Android	Option 60	3C64686370636420342E302E3135
Blackberry	Option 60	3C426C61636B4265727279
Windows 7/Vista Desktop	Option 55	37010f03062c2e2f1f2179f92b
Windows XP(SP3, Home, Professional)	Option 55	37010f03062c2e2f1f21f92b
Windows Mobile	Option 60	3c4d6963726f736f66742057696e646f777320434500
Windows 7 Phone	Option 55	370103060f2c2e2f
Apple Mac OS X	Option 55	370103060f775ffc2c2e2f

Creating a Role Derivation Rule

You can configure rules for determining the role that is assigned for each authenticated client.



When creating more than one role assignment rule, the first matching rule in the rule list is applied.

You can create a role assignment rules by using the AOS-W Instant UI or CLI.

In the AOS-W Instant UI

1. Navigate to the WLAN wizard or Wired settings window:
 - To configure access rules for a WLAN SSID, in the **Network** tab, click **New** to create a new network profile or **edit** to modify an existing profile.

- To configure access rules for a wired profile, **More > Wired**. In the **Wired** window, click **New** under **Wired Networks** to create a new network or click **Edit** to select an existing profile.
2. Click the **Access** tab.
 3. Under **Role Assignment Rules**, click **New**. The **New Role Assignment** window allows you to define a match method by which the string in *Operand* is matched with the attribute value returned by the authentication server.
 4. Select the attribute from the **Attribute** drop-down list that the rule it matches against. The list of supported attributes includes RADIUS attributes, dhcp-option, dot1x-authentication-type, mac-address, and mac-address-and-dhcp-options. For information on a list of RADIUS attributes, see [RADIUS Server Authentication with VSA on page 159](#).
 5. Select the operator from the **Operator** drop-down list. The following types of operators are supported:
 - **contains**— The rule is applied only if the attribute value contains the string specified in *Operand*.
 - **Is the role**— The rule is applied if the attribute value is the role.
 - **equals**— The rule is applied only if the attribute value is equal to the string specified in *Operand*.
 - **not-equals**— The rule is applied only if the attribute value is not equal to the string specified in *Operand*.
 - **starts-with**— The rule is applied only if the attribute value starts with the string specified in *Operand*.
 - **ends-with**— The rule is applied only if the attribute value ends with string specified in *Operand*.
 - **matches-regular-expression**— The rule is applied only if the attribute value matches the regular expression pattern specified in *Operand*. This operator is available only if the **mac-address-and-dhcp-options** attribute is selected in the **Attribute** drop-down. The **mac-address-and-dhcp-options** attribute and **matches-regular-expression** are applicable only for the WLAN clients.
 6. Enter the string to match in the **String** text box.
 7. Select the appropriate role from the **Role** drop-down list.
 8. Click **OK**.



When **Enforce Machine Authentication** is enabled, both the device and the user must be authenticated for the role assignment rule to apply.

In the CLI

To configure role assignment rules for a WLAN SSID:

```
(Instant AP) (config)# wlan ssid-profile <name>
(Instant AP) (SSID Profile <name>)# set-role <attribute>{{equals|not-equals|starts-with|ends-with|contains|matches-regular-expression} <operator><role>|value-of}
(Instant AP) (SSID Profile <name>)# end
(Instant AP)# commit apply
```

To configure role assignment rules for a wired profile:

```
(Instant AP) (config)# wired-port-profile <name>
(Instant AP) (wired ap profile <name>)# set-role <attribute>{{equals| not-equal| starts-with| ends-with|contains}<operator> <role>| value-of}
(Instant AP) (wired ap profile <name>)# end
(Instant AP)# commit apply
```

Example

```
(Instant AP) (config)# wlan ssid-profile Profile1
(Instant AP) (SSID Profile "Profile1")# set-role mac-address-and-dhcp-options matches-regular-expression \bring\b Profile1
(Instant AP) (SSID Profile"Profile1")# end
(Instant AP)# commit apply
```

Understanding VLAN Assignment

You can assign VLANs to a client based on the following configuration conditions:

- The default VLAN configured for the WLAN can be assigned to a client.
- If VLANs are configured for a WLAN SSID or an Ethernet port profile, the VLAN for the client can be derived before the authentication, from the rules configured for these profiles.
- If a rule derives a specific VLAN, it is prioritized over the user roles that may have a VLAN configured.
- The user VLANs can be derived from the default roles configured for 802.1X authentication or MAC authentication.
- After client authentication, the VLAN can be derived from Vendor Specific Attributes (VSA) for RADIUS server authentication.
- The DHCP-based VLANs can be derived for captive portal authentication.



AOS-W Instant supports role derivation based on the DHCP option for captive portal authentication. When the captive portal authentication is successful, the role derivation based on the DHCP option assigns a new user role to the guest users, instead of the pre-authenticated role.

Vendor Specific Attributes

When an external RADIUS server is used, the user VLAN can be derived from the **Alcatel-Lucent-User-Vlan** VSA. The VSA is then carried in an *Access-Accept* packet from the RADIUS server. The OAW-IAP can analyze the return message and derive the value of the VLAN which it assigns to the user.

Figure 45 RADIUS Access-Accept packets with VSA

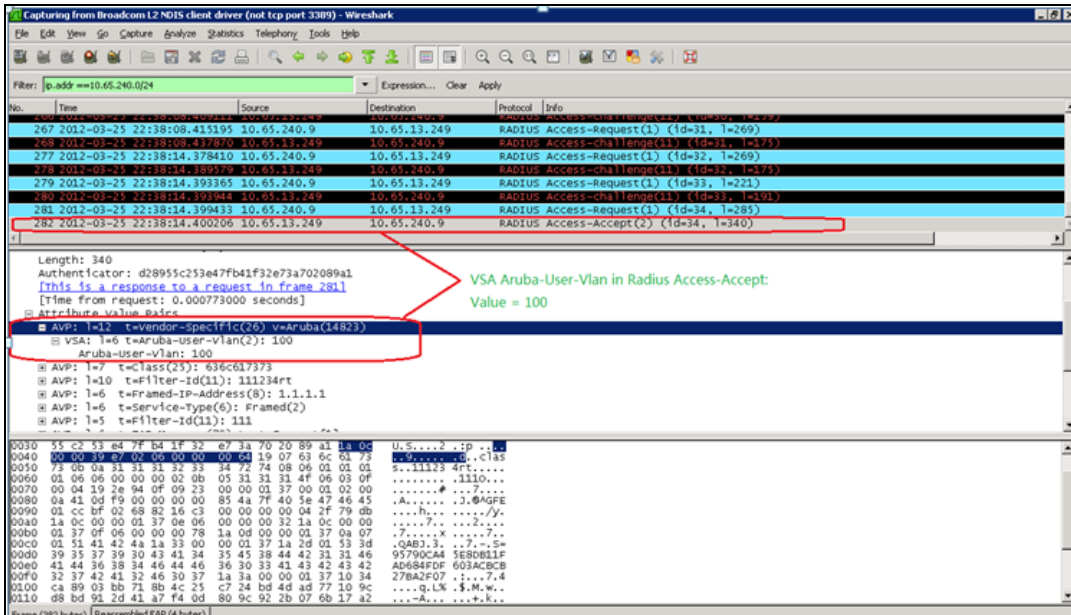
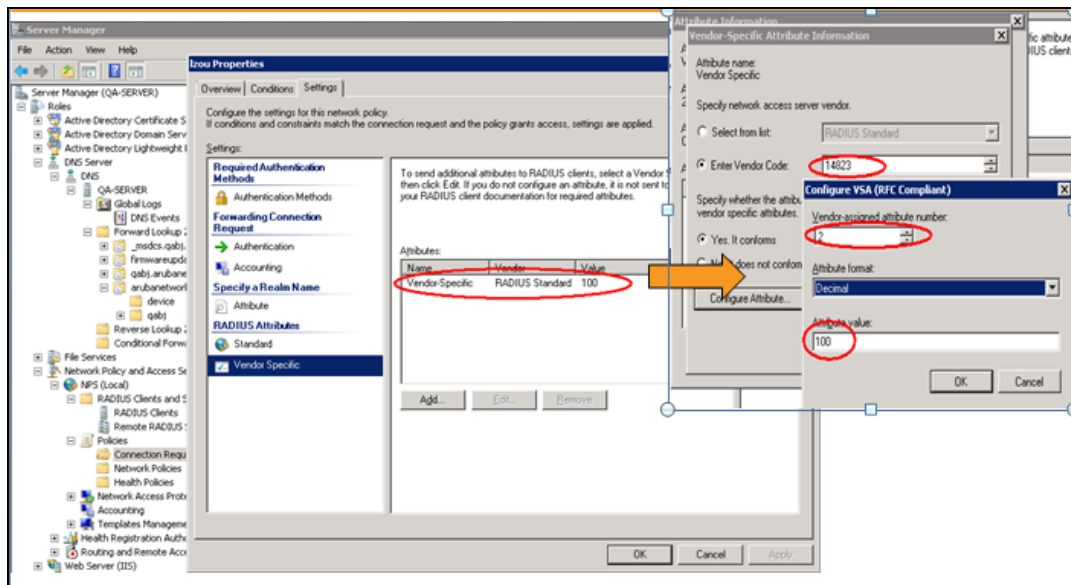

Figure 46 Configure VSA on a RADIUS Server



VLAN Assignment Based on Derivation Rules

When an external RADIUS server is used for authentication, the RADIUS server may return a reply message for authentication. If the RADIUS server supports return attributes, and sets an attribute value to the reply message, the OAW-IAP can analyze the return message and match attributes with a user pre-defined VLAN derivation rule. If the rule is matched, the VLAN value defined by the rule is assigned to the user. For a complete list of RADIUS server attributes, see [RADIUS Server Authentication with VSA on page 159](#).

Figure 47 Configuring RADIUS Attributes on the RADIUS Server

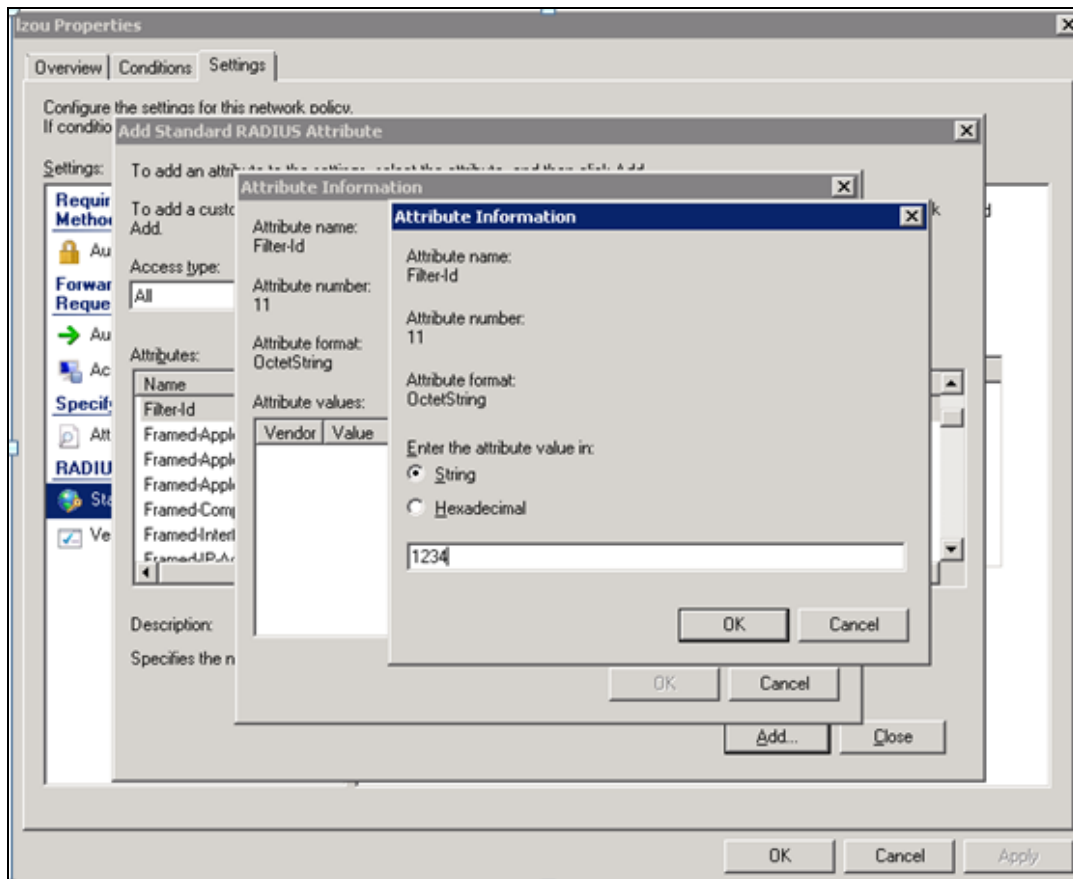

User Role

If the VSA and VLAN derivation rules are not matching, then the user VLAN can be derived by a user role.

VLANs Created for an SSID

If the VSA and VLAN derivation rules are not matching, and the User Role does not contain a VLAN, the user VLAN can be derived by VLANs configured for an SSID or Ethernet port profile.

Configuring VLAN Derivation Rules

The VLAN derivation rules allow administrators to assign a VLAN to the OAW-IAP clients based on the attributes returned by the RADIUS server.

You can configure VLAN derivation rules for an SSID profile by using the AOS-W Instant UI or CLI.

In the AOS-W Instant UI

1. Perform the following steps:
 - To configure VLAN derivation rule for a WLAN SSID profile, navigate to **Network > New > New WLAN > VLAN** or **Network > edit > Edit <WLAN-profile> > VLAN**. Select the **Dynamic** option under the **Client VLAN assignment**.
 - To configure VLAN derivation rule for a wired network profile, navigate to **Wired > New > New Wired Network > VLAN** or **Wired > Edit > Edit Wired Network > VLAN**. The **VLAN** tab contents are displayed.
2. Click **New** to create a VLAN assignment rule. The **New VLAN Assignment Rule** window is displayed. In this window, you can define a match method by which the string in *Operand* is matched with the attribute values returned by the authentication server.

Figure 48 VLAN Assignment Rule Window

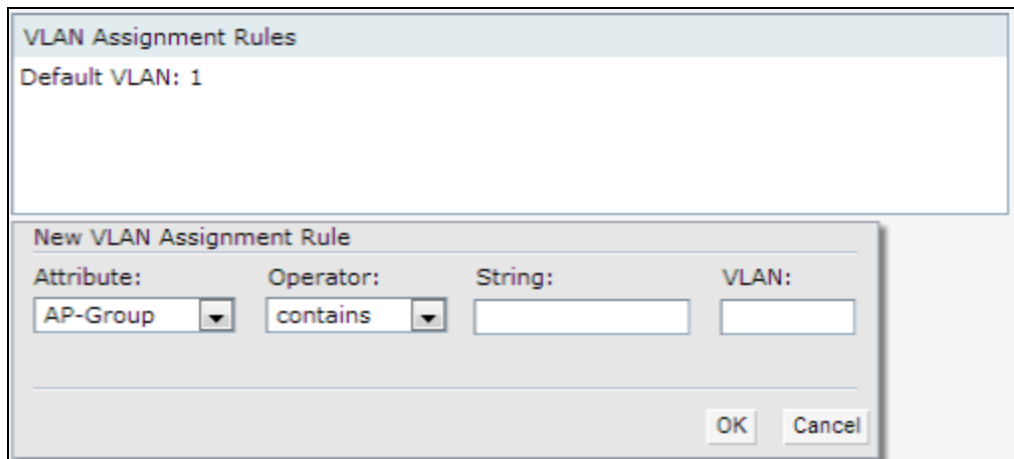

3. Select the attribute from the **Attribute** drop-down list. The list of supported attributes includes RADIUS attributes, dhcp-option, dot1x-authentication-type, mac-address, and mac-address-and-dhcp-options. For information on a list of RADIUS attributes, see [RADIUS Server Authentication with VSA on page 159](#).
4. Select the operator from the **Operator** drop-down list. The following types of operators are supported:
 - **contains**— The rule is applied only if the attribute value contains the string specified in *Operand*.
 - **Is the VLAN**— The rule is applied if the VLAN is the same as the one returned by the RADIUS attribute.
 - **equals**— The rule is applied only if the attribute value is equal to the string specified in *Operand*.
 - **not-equals**—The rule is applied only if the attribute value is not equal to the string specified in *Operand*.
 - **starts-with**—The rule is applied only if the attribute value starts with the string specified in *Operand*.
 - **ends-with**—The rule is applied only if the attribute value ends with string specified in *Operand*.

5. Enter the string to match in the **String** field.
6. Select the appropriate VLAN ID from the **VLAN** drop-down list.
7. Click **OK**.
8. Ensure that the required security and access parameters are configured.
9. Click **Finish** to apply the changes.

In the CLI

To create a VLAN assignment rule for WLAN SSID:

```
(Instant AP) (config)# wlan ssid-profile <name>
(Instant AP) (SSID Profile <name>)# set-vlan <attribute>{equals|not-equals|starts-with|ends-
with|contains}<operator><VLAN-ID>|value-of}
(Instant AP) (SSID Profile <name>)# end
(Instant AP)# commit apply
```

To configure a VLAN assignment rule for a wired profile:

```
(Instant AP) (config)# wired-port-profile <nname>
(Instant AP) (wired ap profile <name>)# set-vlan <attribute>{equals|not-equals|starts-
with|ends-with|contains}<operator><VLAN-ID>|value-of}
(Instant AP) (wired ap profile <name>)# end
(Instant AP)# commit apply
```

Example

```
(Instant AP) (config)# wlan ssid-profile Profile1
(Instant AP) (SSID Profile "Profile1")# set-vlan mac-address-and-dhcp-options matches-regular-
expression ..link 100
(Instant AP) (SSID Profile "Profile1")# end
(Instant AP)# commit apply
```

Using Advanced Expressions in Role and VLAN Derivation Rules

For complex policies of role and VLAN derivation using device DHCP fingerprints, you can use a regular expression to match against the combined string of the MAC address and the DHCP options. The combined string is formed by concatenating the hexadecimal presentation of the MAC address and all of the DHCP options sent by a particular device. The regular expression is a powerful pattern description language that can be used to perform advanced pattern matching of the above string.

If the combined device fingerprint string matches the specified regular expression, the role or VLAN can be set to the WLAN client.

The following table lists some of the most commonly used regular expressions, which can be used in user role and user VLAN derivation rules:

Operator	Description
.	Matches any character. For example, l..k matches lack, lark, link, lock, look, Lync and so on.
\	Matches the character that follows the backslash. For example, \192.\.0\.. matches IP addresses ranges that starting with 192.0, such as 192.0.1.1. The expression looks only for the single characters that match.
[]	Matches any one character listed between the brackets. For example, [bc]lock matches block and clock.

Operator	Description
\b	Matches the words that begin and end with the given expression. For example, \bdown matches downlink, linkdown, shutdown.
\B	Matches the middle of a word. For example, \Bvice matches services, devices, serviceID, deviceID, and so on.
^	Matches the characters at starting position in a string. For example, ^bcd matches bcde or bcdf, but not abcd.
[^]	Matches any characters that are not listed between the brackets. For example, [^u]link matches downlink, link, but not uplink.
?	Matches any one occurrence of the pattern. For example, ?est matches best, nest, rest, test and so on.
\$	Matches the end of an input string. For example, eth\$ matches Eth, but not Ethernet.
*	Matches the declared element multiple times if it exists. For example, eth* matches all occurrences of eth, such as Eth, Ethernet, Eth0 and so on.
+	Matches the declared element one or more times. For example, aa+ matches occurrences of aa and aaa.
()	Matches nested characters. For example, (192)* matches any number of the character string 192.
	Matches the character patterns on either side of the vertical bar. You can use this expression to construct a series of options.
\<	Matches the beginning of the word. For example, \<wire matches wired, wireless and so on.
\>	Matches the end of the word. For example, \>list matches blacklist, whitelist, and so on.
{n}	Where n is an integer. Matches the declared element exactly the n times. For example, {2}link matches uplink, but not downlink.
{n,}	Where n is an integer. Matches the declared element at n times. For example, {2,}ink matches downlink, but not uplink.

For information on how to use regular expressions in role and VLAN derivation rules, see the following topics:

- [Configuring VLAN Derivation Rules on page 211](#)
- [Creating a Role Derivation Rule on page 207](#)

Configuring a User Role for VLAN Derivation

This section describes the following procedures:

- [Creating a User VLAN Role on page 214](#)
- [Assigning User VLAN Roles to a Network Profile on page 214](#)

Creating a User VLAN Role

You can create a user role for VLAN derivation using the AOS-W Instant UI or CLI.

In the AOS-W Instant UI

To configure a user role for VLAN derivation:

1. Click the **Security** link at the top right corner of the AOS-W Instant main window.
2. Click the **Roles** tab. The Roles tab contents are displayed.
3. Under **Roles**, click **New**.
4. Enter a name for the new role and click **OK**.
5. Under **Access rules**, click **New**.
6. Select the **Rule type** as **VLAN assignment**.
7. Enter the ID of the VLAN in the **VLAN ID** text box.
8. Click **OK**.

In the CLI

To create a VLAN role:

```
(Instant AP) (config)# wlan access-rule <rule-name>
(Instant AP) (Access Rule <rule-name>)# vlan 200
(Instant AP) (Access Rule <rule-name>)# end
(Instant AP)# commit apply
```

Assigning User VLAN Roles to a Network Profile

You can configure user VLAN roles for a network profile using AOS-W Instant UI or CLI.

In the AOS-W Instant UI

To assign a user VLAN role:

1. Click **Network > New > New WLAN > Access** or **Network > edit > Edit <WLAN-profile> > Access**.
2. On the **Access** tab, ensure that the slider is at the **Role-based** option.
3. Click **New** under the **New Role Assignment** and configure the following parameters:
 - a. Select the attribute from the **Attribute** drop-down list.
 - b. Select the operator to match from the **Operator** drop-down list.
 - c. Enter the string to match in the **String** text box.
 - d. Select the role to be assigned from the **Role** text box.
4. Click **OK**.

In the CLI

To assign VLAN role to a WLAN profile:

```
(Instant AP) (config)# wlan ssid-profile <name>
(Instant AP) (SSID Profile <name>)# set-role <attribute>{{equals <operator> <role>| not-equals
<operator> <role>| starts-with <operator> <role>| ends-with <operator> <role>| contains
<operator> <role>}|value-of}
(Instant AP) (SSID Profile <name>)# end
(Instant AP)# commit apply
```

This chapter provides the following information:

- [Configuring DHCP Scopes on page 215](#)
- [Configuring the Default DHCP Scope for Client IP Assignment on page 222](#)

Configuring DHCP Scopes

The virtual controller supports different modes of DHCP address assignment. With each DHCP address assignment mode, various client traffic forwarding modes are associated. For more information on client traffic forwarding modes for IAP-VPN, see [IAP-VPN Forwarding Modes on page 247](#).

When using a local DHCP scope in an OAW-IAP cluster, ensure that the VLANs configured for this DHCP scope is allowed in the uplink switch.



In a single OAW-IAP network, when using a client DHCP scope for wired clients, ensure that client VLAN is not added in the allowed VLAN list for the port to which the OAW-IAP E0 port is connected.

This section describes the following procedures:

- [Configuring Local DHCP Scopes on page 215](#)
- [Configuring Distributed DHCP Scopes on page 217](#)
- [Configuring Centralized DHCP Scopes on page 220](#)

Configuring Local DHCP Scopes

You can configure Local, Local, L2, and Local, L3 DHCP scopes through the AOS-W Instant UI or CLI.

- **Local**—In this mode, the Virtual Controller acts as both the DHCP Server and the default gateway. The configured subnet and the corresponding DHCP scope are independent of subnets configured in other OAW-IAP clusters. The Virtual Controller assigns an IP address from a local subnet and forwards traffic to both **corporate** and **non-corporate** destinations. The network address is translated appropriately and the packet is forwarded through the IPsec tunnel or through the uplink. This DHCP assignment mode is used in the NAT forwarding mode.
- **Local, L2**—In this mode, the Virtual Controller acts as a DHCP server and the gateway located outside the OAW-IAP.
- **Local, L3**— This DHCP assignment mode is used with the L3 forwarding mode. In this mode, the Virtual Controller acts as a DHCP server and the gateway, and assigns an IP address from the local subnet. The OAW-IAP routes the packets sent by clients on its uplink. The Local, L3 subnets can access corporate network through the IPsec tunnel. The network address for all client traffic, which is generated in the Local, L3 subnets and destined to the corporate network, is translated at the source with the tunnel inner IP. However, if corporate access to Local, L3 is not required, you can configure ACL rules to deny access.

In the AOS-W Instant UI

To configure a Local or Local, L3 DHCP scope:

1. Click **More > DHCP Server**. The **DHCP Server** window is displayed.
2. To configure a **Local, Local, L2** or **Local, L3** DHCP scopes, click **New** under **Local DHCP Scopes**. The **New DHCP Scope** window is displayed.

3. Based on type of DHCP scope selected, configure the following parameters:

Table 40: Local DHCP Mode Configuration Parameters

Name	Description
Name	Enter a name for the DHCP scope.
Type	Select any of the following options: <ul style="list-style-type: none"> • Local—On selecting Local, the DHCP server for local branch network is used for keeping the scope of the subnet local to the OAW-IAP. In the NAT mode, the traffic is forwarded through the IPsec tunnel or the uplink. • Local, L2—On selecting Local, L2, the Virtual Controller acts as a DHCP server and a default gateway in the local network is used. • Local, L3—On selecting Local, L3, the Virtual Controller acts as a DHCP server and gateway. In this mode, the network address for traffic destined to the corporate network is translated at the source with the inner IP of the IPsec tunnel and is forwarded through the IPsec tunnel. The traffic destined to the non-corporate network is routed.
VLAN	Specify a VLAN ID. To use this subnet, ensure that the VLAN ID specified here is assigned to an SSID profile. For more information on SSID profile configuration, see Configuring VLAN Settings for a WLAN SSID Profile on page 95 and Configuring VLAN for a Wired Profile on page 116 .
Network	Specify the network to use.
Netmask	If Local, Local, L2 or Local, L3 is selected, specify the subnet mask. The subnet mask and the network determine the size of subnet.
Excluded address	Specify a range of IP addresses to exclude. You can add up to two exclusion ranges. Based on the size of the subnet and the value configured for Excluded address , the IP addresses either before or after the defined range are excluded.
Default Router	If Local, L2 is selected for type of DHCP scope, specify the IP address of the default router.
DNS Server	If required, specify the IP address of a DNS server for the Local, Local, L2 and Local, L3 scopes.
Domain Name	If required, specify the domain name for the Local, Local, L2 , and Local, L3 scopes.
Lease Time	Specify a lease time for the client in minutes within a range of 2–1440 minutes. The default value is 720 minutes.
Option	Specify the type and a value for the DHCP option. You can configure the organization-specific DHCP options supported by the DHCP server. For example, 176, 242, and 161. To add multiple DHCP options, click the + icon.

4. Click **OK**.

In the CLI

To configure Local DHCP scope:

```
(Instant AP) (config)# ip dhcp <profile-name>
```



```
(Instant AP) (DHCP Profile <profile-name>)# server-type <local>
(Instant AP) (DHCP Profile <profile-name>)# server-vlan <vlan-ID>
(Instant AP) (DHCP Profile <profile-name>)# subnet <IP-address>
(Instant AP) (DHCP Profile <profile-name>)# subnet-mask <subnet-mask>
(Instant AP) (DHCP Profile <profile-name>)# dns-server <name>
(Instant AP) (DHCP Profile <profile-name>)# domain-name <domain-name>
(Instant AP) (DHCP Profile <profile-name>)# lease-time <seconds>
(Instant AP) (DHCP Profile <profile-name>)# option <type> <value>
(Instant AP) (DHCP Profile <profile-name>)# end
(Instant AP)# commit apply
```

To configure Local, L2 DHCP scope:

```
(Instant AP) (config)# ip dhcp <profile-name>
(Instant AP) (DHCP Profile <profile-name>)# server-type <local,l2>
(Instant AP) (DHCP Profile <profile-name>)# server-vlan <vlan-ID>
(Instant AP) (DHCP Profile <profile-name>)# subnet <IP-address>
(Instant AP) (DHCP Profile <profile-name>)# subnet-mask <subnet-mask>
(Instant AP) (DHCP Profile <profile-name>)# exclude-address <IP-address>
(Instant AP) (DHCP Profile <profile-name>)# default-router
(Instant AP) (DHCP Profile <profile-name>)# dns-server <name>
(Instant AP) (DHCP Profile <profile-name>)# domain-name <domain-name>
(Instant AP) (DHCP Profile <profile-name>)# lease-time <seconds>
(Instant AP) (DHCP Profile <profile-name>)# option <type> <value>
(Instant AP) (DHCP Profile <profile-name>)# end
(Instant AP)# commit apply
```

To configure Local, L3 DHCP scope:

```
(Instant AP) (config)# ip dhcp <profile-name>
(Instant AP) (DHCP Profile <profile-name>)# server-type <local,l3>
(Instant AP) (DHCP Profile <profile-name>)# server-vlan <vlan-ID>
(Instant AP) (DHCP Profile <profile-name>)# subnet <IP-address>
(Instant AP) (DHCP Profile <profile-name>)# subnet-mask <subnet-mask>
(Instant AP) (DHCP Profile <profile-name>)# exclude-address <IP-address>
(Instant AP) (DHCP Profile <profile-name>)# dns-server <name>
(Instant AP) (DHCP Profile <profile-name>)# domain-name <domain-name>
(Instant AP) (DHCP Profile <profile-name>)# lease-time <seconds>
(Instant AP) (DHCP Profile <profile-name>)# option <type> <value>
(Instant AP) (DHCP Profile <profile-name>)# end
(Instant AP)# commit apply
```

Configuring Distributed DHCP Scopes

AOS-W Instant allows you to configure the DHCP address assignment for the branches connected to the corporate network through VPN. You can configure the range of DHCP IP addresses used in the branches and the number of client addresses allowed per branch. You can also specify the IP addresses that must be excluded from those assigned to clients, so that they are assigned statically.

AOS-W Instant supports the following distributed DHCP scopes:

- **Distributed, L2**—In this mode, the Virtual Controller acts as the DHCP server, but the default gateway is in the data center. Based on the number of clients specified for each branch, the range of IP addresses is divided. Based on the IP address range and client count configuration, the DHCP server in the Virtual Controller controls a scope that is a subset of the complete IP Address range for the subnet distributed across all the branches. This DHCP Assignment mode is used with the L2 forwarding mode.
- **Distributed, L3**—In this mode, the Virtual Controller acts as the DHCP server and the default gateway. Based on the number of clients specified for each branch, the range of IP addresses is divided. Based on the IP address range and client count configuration, the DHCP server in the Virtual Controller is configured with a unique subnet and a corresponding scope.

You can configure distributed DHCP scopes such as Distributed, L2 or Distributed, L3 by using the AOS-W Instant UI or CLI.

In the AOS-W Instant UI

To configure distributed DHCP scopes such as Distributed,L2 or Distributed,L3:

1. Click **More > DHCP Server**. The **DHCP Server** window is displayed.
2. To configure a distributed DHCP mode, click **New** under **Distributed DHCP Scopes**. The **New DHCP Scope** window is displayed. The following figure shows the contents of the **New DHCP Scope** window.

Figure 49 New DHCP Scope: Distributed DHCP Mode

3. Based on the type of distributed DHCP scope, configure the following parameters:

Table 41: Distributed DHCP Mode Configuration Parameters

Name	Description
Name	Enter a name for the DHCP scope.
Type	Select any of the following options: <ul style="list-style-type: none"> ● Distributed, L2— On selecting Distributed, L2, the Virtual Controller acts as the DHCP Server but the default gateway is in the data center. Traffic is bridged into VPN tunnel. ● Distributed, L3— On selecting Distributed, L3, the Virtual Controller acts as both DHCP Server and default gateway. Traffic is routed into the VPN tunnel.
VLAN	Specify a VLAN ID. To use this subnet, ensure that the VLAN ID specified here is assigned to an SSID profile. For more information on SSID profile configuration, see Configuring VLAN Settings for a WLAN SSID Profile on page 95 and Configuring VLAN for a Wired Profile on page 116
Netmask	If Distributed, L2 is selected for type of DHCP scope, specify the subnet mask. The subnet mask and the network determine the size of subnet.

Table 41: Distributed DHCP Mode Configuration Parameters

Name	Description
Default router	If Distributed, L2 is selected for type of DHCP scope, specify the IP address of the default router.
DNS Server	If required, specify the IP address of a DNS server.
Domain Name	If required, specify the domain name.
Lease Time	Specify a lease time for the client in minutes within a range of 2–1440 minutes. The default value is 720 minutes.
Dynamic DNS	Select the Dynamic DNS checkbox to enable dynamic dns on the Distributed, L3 client. Key — Enter the TSIG shared secret key.
IP Address Range	Specify a range of IP addresses to use. To add another range, click the + icon. You can specify up to four different ranges of IP addresses. <ul style="list-style-type: none"> For Distributed, L2 mode, ensure that all IP ranges are in the same subnet as the default router. On specifying the IP address ranges, a subnet validation is performed to ensure that the specified ranges of IP address are in the same subnet as the default router and subnet mask. The configured IP range is divided into blocks based on the configured client count. For Distributed, L3 mode, you can configure any discontinuous IP ranges. The configured IP range is divided into multiple IP subnets that are sufficient to accommodate the configured client count. <p>NOTE: You can allocate multiple branch IDs (BID) per subnet. The OAW-IAP generates a subnet name from the DHCP IP configuration, which the switch can use as a subnet identifier. If static subnets are configured in each branch, all of them are assigned the with BID 0, which is mapped directly to the configured static subnet.</p>
Option	Specify the type and a value for the DHCP option. You can configure the organization-specific DHCP options supported by the DHCP server. For example, 176, 242, 161, and so on. To add multiple DHCP options, click the + icon. You can add up to eight DHCP options.

- Click **Next**.
- Specify the number of clients to use per branch. The client count configured for a branch determines the use of IP addresses from the IP address range defined for a DHCP scope. For example, if 20 IP addresses are available in an IP address range configured for a DHCP scope and a client count of 9 is configured, only a few IP addresses (in this example, 9) from this range will be used and allocated to a branch. The OAW-IAP does not allow the administrators to assign the remaining IP addresses to another branch, although a lower value is configured for the client count.
- Click **Next**. The **Static IP** tab is displayed. Specify the number of first and last IP addresses to reserve in the subnet.
- Click **Finish**.

In the CLI

To configure Distributed, L2 DHCP scope:

```
(Instant AP) (config)# ip dhcp <profile-name>
```

```
(Instant AP) (DHCP Profile <profile-name>)# ip dhcp server-type <Distributed,L2>
(Instant AP) (DHCP Profile <profile-name>)# server-vlan <vlan-ID>
(Instant AP) (DHCP Profile <profile-name>)# subnet-mask <subnet-mask>
(Instant AP) (DHCP Profile <profile-name>)# default-router <IP-address>
(Instant AP) (DHCP Profile <profile-name>)# client-count <number>
(Instant AP) (DHCP Profile <profile-name>)# dns-server <name>
(Instant AP) (DHCP Profile <profile-name>)# domain-name <domain-name>
(Instant AP) (DHCP Profile <profile-name>)# lease-time <seconds>
(Instant AP) (DHCP Profile <profile-name>)# ip-range <start-IP> <end-IP>
(Instant AP) (DHCP Profile <profile-name>)# reserve {first|last} <count>
(Instant AP) (DHCP Profile <profile-name>)# option <type> <value>
(Instant AP) (DHCP Profile <profile-name>)# end
(Instant AP)# commit apply
```

To configure Distributed,L3 DHCP scope:

```
(Instant AP) (config)# ip dhcp <profile-name>
(Instant AP) (DHCP Profile <profile-name>)# ip dhcp server-type <Distributed,L3>
(Instant AP) (DHCP Profile <profile-name>)# server-vlan <vlan-ID>
(Instant AP) (DHCP Profile <profile-name>)# client-count <number>
(Instant AP) (DHCP Profile <profile-name>)# dns-server <name>
(Instant AP) (DHCP Profile <profile-name>)# domain-name <domain-name>
(Instant AP) (DHCP Profile <profile-name>)# lease-time <seconds>
(Instant AP) (DHCP Profile <profile-name>)# dynamic-dns [key <TSIG KEY>]
(Instant AP) (DHCP Profile <profile-name>)# ip-range <start-IP> <end-IP>
(Instant AP) (DHCP Profile <profile-name>)# reserve {first | last} <count>
(Instant AP) (DHCP Profile <profile-name>)# option <type> <value>
(Instant AP) (DHCP Profile <profile-name>)# end
(Instant AP)# commit apply
```

Configuring Centralized DHCP Scopes

When a centralized DHCP scope is configured:

- The Virtual Controller does not assign an IP address to the client and the DHCP traffic is directly forwarded to the DHCP Server.
- For Centralized, L2 clients, the Virtual Controller bridges the DHCP traffic to the switch over the VPN/GRE tunnel. The IP address is obtained from the DHCP server behind the switch serving the VLAN/GRE of the client. This DHCP assignment mode also allows you to add the DHCP option 82 to the DHCP traffic forwarded to the switch.
- For Centralized, L3 clients, the Virtual Controller acts as a DHCP relay agent that forwards the DHCP traffic to the DHCP server located either in the corporate or local network. The centralized L3 VLAN IP is used as the source IP. The IP address is obtained from the DHCP server.

You can configure a centralized DHCP scope through the AOS-W Instant UI or CLI.

In the AOS-W Instant UI

To configure a centralized DHCP scope:

1. Click **More > DHCP Server**. The **DHCP Server** window is displayed.
2. To configure a centralized DHCP scopes, click **New** under **Centralized DHCP Scopes**. The **New DHCP Scope** window is displayed.
3. To configure centralized,L2 profile, select the profile type as **Centralized,L2** or **Centralized,L3** and configure the following parameters.

Table 42: Centralized DHCP Mode Configuration Parameters

Name	Description
Name	Enter a name for the DHCP scope.
Type	Set the type as follows: <ul style="list-style-type: none"> ● Centralized,L2 for the centralized,L2 profile ● Centralized,L3 for the centralized,L3 profile
VLAN	Specify a VLAN ID. To use this subnet, ensure that the VLAN ID specified here is assigned to an SSID profile. For more information on SSID profile configuration, see Configuring VLAN Settings for a WLAN SSID Profile on page 95 and Configuring VLAN for a Wired Profile on page 116 .
Split tunnel	Set this to Enabled or Disabled for split tunnel functionality for the centralized,L2 subnet. Enabling split tunnel allows a VPN user to access a public network and a local LAN or WAN network at the same time through the same physical network connection. For example, a user can use a remote access VPN software client connecting to a corporate network using a home wireless network. The user with split tunneling enabled is able to connect to file servers, database servers, mail servers and other servers on the corporate network through the VPN connection. When the user connects to Internet resources (websites, FTP sites and so on), the connection request goes directly out the gateway provided by the home network. The split-DNS functionality intercepts DNS requests from clients for non-corporate domains (as configured in Enterprise Domains list) and forwards to AP's own DNS server. When split-tunnel is disabled, all the traffic including the corporate and Internet traffic is tunneled irrespective of the routing profile specifications. If the GRE tunnel is down and when the corporate network is not reachable, the client traffic is dropped.
DHCP relay	If you are configuring a Centralized, L2 DHCP profile, you can select Enabled to allow the OAW-IAPs to intercept the broadcast packets and relay DHCP requests to centralized DHCP server. NOTE: The DHCP relay option is not available for centralized,L3 profile configuration.
Helper address	Specify the IP address of the DHCP server. NOTE: For Centralized, L2 DHCP profiles, the Helper address option is displayed only when DHCP relay is enabled.
VLAN IP	Specify the Centralized L3 DHCP subnet gateway IP.
VLAN Mask	Specify the subnet mask of the Centralized L3 DHCP subnet gateway IP.
Option82	Select Alcatel to enable DHCP Option 82 to allow clients to send DHCP packets with the Option 82 string. The Option 82 string is available only in the Alcatel (ALU) format. The ALU format for the Option 82 string consists of the following: <ul style="list-style-type: none"> ● Remote Circuit ID; X AP-MAC; SSID; SSID-Type ● Remote Agent; X IDUE-MAC NOTE: The Option 82 string is specific to Alcatel and is not configurable.

4. Click **OK**.

The following table describes the behavior of the DHCP Relay Agent and Option 82 in the OAW-IAP.

Table 43: DHCP Relay and Option 82

DHCP Relay	Option 82	Behavior
Enabled	Enabled	DHCP packet relayed with the ALU-specific Option 82 string
Enabled	Disabled	DHCP packet relayed without the ALU-specific Option 82 string
Disabled	Enabled	DHCP packet not relayed, but broadcast with the ALU-specific Option 82 string
Disabled	Disabled	DHCP packet not relayed, but broadcast without the ALU-specific Option 82 string

In the CLI

To configure a centralized,L2 DHCP profile:

```
(Instant AP) (config)# ip dhcp <profile-name>
(Instant AP) (DHCP Profile <profile-name>)# server-type <centralized>
(Instant AP) (DHCP Profile <profile-name>)# server-vlan <vlan-ID>
(Instant AP) (DHCP Profile <profile-name>)# option82 alu
(Instant AP) (DHCP Profile <profile-name>)# disable-split-tunnel
(Instant AP) (DHCP Profile <profile-name>)# end
(Instant AP)# commit apply
```

To configure a centralized,L3 DHCP profile:

```
(Instant AP) (config)# ip dhcp <profile-name>
(Instant AP) (DHCP Profile <profile-name>)# server-type <centralized>
(Instant AP) (DHCP Profile <profile-name>)# server-vlan <vlan-ID>
(Instant AP) (DHCP Profile <profile-name>)# dhcp-relay
(Instant AP) (DHCP Profile <profile-name>)# dhcp-server <DHCP-relay-server>
(Instant AP) (DHCP Profile <profile-name>)# vlan-ip <DHCP IP address> mask <VLAN mask>
(Instant AP) (DHCP Profile <profile-name>)# end
(Instant AP)# commit apply
```

Configuring the Default DHCP Scope for Client IP Assignment

The DHCP server is a built-in server, used for networks in which clients are assigned IP address by the Virtual Controller. You can customize the DHCP pool subnet and address range to provide simultaneous access to more number of clients. The largest address pool supported is 2048. The default size of the IP address pool is 512.

When the DHCP server is configured and if the **Client IP assignment** parameter for an SSID profile is set to **Virtual Controller Assigned**, the Virtual Controller assigns the IP addresses to the WLAN or wired clients. By default, the OAW-IAP automatically determines a suitable DHCP pool for **Virtual Controller Assigned** networks.

OAW-IAPs typically select the 172.31.98.0/23 subnet. If the IP address of the OAW-IAP is within the 172.31.98.0/23 subnet, the OAW-IAP selects the 10.254.98.0/23 subnet. However, this mechanism does not guarantee that it would avoid all possible conflicts with the wired network. If your wired network uses either 172.31.98.0/23 or 10.254.98.0/23, and you experience problems with the **Virtual Controller Assigned** networks after upgrading to AOS-W Instant 6.2.1.0-3.4 or later, manually configure the DHCP pool by following the steps described in this section.



You can configure a domain name, DNS server, and DHCP server for client IP assignment using the AOS-W Instant UI or CLI.

In the AOS-W Instant UI

1. Navigate to **More > DHCP Server**. The **DHCP Server** tab contents are displayed.

Figure 50 *DHCP Servers Window*

The screenshot shows the 'DHCP Servers' configuration window. At the top, it says 'Virtual Controller Assigned Networks - Default DHCP Scope'. There are four text input fields: 'Domain name:', 'DNS Server(s):', 'Network:', and 'Mask:'. To the right of 'DNS Server(s):' is a 'Lease time:' field with a dropdown menu currently set to 'Minutes'. Below these are three sections for adding scopes: 'Distributed DHCP Scopes (0)', 'Centralized DHCP Scopes (0)', and 'Local DHCP Scopes (0)'. Each section contains a table with columns for 'Name', 'Type', 'VLAN', and 'Branch Subnet' (for distributed), or 'Name', 'Type', and 'VLAN' (for centralized), or 'Name', 'Type', 'VLAN', and 'Network' (for local). Each table has 'New', 'Edit', and 'Delete' buttons below it. At the bottom right of the window are 'OK' and 'Cancel' buttons.

2. Enter the domain name of the client in the **Domain name** text box.
3. Enter the IP addresses of the DNS servers separated by a comma(,) in the **DNS server (s)** text box.
4. Enter the duration of the DHCP lease in the **Lease time** text box. Select any of the following values from the drop-down list next to **Lease time**:
 - **Minutes**—For minutes, specify a value between 2–59.
 - **Hours**—For hours, specify a value between 1–23.
 - **Days** —For days, specify a value between 1–30.The default lease time is 0.
5. Enter the network range for the client IP addresses in the **Network** field. The system generates a network range automatically that is sufficient for 254 addresses. If you want to provide simultaneous access to more number of clients, specify a larger range.
6. Specify the subnet mask details for the network range in the **Mask** text box.
7. Click **OK** to apply the changes.

In the CLI

To configure a DHCP pool:

```
(Instant AP) (config)# ip dhcp pool
(Instant AP) (DHCP)# domain-name <domain>
(Instant AP) (DHCP)# dns-server <DNS-IP-address>
(Instant AP) (DHCP)# lease-time <minutes>
(Instant AP) (DHCP)# subnet <IP-address>
(Instant AP) (DHCP)# subnet-mask <subnet-mask>
```

To view the DHCP database:

```
(Instant AP)# show ip dhcp database
```

DHCP Subnet :192.0.2.0
DHCP Netmask :255.255.255.0
DHCP Lease Time(m) :20
DHCP Domain Name :example.com
DHCP DNS Server :192.0.2.1

This chapter describes time range profiles and the procedure for configuring time based services. It includes the following topics:

- [Time Range Profiles](#)
- [Configuring a Time Range Profile](#)
- [Applying a Time Range Profile to a WLAN SSID](#)
- [Verifying the Configuration](#)

Time Range Profiles

In AOS-W Instant 6.4.3.4-4.2.1.0, OAW-IAPs allow you to enable or disable an SSID for users at a particular time of the day. You can now create a time range profile and assign it to a WLAN SSID, so that user access to the Internet or network is restricted during a specific time period.

OAW-IAPs support the configuration of both absolute and periodic time range profiles. You can configure an absolute time range profile to execute during a specific time frame or create a periodic profile to execute at regular intervals based on the periodicity specified in the configuration.

The following configuration conditions apply to the time-based services:

- Time-based services require an active NTP server connection. OAW-IAPs use the default NTP server for time synchronization. However, the administrators can also configure an NTP server on the OAW-IAP. To verify the time synchronization between the NTP server and the OAW-IAP, execute the **show time-range** command and check if the time on the NTP server is in synchronization with the local time. For more information on NTP server configuration, see [NTP Server](#).
- For a time range profile configured to **enable** the SSID on the OAW-IAP:
 - When the timer starts, if the current time is greater than the start time and lesser than the end time, the SSID will be brought UP. If the SSID is already UP, then there is no effect on the SSID.
 - When the timer ends, If the current time is greater than the end time, the SSID is brought DOWN. If the SSID is already DOWN, then there is no effect on the SSID.
- For a time range profile configured to **disable** the SSID on the OAW-IAP:
 - When the timer starts, if the current time is greater than the start time and lesser than the end time, the SSID will be brought DOWN. If the SSID is already DOWN, then there is no effect on the SSID.
 - When the timer ends, If the current time is greater than the end time, the SSID is brought UP. If the SSID is already UP, then there is no effect on the SSID.

Configuring a Time Range Profile

You can create Time Range Profiles using the AOS-W Instant UI or CLI.

In the AOS-W Instant UI

1. Navigate to **System > Show advanced options > Time Based Services**.
2. Click **New** under Time Range Profiles. The **New Profile** window for creating time range profiles is displayed. Configure the parameters listed in the following table:

Table 44: Time Range Profile Configuration Parameters

Parameter	Description
Name	Specify a name for the time range profile.
Type	Select the type of time range profile. Periodic — When configured, the state of the OAW-IAP changes based on the time range configured in the profile. Absolute —When configured, the state of the OAW-IAP changes during a specific date / day and time.
Period Type	For periodic time range profiles, specify a periodic interval (day / weekday / weekend / daily) at which the time range profile must be applied.
Start Day and End Day	For absolute time range profiles, specify the start day and end day to configure a specific time period during which the time range profile is applied. NOTE: The year selected for the Start Day and End Day cannot exceed the year 2037.
Start Time	Select the start time for the time range profile in the hh:mm format.
End Time	Choose the end time for the time range profile in hh:mm format.

3. Click **OK**.

In the CLI:

To create an absolute time range profile:

```
(Instant AP) (config)# time-range <name> absolute start <startday> <starttime> end <endday>
<endtime>
(Instant AP) (config)# end
(Instant AP)# commit apply
```

To configure a periodic time range profile:

```
(Instant AP) (config)# time-range <name> periodic {<startday>| daily| weekday| weekend}
<starttime> to <endtime>
(Instant AP) (config)# end
(Instant AP)# commit apply
```

Applying a Time Range Profile to a WLAN SSID

To apply a time range profile to a WLAN SSID in the AOS-W Instant UI:

1. Navigate to the WLAN SSID profile configuration wizard (click **Network>New** or **Network>** or select the WLAN SSID> click **edit**).
2. Click **Show advanced options**.
3. Click **Edit**, select a time range profile from the list and select a value from the **Status** drop-down list, and then click **OK**.
 - When a time range profile is enabled on SSID, the SSID is made available to the users for the configured time range. For example, if the specified time range is 12:00 to 13:00, the SSID becomes available only between 12 PM to 1 PM on a given day.
 - If a time range is disabled, the SSID becomes unavailable for the configured time range. For example, if configured time-range is 14:00 to 17:00, the SSID is made unavailable from 2 PM to 5 PM on a given day.

4. Click **Next** and then click **Finish**.



If the SSID has two time profiles enabled with an overlapping duration, the time range profile will be executed as per the configuration conditions described earlier in this chapter. For example, if profile1 has 9AM-12PM as the duration and the time-range configured for profile2 is 10AM-11AM and both are enabled on the SSID, the SSID becomes available only between 9AM-11AM.

In the CLI

To enable a time profile on an SSID:

```
(Instant AP) (config)# wlan ssid-profile <name>
(Instant AP) (SSID Profile "<name>")# time-range <name> enable
(Instant AP) (SSID Profile "<name>")# end
(Instant AP)# commit apply
```

To disable a time profile on an SSID:

```
(Instant AP) (config)# wlan ssid-profile <name>
(Instant AP) (SSID Profile "<name>")# time-range <name> disable
(Instant AP) (SSID Profile "<name>")# end
(Instant AP)# commit apply
```

Verifying the Configuration

To view the time range profiles created on an OAW-IAP, execute the following command:

```
(Instant AP) (config) # show time-range
```

Time Range Summary

Profile Name	Type	Start Day	Start Time	End Day	End Time	Valid
test	Periodic	daily	13:00	-	14:00	No
test1	Absolute	11/17/2015	10:00	11/24/2015	17:00	No
Lunchbreak	Periodic	weekday	12:00	-	13:00	No
Lunchbreak1	Periodic	daily	12:00	-	13:00	No

To verify if the time range profile is enabled on an SSID:

```
(Instant AP) (config) # show time-profile
```

Time Range SSID Profile

Time Profile Name	SSID profile Name	Enable/Disable
Lunch Break	Test123	Enable

Example

The following example creates an absolute time range profile :

```
(Instant AP) (config) # time-range timep1 absolute start 10/20/2013 10:40 end 10/20/2015 10:50
```

The following example creates a periodic time range profile that executes on the specified day of the week:

```
(Instant AP) (config) # time-range timep2 periodic monday 10:40 to tuesday 10:50
```

The following example creates a periodic time range profile that executes daily:

```
(Instant AP) (config) # time-range testshs12 periodic daily 10:20 to 10:35
```

The following example creates a periodic time range profile that executes during the weekday:

```
(Instant AP) (config) # time-range timep3 periodic weekday 10:20 to 10:35
```

The following example creates a periodic time range profile that executes during the weekend:

```
(Instant AP) (config) # time-range timep4 periodic weekend 10:20 to 10:30
```

The following example removes the time range configuration:

```
(Instant AP) (config) # no time-range testshs12
```

This chapter describes the procedure for configuring Dynamic DNS (DDNS) on OAW-IAPs and their clients. It includes the following topics:

- [Enabling Dynamic DNS](#)
- [Configuring Dynamic DNS Updates for Clients](#)
- [Verifying the Configuration](#)

Enabling Dynamic DNS

Starting from AOS-W Instant 6.4.4.4-4.2.3.0, OAW-IAPs support the dynamic dns feature which enables updating the DNS records of the OAW-IAP and the clients connected to it. In a scenario, where the public IP address is dynamically handed to the OAW-IAP by the ISP, there are instances when the client loses remote connectivity to the OAW-IAP when there is a change in the IP address. Similarly, in case of OAW-IAP clients, where the OAW-IAP acts as a DHCP server, the host becomes unreachable when the dynamically assigned IP address is changed. The dynamic dns feature eliminates these issues by configuring a domain name, thus providing an uniform approach to access the OAW-IAP or the clients. The IP address of the dynamic dns client is mapped to the domain name and this gets automatically updated each time the IP address is changed.

You can enable Dynamic DNS using the AOS-W Instant UI or CLI.

In the AOS-W Instant UI

1. Navigate to **Services > Dynamic DNS**.
2. Select the **Enable Dynamic DNS** checkbox.

Table 45: Dynamic DNS Configuration Parameters

Parameter	Description	
Key	Configures a TSIG shared secret key to secure the dynamic updates. The following algorithm names are supported: <ul style="list-style-type: none"> • hmac-md5 (used by default if algo-name is not specified) • hmac-sha1 • hmac-sha256 NOTE: When a key is configured, the update is successful only if OAW-IAP and DNS server clocks are in sync.	hmac-sha1:arubaddns: 16YuLPdH21rQ6PuK9udsVLtJw3Y=
Server IP	Enter the Server IP address of the DNS server to which the client updates are sent.	10.17.132.85
Interval	Specify the time interval (in secs) at which the DNS updates are to be synced to the server. The default time interval is 12 hours, minimum time interval is 15 minutes and maximum time interval is 100 days.	900

3. Click **OK**.

In the CLI:

To enable dynamic dns on an OAW-IAP

```
(Instant AP) (config)# dynamic-dns-ap
(Instant AP) (config)# end
(Instant AP)# commit apply
```

To configure a TSIG key and Server IP address:

```
(Instant AP) (config)# dynamic-dns-ap key <algo-name:keyname:keystring>
(Instant AP) (config)# dynamic-dns-ap server <ddns_server>
(Instant AP) (config)# end
(Instant AP)# commit apply
```

To configure a time interval:

```
(Instant AP) (config)# dynamic-dns-interval <ddns_interval>
(Instant AP) (config)# end
(Instant AP)# commit apply
```

Configuring Dynamic DNS Updates for Clients

You can enable DDNS updates when creating or editing a DHCP scope for **Distributed, L3** clients. Once enabled, the DDNS updates of the clients are periodically sent to the DNS server configured in the DHCP profile during the specified time interval. If there is no DNS server configured in the DHCP profile, the client DNS updates will be dropped. The DDNS updates are secured by using TSIG shared secret keys, when communicating between the client and the server. For more information, see [Configuring Distributed DHCP Scopes on page 217](#)

To enable DDNS for clients in the AOS-W Instant UI:

1. Navigate to **More>DHCP Servers**, choose the Distributed, L3 DHCP Scope under **Distributed DHCP Scopes** and click **Edit**.
2. Select the **Dynamic DNS** checkbox.
3. Enter the TSIG shared secret **key**.
4. Click **Next** and then click **Finish**.

In the CLI

To enable DDNS for OAW-IAP clients:

```
(Instant AP) (config)# ip dhcp <profile name>
(Instant AP) (DHCP profile "<name>")# dynamic-dns
(Instant AP) (DHCP profile "<name>")# dynamic-dns key <algo-name:keyname:keystring>
(Instant AP) (DHCP Profile "<name>")# end
(Instant AP)# commit apply
```

Verifying the Configuration

To view the DDNS status on an OAW-IAP, execute the following command:

```
(Instant AP)# show ddns
DDNS Enabled      :Enabled
DDNS Server       :10.1.1.23
DDNS Key          :dynamic-dns delete 10.17.132.7 test.ddns host-anand 10.17.132.85 key hmac-
sha1:arubaddns:16YuLPdH21rQ6PuK9udsVLtJw3Y=
DDNS Interval     :900
```

To view the list of DDNS clients, execute the following command:

```
(Instant AP)# show ddns clients
DDNS Client List
-----
Host Name          Domain Name  IP Address    DHCP profile name  Success Count  Failure Count
-----
iap1-ddns-home    test.ddns    192.192.192.17  None                16             22
132-13-Auto-PC    test.ddns    192.168.99.18  DistL3              9              3
132-14-Auto-PC    test.ddns    192.168.99.4   DistL3              2              0

Last updated      Last update status
-----
7 seconds ago     Success
7 seconds ago     Success
7 seconds ago     Success
```

DHCP profile name is None for the Master OAW-IAP update sent.

The **show running-config** command displays the **Key** in the encrypted format.

You can also configure dynamic dns on an OAW-IAP or clients using the privileged exec mode in the CLI. For more information, see the **show ddns clients** command in the *AOS-W Instant 6.4.4.4-4.2.3.0 CLI Reference Guide*.



This chapter describes the following VPN configuration procedures:

- [Understanding VPN Features on page 232](#)
- [Configuring a Tunnel from an OAW-IAP to a Mobility Controller on page 233](#)
- [Configuring Routing Profiles on page 244](#)

Understanding VPN Features

As OAW-IAPs use a Virtual Controller architecture, the OAW-IAP network does not require a physical switch to provide the configured WLAN services. However, a physical switch is required for terminating Virtual Private Networks (VPN) tunnels from the OAW-IAP networks at branch locations to datacenters, where the Alcatel-Lucent switch acts as a VPN concentrator.

When the VPN is configured, the OAW-IAP acting as the Virtual Controller creates a VPN tunnel to an OmniAccess WLAN Switch in your corporate office. The switch acts as a VPN end-point and does not supply the OAW-IAP with any configuration.

The VPN features are recommended for:

- Enterprises with many branches that do not have a dedicated VPN connection to the corporate office.
- Branch offices that require multiple APs.
- Individuals working from home, connecting to the VPN.

The survivability feature of OAW-IAPs with the VPN connectivity of OAW-IAPs allows you to provide corporate connectivity on non-corporate networks.

Supported VPN Protocols

AOS-W Instant support the following VPN protocols for remote access:

Table 46: *VPN Protocols*

VPN Protocol	Description
Alcatel-Lucent IPsec	<p>IPsec is a protocol suite that secures IP communications by authenticating and encrypting each IP packet of a communication session.</p> <p>You can configure an IPsec tunnel to ensure that the data flow between the networks is encrypted. However, you can configure a split-tunnel to encrypt only the corporate traffic.</p> <p>When IPsec is configured, ensure that you add the OAW-IAP MAC addresses to the whitelist database stored on the switch or an external server. IPsec supports Local, L2, and L3 modes of IAP-VPN operations.</p> <p>NOTE: The OAW-IAPs support IPsec only with Alcatel-Lucent Switches.</p>
Layer-2 (L2) GRE	<p>Generic Routing Encapsulation (GRE) is a tunnel protocol for encapsulating multicast, broadcast, and L2 packets between a GRE-capable device and an end-point. OAW-IAPs support the configuration of L2 GRE (Ethernet over GRE) tunnel with an Alcatel-Lucent Switch to encapsulate the packets sent and received by the OAW-IAP.</p> <p>You can use the GRE configuration for L2 deployments when there is no encryption requirement between the OAW-IAP and switch for client traffic.</p> <p>OAW-IAPs support two types of GRE configuration:</p> <ul style="list-style-type: none">• Manual GRE—The manual GRE configuration sends unencrypted client traffic with an additional GRE header and does not support failover. When manual GRE is configured on the OAW-IAP, ensure that the GRE tunnel settings are enabled on the switch.• Alcatel-Lucent GRE—With Alcatel-Lucent GRE, no configuration on the switch is required except for adding the OAW-IAP MAC addresses to the whitelist database stored on the switch or an external server. Alcatel-Lucent GRE reduces manual configuration when Per-AP tunnel configuration is required and supports failover between two GRE end-points. <p>NOTE: OAW-IAPs support manual and Alcatel-Lucent GRE configuration only for L2 mode of operations. Alcatel-Lucent GRE configuration is supported only on Alcatel-Lucent Switches.</p>
L2TP	<p>The Layer 2 Tunneling Protocol version 3 (L2TPv3) feature allows OAW-IAP to act as L2TP Access Concentrator (LAC) and tunnel all wireless clients L2 traffic from AP to L2TP Network Server (LNS). In a centralized L2 model, the VLAN on the corporate side are extended to remote branch sites. Wireless clients associated with OAW-IAP gets the IP address from the DHCP server running on LNS. For this, AP has to transparently allow DHCP transactions through the L2TPv3 tunnel.</p>

Configuring a Tunnel from an OAW-IAP to a Mobility Controller

OAW-IAP supports the configuration of tunneling protocols such as Generic Routing Encapsulation (GRE), IPsec, and L2TPv3. This section describes the procedure for configuring VPN host settings on an OAW-IAP to enable communication with a switch in a remote location:

- [Configuring an IPsec Tunnel on page 234](#)
- [Configuring an L2-GRE Tunnel on page 235](#)
- [Configuring an L2TPv3 Tunnel on page 238](#)

Configuring an IPsec Tunnel

An IPsec tunnel is configured to ensure that the data flow between the networks is encrypted. When configured, the IPsec tunnel to the switch secures corporate data.

You can configure an IPsec tunnel from Virtual Controller using the AOS-W Instant UI or CLI.

In the AOS-W Instant UI

To configure a tunnel using the IPsec protocol:

1. Click the **More > VPN** link at the top right corner of the AOS-W Instant UI. The **Tunneling** window is displayed.
2. Select **Aruba IPsec** from the **Protocol** drop-down list.
3. Enter the IP address or fully qualified domain name (FQDN) for the primary VPN/IPsec endpoint in the **Primary host** field.
4. Enter the IP address or FQDN for the backup VPN/IPsec endpoint in the **Backup host** field. This entry is optional. When you specify the primary and backup host details, the other fields are displayed.
5. Specify the following parameters. A sample configuration is shown in [Figure 51](#).
 - a. To allow the VPN tunnel to switch back to the primary host when it becomes available again, select **Enabled** from the **Preemption** drop-down list. This step is optional.
 - b. If **Preemption** is enabled, specify a value in seconds for **Hold time**. When preemption is enabled and the primary host comes up, the VPN tunnel switches back to the primary host after the specified hold-time. The default value for **Hold time** is 600 seconds.
 - c. To allow the OAW-IAP to create a backup VPN tunnel to the switch along with the primary tunnel, and maintain both the primary and backup tunnels separately, select **Enabled** from the **Fast failover** drop-down list. When fast failover is enabled and if the primary tunnel fails, the OAW-IAP can switch the data stream to the backup tunnel. This reduces the total failover time to less than one minute.
 - d. To disconnect all wired and wireless users when the system switches during VPN tunnel transition from primary to backup and backup to primary, set **Reconnect user on failover** to **Enabled**.
 - e. To configure an interval during which the wired and wireless users are disconnected during a VPN tunnel switch, specify a value in seconds for **Reconnect time on failover** within a range of 30—900 seconds. By default, the reconnection duration is set to 60 seconds.
 - f. Specify a value in seconds for **Secs between test packets**. Based on the configured frequency, the OAW-IAP can verify if an active VPN connection is available. The default value is 5 seconds, which means that the OAW-IAP sends one packet to the switch every 5 seconds.
 - g. Enter a value for **Max allowed test packet loss**, to define a number for lost packets, after which the OAW-IAP can determine that the VPN connection is unavailable. The default value is 2.

Figure 51 IPsec Configuration

The screenshot shows the 'Tunneling' configuration window with two tabs: '1 Controller' (active) and '2 Routing'. Under the 'Controller' tab, the 'IPsec' configuration is visible. The fields are as follows:

Protocol:	Aruba IPsec
Primary host:	10.0.0.1
Backup host:	10.0.0.2
Preemption:	Enabled
Hold time:	600 sec.
Fast failover:	Enabled
Reconnect User On Failover:	Enabled
Reconnect Time On Failover:	60 sec.
Secs between test packets:	5
Max allowed test packet loss:	2

At the bottom right of the window, there are 'Next' and 'Cancel' buttons.

- Click **Next** to create routing profiles. When the IPsec tunnel configuration is completed, the packets that are sent from and received by an OAW-IAP are encrypted.

In the CLI

To configure an IPsec VPN tunnel:

```
(Instant AP) (config)# vpn primary <name>
(Instant AP) (config)# vpn backup <name>
(Instant AP) (config)# vpn fast-failover
(Instant AP) (config)# vpn hold-time <seconds>
(Instant AP) (config)# vpn preemption
(Instant AP) (config)# vpn monitor-pkt-send-freq <frequency>
(Instant AP) (config)# vpn monitor-pkt-lost-cnt <count>
(Instant AP) (config)# vpn reconnect-user-on-failover
(Instant AP) (config)# vpn reconnect-time-on-failover <down_time>
(Instant AP) (config)# end
(Instant AP)# commit apply
```

Example

```
(Instant AP) (config)# vpn primary 192.0.2.18
(Instant AP) (config)# vpn backup 192.0.2.18
(Instant AP) (config)# vpn fast-failover
(Instant AP) (config)# vpn preemption

(Instant AP) (config)# ip dhcp distl2
(Instant AP) (DHCP Profile "distL2")# server-type Distributed,L2
(Instant AP) (DHCP Profile "distL2")# server-vlan 2
(Instant AP) (DHCP Profile "distL2")# ip-range 10.15.205.0 10.15.205.255
(Instant AP) (DHCP Profile "distL2")# subnet-mask 255.255.255.0
(Instant AP) (DHCP Profile "distL2")# lease-time 86400
(Instant AP) (DHCP Profile "distL2")# default-router 10.15.205.254
(Instant AP) (DHCP Profile "distL2")# dns-server 10.13.6.110,10.1.1.50
(Instant AP) (DHCP Profile "distL2")# domain-name alcatel-lucent.com
(Instant AP) (DHCP Profile "distL2")# client-count 5

(Instant AP) (config)# ip dhcp local
(Instant AP) (DHCP Profile "local")# server-type Local
(Instant AP) (DHCP Profile "local")# server-vlan 200
(Instant AP) (DHCP Profile "local")# subnet 172.16.200.1
(Instant AP) (DHCP Profile "local")# subnet-mask 255.255.255.0
(Instant AP) (DHCP Profile "local")# lease-time 86400
(Instant AP) (DHCP Profile "local")# dns-server 10.13.6.110,10.1.1.50
(Instant AP) (DHCP Profile "local")# domain-name alcatel-lucent.com
```

To view VPN configuration:

```
Instant Access Point# show vpn config
```

Configuring an L2-GRE Tunnel

This section describes the following procedures:

- [Configuring Manual GRE Parameters](#)
- [Configuring Alcatel-Lucent GRE Parameters](#)

Configuring Manual GRE Parameters

To configure a GRE tunnel between the OAW-IAP and switch using either the Virtual Controller IP or the OAW-IAP IP, based on the following OAW-IAP settings:

- If a Virtual Controller IP is configured and if **Per-AP tunnel** is disabled, use Virtual Controller IP.
- If a Virtual Controller IP is not configured or if **Per-AP tunnel** is enabled, use the OAW-IAP IP.

For information on the GRE tunnel configuration on the switch, see *AOS-W Instant User Guide*.

In the AOS-W Instant UI

To configure a GRE tunnel in the UI:

1. Click the **More > VPN** link at the top right corner of the AOS-W Instant UI. The **Tunneling** window is displayed.
2. Select **Manual GRE** from the **Protocol** drop-down list.
3. Specify the following parameters. A sample configuration is shown in [Figure 52](#).
 - a. Enter an IP address or the FQDN for the main VPN/GRE endpoint.
 - b. Enter a value for the GRE type parameter.
 - c. Select **Enabled** or **Disabled** from the **Per-AP tunnel** drop-down list. Enable this option to create a GRE tunnel from each OAW-IAP to the VPN/GRE Endpoint rather than the tunnels created just from the master OAW-IAP. When enabled, the traffic to the corporate network is sent through a Layer-2 GRE tunnel from the OAW-IAP itself and need not be forwarded through the master OAW-IAP.



By default, the **Per-AP tunnel** option is disabled.

Figure 52 Manual GRE Configuration

The screenshot shows a web-based configuration window titled "Tunneling" with a "Help" link in the top right corner. The window has two tabs: "1 Controller" (active) and "2 Routing". Under the "Controller" tab, there are four configuration fields: "Protocol" is set to "Manual GRE" (dropdown), "Host" is "192.0.2.15" (text input), "GRE type" is "1" (text input), and "Per-AP tunnel" is "Enabled" (dropdown). At the bottom right, there are "Next" and "Cancel" buttons.

4. Click **Next** to continue. When the GRE tunnel configuration is completed on both the OAW-IAP and Switch, the packets sent from and received by an OAW-IAP are encapsulated, but not encrypted.

In the CLI

To configure a manual GRE VPN tunnel:

```
(Instant AP) (config)# gre primary <name>
(Instant AP) (config)# gre type <type>
(Instant AP) (config)# gre per-ap-tunnel
(Instant AP) (config)# end
(Instant AP)# commit apply
```

To view VPN configuration details:

```
Instant Access Point# show vpn config
```

To configure GRE tunnel on the switch:

```
(host) (config)# interface tunnel <Number>
(host) (config-tunnel)# description <Description>
(host) (config-tunnel)# tunnel mode gre <ID>
```

```
(host) (config-tunnel)# tunnel source <controller-IP>
(host) (config-tunnel)# tunnel destination <AP-IP>
(host) (config-tunnel)# trusted
(host) (config-tunnel)# tunnel vlan <allowed-VLAN>
```

Configuring Alcatel-Lucent GRE Parameters

The automatic GRE feature uses the IPsec connection between the OAW-IAP and switch to send the control information for setting up a GRE tunnel. When automatic GRE configuration is enabled, a single IPsec tunnel between the OAW-IAP cluster and the switch, and one or several GRE tunnels are created based on the Per-AP tunnel configuration on the OAW-IAP. For Alcatel-Lucent GRE, no manual configuration is required on the switch to create the GRE tunnel.



Alcatel-LucentGRE is supported only on Alcatel-Lucent switches running AOS-W Instant 6.4.x.x or later versions.

In the AOS-W Instant UI

To configure Alcatel-Lucent GRE in the UI:

1. Click the **More > VPN** link at the top right corner of the AOS-W Instant UI. The **Tunneling** window is displayed.
2. Select **Aruba GRE** from the **Protocol** drop-down list.
3. Enter the IP address or FQDN for the main VPN/IPsec endpoint in the **Primary host** field.
4. Enter the IP address or FQDN for the backup VPN/IPsec endpoint in the **Backup host** field. This entry is optional. When you enter the primary host IP address and backup host IP address, other fields are displayed.
5. Specify the following parameters. A sample configuration is shown in [Figure 52](#).
 - a. To allow the VPN tunnel to switch back to the primary host when it becomes available again, select **Enabled** from the **Preemption** drop-down list. This step is optional.
 - b. If **Preemption** is enabled, specify a value in seconds for **Hold time**. When preemption is enabled and the primary host comes up, the VPN tunnel switches to the primary host after the specified hold time. The default value for **Hold time** is 600 seconds.
 - c. To allow the OAW-IAP to create a backup VPN tunnel to the switch along with the primary tunnel, and maintain both the primary and backup tunnels separately, select **Enabled** or **Disabled** from the **Fast failover** drop-down list. If the primary tunnel fails, the OAW-IAP can switch the data stream to the backup tunnel. This reduces the total failover time to less than one minute.
 - d. To disconnect all wired and wireless users when the system switches during VPN tunnel transition from primary to backup and backup to primary, set **Reconnect user on failover** to **Enabled**.
 - e. To configure an interval for which wired and wireless users are disconnected during a VPN tunnel switch, specify a value in seconds for **Reconnect time on failover** within the range of 30—900 seconds. By default, the reconnection duration is set to 60 seconds.
 - f. Specify a value in seconds for **Secs between test packets**. Based on the configured frequency, the OAW-IAP can verify if an active VPN connection is available. The default value is 5 seconds, which means that the OAW-IAP sends one packet to the switch every 5 seconds.
 - g. Enter a value for **Max allowed test packet loss**, to define a number for lost packets, after which the OAW-IAP can determine that the VPN connection is unavailable. The default value is 2.
 - h. Select **Enabled** or **Disabled** from the **Per-AP tunnel** drop-down list. The administrator can enable this option to create a GRE tunnel from each OAW-IAP to the VPN/GRE Endpoint rather than the tunnels created just from the master OAW-IAP. When enabled, the traffic to the corporate network is sent through a Layer-2 GRE tunnel from the OAW-IAP itself and need not be forwarded through the master OAW-IAP.

Figure 53 Alcatel-Lucent GRE Configuration

The screenshot shows a web-based configuration interface for GRE tunneling. The interface has a blue header with 'Tunneling' and a 'Help' link. Below the header, there are two tabs: '1 Controller' (highlighted in green) and '2 Routing'. The 'Controller' section contains the following configuration fields:

- Protocol: Aruba GRE (dropdown)
- Primary host: 192.0.2.2 (text input)
- Backup host: 192.0.2.4 (text input)
- Preemption: Enabled (dropdown)
- Hold time: 600 sec. (text input)
- Fast failover: Enabled (dropdown)
- Reconnect user on failover: Enabled (dropdown)
- Reconnect time on failover: 60 sec. (text input)
- Secs between test packets: 5 (text input)
- Max allowed test packet loss: 2 (text input)
- Per-AP tunnel: Enabled (dropdown)

At the bottom right of the configuration area, there are two buttons: 'Next' and 'Cancel'.

6. Click **Next** to continue.

In the CLI

To enable automatic configuration of the GRE tunnel:

```
(Instant AP) (config) # vpn gre-outside
(Instant AP) (config) # vpn primary <name/IP-address>
(Instant AP) (config) # vpn backup <<name/IP-address>>
(Instant AP) (config) # vpn fast-failover
(Instant AP) (config) # vpn hold-time <seconds>
(Instant AP) (config) # vpn preemption
(Instant AP) (config) # vpn monitor-pkt-send-freq <frequency>
(Instant AP) (config) # vpn monitor-pkt-lost-cnt <count>
(Instant AP) (config) # vpn reconnect-user-on-failover
(Instant AP) (config) # vpn reconnect-time-on-failover <down_time>
(Instant AP) (config) # end
(Instant AP) # commit apply
```

To view VPN configuration details:

```
(Instant AP) # show vpn config
```

Configuring an L2TPv3 Tunnel

L2TPv3 supports the following:

- AOS-W Instant supports tunnel and session configuration, and uses Control Message Authentication (RFC 3931) for tunnel and session establishment. Each L2TPv3 tunnel supports one data connection and this connection is termed as an L2TPv3 session.
- Each OAW-IAP supports tunneling over UDP only.

- If the primary LNS is down, it fails over to the backup LNS. L2TPv3 has one tunnel profile and under this, one primary peer and a backup peer are configured. If the primary tunnel creation fails or if the primary tunnel gets deleted, the backup starts. The following two failover modes are supported:
 - Preemptive: In this mode, if the primary comes up when the backup is active, the backup tunnel is deleted and the primary tunnel resumes as an active tunnel. If you configure the tunnel to be preemptive, and when the primary tunnel goes down, it starts the persistence timer which tries to bring up the primary tunnel.
 - Non-Preemptive: In this mode, when the backup tunnel is established after the primary tunnel goes down, it does not make the primary tunnel active again.
- L2TPv3 is not supported on OAW-IAP205 devices.

You can configure an L2TPv3 tunnel and session profiles through the AOS-W Instant UI or CLI.

In the AOS-W Instant UI

1. Click the **More > VPN** link at the top right corner of the AOS-W Instant UI. The **Tunneling** window is displayed.

Figure 54 L3TPv3 Tunneling

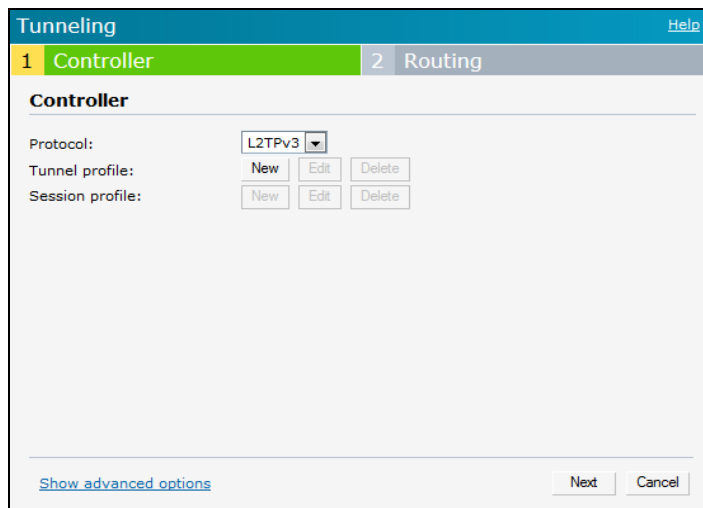

2. Select **L2TPv3** from the Protocol drop-down list.
3. Configure the tunnel profile:
 - a. Enter the tunnel name to be used for tunnel creation.

Figure 55 Tunnel Configuration

Tunnel Configuration

Primary Peer address: 10.0.0.63

Backup Peer address: 10.0.0.65

Peer UDP port: 3000

Local UDP port: 1701

Hello interval: 150 sec.

Message digest type: MD5

Shared key:

Checksum: Disabled

Failover mode: non-Preemptive

Failover retry interval: 80 sec.

Failover retry count: 5

MTU: 1570

OK Cancel

- b. Enter the primary server IP address.
 - c. Enter the remote end backup tunnel IP address. This is an optional field and is required only when backup server is configured.
 - d. Enter the remote end UDP port number. The default value is 1701.
 - e. Enter the interval at which the hello packets are sent through the tunnel. The default value is 60 seconds.
 - f. Select the message digest as MD5 or SHA used for message authentication.
 - g. Enter a shared key for the message digest. This key should match with the tunnel end point shared key.
 - h. If required, select the failover mode as Primary or Backup (when the backup server is available).
 - i. Specify a value for the tunnel MTU value if required. The default value is 1460.
 - j. Click **OK**.
4. Configure the session profile:
- a. Enter the session name to be used for session creation.

Figure 56 Session Configuration

Session Configuration

Profile name:

Tunnel profile name: test

Tunnel IP address:

Tunnel Netmask:

Tunnel VLAN:

Cookie Len: 0

Cookie:

Remote end ID:

Default I2 specific sublayer:

OK Cancel

- b. Enter the tunnel profile name where the session will be associated.
- c. Configure the tunnel IP address with the corresponding network mask and VLAN ID. This is required to reach an AP from a corporate network. For example, SNMP polling.

- d. Select the cookie length and enter a cookie value corresponding to the length. By default, the cookie length is not set.
 - e. Specify the remote end ID.
 - f. If required, enable default l2 specific sublayer in the L2TP session.
 - g. Click **OK**.
5. Click **Next** to continue.

In the CLI

To configure an L2TPv3 VPN tunnel profile:

```
(Instant AP) (config)# l2tpv3 tunnel <l2tpv3_tunnel_profile>
(Instant AP) (L2TPv3 Tunnel Profile <l2tpv3_tunnel_profile>)# primary peer-address <peer_ip_
addr_tunnel>
(Instant AP) (L2TPv3 Tunnel Profile <l2tpv3_tunnel_profile>)# backup peer-address <peer_ip_
addr_tunnel>
(Instant AP) (L2TPv3 Tunnel Profile <l2tpv3_tunnel_profile>)# checksum
(Instant AP) (L2TPv3 Tunnel Profile <l2tpv3_tunnel_profile>)# failover-mode <mode>
(Instant AP) (L2TPv3 Tunnel Profile <l2tpv3_tunnel_profile>)# failover-retry-count <retry_
count>
(Instant AP) (L2TPv3 Tunnel Profile <l2tpv3_tunnel_profile>)# failover-retry-interval
<interval_in_sec>
(Instant AP) (L2TPv3 Tunnel Profile <l2tpv3_tunnel_profile>)# hello-timeout <interval_in_sec>
(Instant AP) (L2TPv3 Tunnel Profile <l2tpv3_tunnel_profile>)# local-port <local_udp_port>
(Instant AP) (L2TPv3 Tunnel Profile <l2tpv3_tunnel_profile>)# peer-port <peer_udp_port>
(Instant AP) (L2TPv3 Tunnel Profile <l2tpv3_tunnel_profile>)# message-digest-type <digest_
algo>
(Instant AP) (L2TPv3 Tunnel Profile <l2tpv3_tunnel_profile>)# secret-key <key>
(Instant AP) (L2TPv3 Tunnel Profile <l2tpv3_tunnel_profile>)# mtu <tunnel_MTU>
(Instant AP) (L2TPv3 Tunnel Profile <l2tpv3_tunnel_profile>)# end
(Instant AP)# commit apply
```

To configure an L2TPv3 session profile:

```
(Instant AP) (config)# l2tpv3 session <l2tpv3_session_profile>
(Instant AP) (L2TPv3 Tunnel Profile <l2tpv3_session_profile>)# cookie len <len_of_cookie>
value <cookie_val>
(Instant AP) (L2TPv3 Tunnel Profile <l2tpv3_session_profile>)# l2tpv3 tunnel <l2tpv3_tunnel_
name_to_associate>
(Instant AP) (L2TPv3 Tunnel Profile <l2tpv3_session_profile>)# tunnel-ip <local_ip_addr_
tunnel> mask <tunnel_mask> vlan <tunnel_mgmt_vlan>
(Instant AP) (L2TPv3 Tunnel Profile <l2tpv3_session_profile>)# default-l2-specific-sublayer
(Instant AP) (L2TPv3 Tunnel Profile <l2tpv3_session_profile>)# end
(Instant AP)# commit apply
```

Example

```
(Instant AP) (config)# l2tpv3 tunnel test_tunnel
(Instant AP) (L2TPv3 Tunnel Profile "test_tunnel")# primary peer-address 10.0.0.65
(Instant AP) (L2TPv3 Tunnel Profile "test_tunnel")# backup peer-address 10.0.0.63
(Instant AP) (L2TPv3 Tunnel Profile "test_tunnel")# no checksum
(Instant AP) (L2TPv3 Tunnel Profile "test_tunnel")# failover-mode non-preemptive
(Instant AP) (L2TPv3 Tunnel Profile "test_tunnel")# failover-retry-count 5
(Instant AP) (L2TPv3 Tunnel Profile "test_tunnel")# failover-retry-interval 80
(Instant AP) (L2TPv3 Tunnel Profile "test_tunnel")# hello-timeout 150
(Instant AP) (L2TPv3 Tunnel Profile "test_tunnel")# mtu 1570
(Instant AP) (L2TPv3 Tunnel Profile "test_tunnel")# peer-port 3000
(Instant AP) (L2TPv3 Tunnel Profile "test_tunnel")# secret-key test123
(Instant AP) (L2TPv3 Tunnel Profile "test_tunnel")# end
(Instant AP) # commit apply

(Instant AP) (config) # l2tpv3 session test_session
```

```
(Instant AP) (L2TPv3 Session Profile "test_session")# cookie len 4 value 12345678
(Instant AP) (L2TPv3 Session Profile "test_session")# l2tpv3 tunnel test_tunnel
(Instant AP) (L2TPv3 Session Profile "test_session")# tunnel-ip 1.1.1.1 mask 255.255.255.0 vlan
5
(Instant AP) (L2TPv3 Tunnel Profile "test_tunnel")# end
(Instant AP)# commit apply
```

To view L2TPv3 configuration:

```
(Instant AP)# show l2tpv3 config
L2TPV3 Tunnel configuration
-----
Tunnel Profile Primary Peer Backup Peer Peer UDP Port Local UDP Port Hello Interval Host Name
MTU Message Digest Type secret Key Failover Mode Failover Retry Count Retry Interval Checksum
-----
-
test_tunnel 10.0.0.63 10.0.0.65 3000 1701 150 Instant-C4:42:98 1570 MD5
625beed39fa4ff3424edb3082ede48fa non-preemptive 5 80 Disabled
L2TPV3 Session configuration
-----
Session Name Tunnel Name Local tunnel IP Tunnel Mask Tunnel Vlan Session Cookie Length Session
Cookie Session Remote End ID
-----
test_session 1.1.1.1 255.255.255.0 5 0 0 0
```

To view L2TPv3 global configuration:

```
(Instant AP)# show l2tpv3 global parameter

L2TPV3 Global configuration
-----
Host Name
-----
Instant-C4:42:98
```

To view L2TPV3 session status:

```
(Instant AP)# show l2tpv3 session status

Session 1821009927 on tunnel 858508253:-
type: LAC Incoming Call, state: ESTABLISHED
created at: Jul 2 04:58:45 2013
administrative name: 'test_session' (primary)
created by admin: YES, peer session id: 12382
session profile name: test_session_primary
data sequencing required: OFF
use data sequence numbers: OFF
Peer configuration data:-
data sequencing required: OFF
framing types:
data rx packets: 16, rx bytes: 1560, rx errors: 0 rx cookie error 0
data tx packets: 6, tx bytes: 588, tx errors: 0
```

To view L2TPV3 tunnel status:

```
(Instant AP)# show l2tpv3 tunnel status

Tunnel 858508253, from 10.13.11.29 to 10.13.11.157:-
state: ESTABLISHED
created at: Jul 2 04:58:25 2013
administrative name: 'test_tunnel' (primary)
```

```

created by admin: YES, tunnel mode: LAC, persist: YES
local host name: Instant-C4:42:98
peer tunnel id: 1842732147, host name: arubal600pop636635.hsbtst2.aus
UDP ports: local 1701, peer 3000
session limit: 0, session count: 1
tunnel profile: test_tunnel_primary, peer profile: default
session profile: default
hello timeout: 150, retry timeout: 80, idle timeout: 0
rx window size: 10, tx window size: 10, max retries: 5
use udp checksums: OFF
do pmtu discovery: OFF, mtu: 1460
trace flags: PROTOCOL FSM API AVPDATA FUNC XPRT DATA SYSTEM CLI
peer vendor name: Katalix Systems Ltd. Linux-2.6.32-358.2.1.el6.x86_64 (x86_64)
peer protocol version: 1.0, firmware 0
peer rx window size: 10
Transport status:-
ns/nr: 98/97, peer 98/96
cwnd: 10, ssthresh: 10, congpkt_acc: 9
Transport statistics:-
out-of-sequence control/data discards: 0/0
ACKs tx/txfail/rx: 0/0/96
retransmits: 0, duplicate pkt discards: 0, data pkt discards: 0
hellos tx/txfail/rx: 94/0/95
control rx packets: 193, rx bytes: 8506
control tx packets: 195, tx bytes: 8625
data rx packets: 0, rx bytes: 0, rx errors: 0
data tx packets: 6, tx bytes: 588, tx errors: 0
establish retries: 0

```

To view L2TPv3 tunnel config:

```
(Instant AP)# show l2tpv3 tunnel config
```

```

Tunnel profile test_tunnel_primary
l2tp host name: Instant-C4:42:98
local UDP port: 1701
peer IP address: 10.0.0.65
peer UDP port: 3000
hello timeout 150, retry timeout 80, idle timeout 0
rx window size 10, tx window size 10, max retries 5
use UDP checksums: OFF
do pmtu discovery: OFF, mtu: 1570
framing capability: SYNC ASYNC
bearer capability: DIGITAL ANALOG
use tiebreaker: OFF
peer profile: NOT SET
session profile: NOT SET
trace flags: PROTOCOL FSM API AVPDATA FUNC XPRT DATA SYSTEM CLI

Tunnel profile test_tunnel_backup
l2tp host name: arubal600pop658509.hsb-dev4.aus
local UDP port: 1701
peer IP address: 10.13.11.157
peer UDP port: 1701
hello timeout 60, retry timeout 1, idle timeout 0
rx window size 10, tx window size 10, max retries 5
use UDP checksums: OFF
do pmtu discovery: OFF, mtu: 1460
framing capability: SYNC ASYNC
bearer capability: DIGITAL ANALOG
use tiebreaker: OFF

```

```
peer profile: NOT SET
session profile: NOT SET
trace flags: PROTOCOL FSM API AVPDATA FUNC XPRT DATA SYSTEM CLI
```

To view L2TPv3 system statistics:

```
(Instant AP)# show l2tpv3 system statistics

L2TP counters:-
Total messages sent: 99, received: 194, retransmitted: 0
illegal: 0, unsupported: 0, ignored AVPs: 0, vendor AVPs: 0
Setup failures: tunnels: 0, sessions: 0
Resource failures: control frames: 0, peers: 0
tunnels: 0, sessions: 0
Limit exceeded errors: tunnels: 0, sessions: 0
Frame errors: short frames: 0, wrong version frames: 0
unexpected data frames: 0, bad frames: 0
Internal: authentication failures: 0, message encode failures: 0
no matching tunnel discards: 0, mismatched tunnel ids: 0
no matching session_discards: 0, mismatched session ids: 0
total control frame send failures: 0, event queue fulls: 0
Message counters:-
Message RX Good RX Bad TX
ILLEGAL 0 0 0
SCCRQ 0 0 1
SCCRP 1 0 0
SCCCN 0 0 1
STOPCCN 0 0 0
RESERVED1 0 0 0
HELLO 95 0 95
OCRQ 0 0 0
OCRP 0 0 0
OCCN 0 0 0
ICRQ 0 0 1
ICRP 1 0 0
ICCN 0 0 1
RESERVED2 0 0 0
CDN 0 0 0
WEN 0 0 0
SLI 0 0 0
```

Configuring Routing Profiles

OAW-IAPs can terminate a single VPN connection on an OmniAccess WLAN Switch. The routing profile defines the corporate subnets which need to be tunneled through IPSec. You can configure routing profiles to specify a policy based on routing into the VPN tunnel using the AOS-W Instant UI or CLI.

In the AOS-W Instant UI

To configure a routing profile:

1. Click **Routing** in the **Tunneling** window. The routing details are displayed.
2. Click **New**. The route parameters to configure are displayed.

Figure 57 Tunneling—Routing

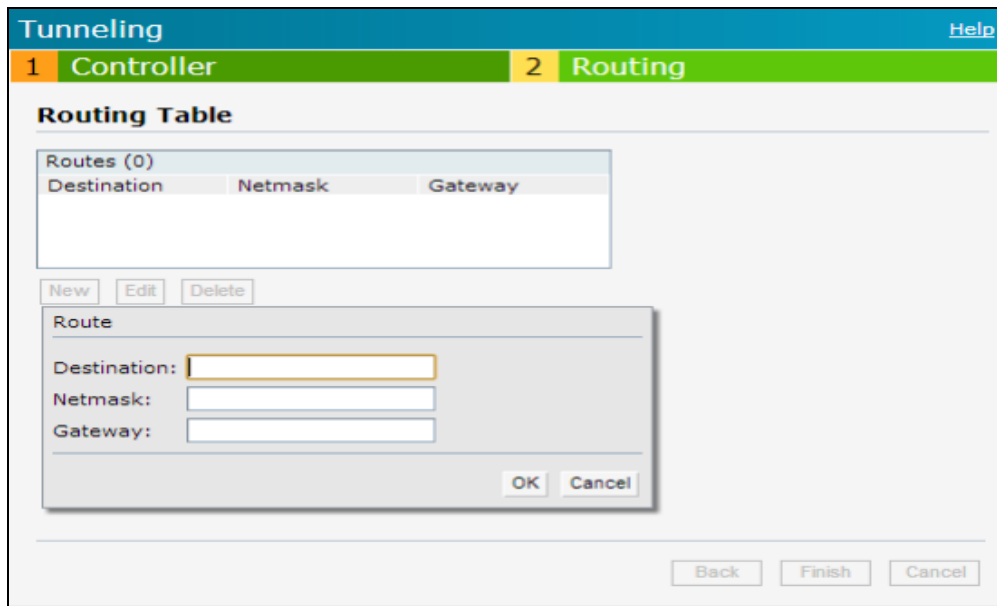

3. Update the following parameters:
 - **Destination**— Specify the destination network that is reachable through the VPN tunnel. This defines the IP or subnet that must reach through the IPsec tunnel. Traffic to the IP or subnet defined here will be forwarded through the IPsec tunnel.
 - **Netmask**— Specify the subnet mask to the destination defined for **Destination**.
 - **Gateway**— Specify the gateway to which traffic must be routed. This IP address must be the switch IP address on which the VPN connection is terminated. If you have a primary and backup host, configure two routes with the same destination and netmask, but ensure that the gateway is the primary switch IP for one route and the backup switch IP for the second route.
4. Repeat step 3 to create the required number of routing profiles.
5. Click **OK**.
6. Click **Finish**.

In the CLI

```
(Instant AP) (config)# routing-profile
(Instant AP) (Routing-profile)# route <destination> <mask> <gateway>
(Instant AP) (Routing-profile)# end
(Instant AP)# commit apply
```

This section provides the following information:

- [Understanding IAP-VPN Architecture on page 246](#)
- [Configuring OAW-IAP and Switch for IAP-VPN Operations on page 249](#)

Understanding IAP-VPN Architecture

The IAP-VPN architecture includes the following two components:

- OAW-IAPs at branch sites
- Switch at the datacenter

The master OAW-IAP at the branch acts as the VPN endpoint and the switch at the datacenter acts as the VPN concentrator. When an OAW-IAP is set up for VPN, it forms an IPsec tunnel to the switch to secure sensitive corporate data. IPsec authentication and authorization between the switch and the OAW-IAPs is based on the RAP whitelist configured on the switch.



Only the master AP in an OAW-IAP cluster forms the VPN tunnel.

From the switch perspective, the master OAW-IAPs that form the VPN tunnel are considered as VPN clients. The switch terminates VPN tunnels and routes or switches VPN traffic. The OAW-IAP cluster creates an IPsec or GRE VPN tunnel from the VC to a OmniAccess WLAN Switch in a branch office. The switch only acts as an IPsec or GRE VPN end-point and it does not configure the OAW-IAP.

IAP-VPN Scalability Limits

The switch scalability in IAP-VPN architecture depends on factors such as IPsec tunnel limit, Branch ID limit and datapath route table limit. The following table provides the IAP-VPN scalability information for various switch platforms:

Table 47: IAP-VPN Scalability

Platforms	Branches	Routes	L3 Mode Users	NAT Users	Total L2 Users
3200	1000	1000	N/A	N/A	64000
3400	2000	2000			64000
3600	8000	8000			64000
M3	8000	8000			64000
7210	8000	8000			64000
7220	16000	16000			128000
7240	32000	32000			128000

- **Branches**—The number of IAP-VPN branches that can be terminated on a given switch platform.
- **Routes**—The number of L3 routes supported on the switch.
- **L3 mode and NAT mode users**—The number of trusted users supported on the switch. There is no scale impact on the switch. They are limited only by the number of clients supported per OAW-IAP.
- **L2 mode users**—The number of L2 mode users are limited to 128000 for 7220/7240 and 64000 across all platforms.

IAP-VPN Forwarding Modes

The forwarding modes determine whether the DHCP server and default gateway for clients reside in the branch or at the datacenter. These modes do not determine the firewall processing or traffic forwarding behavior. The Virtual Controller enables different DHCP pools (various assignment modes) in addition to allocating IP subnets for each branch.

The Virtual Controller allows different modes of forwarding traffic from the clients on a VLAN based on the DHCP scope configured on the OAW-IAP.

For the IAP-VPN deployments, the following forwarding modes are supported:

- Local mode
- L2 Switching mode
- L3 routing mode

The DHCP scopes associated with these forwarding modes are described in the following sections.



Ensure that VLAN 1 is not configured for any of the DHCP scopes as it is reserved for a different purpose.

Local Mode

In this mode, the OAW-IAP cluster at that branch has a local subnet and the master OAW-IAP of the cluster acts as the DHCP server and gateway for clients. The local mode provides access to the corporate network using the inner IP of the IPsec tunnel. The network address for traffic destined to the corporate network is translated at the source with the inner IP of the IPsec tunnel and is forwarded through the IPsec tunnel. The traffic destined to the non-corporate network is translated using the IP address of the OAW-IAP and is forwarded through the uplink.



When the local mode is used for forwarding client traffic, hosts on the corporate network cannot establish connections to the clients on the OAW-IAP, because the source address of the clients is translated.

Local L2 Mode

In this mode, the OAW-IAP cluster at that branch has a local subnet and the master OAW-IAP of the cluster acts as the DHCP server. The default gateway is located outside the OAW-IAP and the network address for the client traffic is not translated at source. In the local L2 mode, access to the corporate network is supported only in a single OAW-IAP cluster. The traffic to the non-corporate network is locally bridged.

Local L3 Mode

In this mode, the network address for traffic destined to the corporate network is translated at the source with the inner IP of the IPsec tunnel and is forwarded through the IPsec tunnel. The traffic destined to the non-corporate network is routed.

Distributed L2 Mode

In this mode, the OAW-IAP assigns an IP address from the configured subnet and forwards traffic to both corporate and non-corporate destinations. Clients receive the corporate IP with Virtual Controller as the DHCP server. The default gateway for the client still resides in the datacenter and hence this mode is an L2 extension of corporate VLAN to remote site. Either the switch or an upstream router can be the gateway for the clients. Client traffic destined to datacenter resources is forwarded by the Master AP (through the IPsec tunnel) to the client's default gateway in the datacenter.

When an OAW-IAP registers with the switch, the switch automatically adds the VPN tunnel associated to this OAW-IAP into the VLAN multicast table. This allows the clients connecting to the L2 mode VLAN to be part of the same L2 broadcast domain on the switch.

Distributed L3 Mode

The distributed L3 mode contains all broadcast and multicast traffic to a branch. The distributed L3 mode reduces the cost and eliminates the complexity associated with the classic site-to-site VPN. However, this mode is very similar to a classic site-to-site IPsec VPN where two VPN endpoints connect individual networks together over a public network.

In distributed L3 mode, each branch location is assigned a dedicated subnet. The master AP in the branch manages the dedicated subnet and acts as the DHCP server and gateway for clients. Client traffic destined to datacenter resources is routed to the switch through the IPsec tunnel, which then routes the traffic to the appropriate corporate destinations.

When an OAW-IAP registers with the switch, the Switch adds a route to enable the routing of traffic from the corporate network to clients on this subnet in the branch.

Centralized L2 Mode

The centralized L2 mode extends the corporate VLAN or broadcast domain to remote branches. The DHCP server and the gateway for the clients reside in the datacenter. Either the switch or an upstream router can be the gateway for the clients. For DHCP services in centralized L2 mode, Alcatel-Lucent recommends using an external DHCP server and not the DHCP server on the switch. Client traffic destined to datacenter resources is forwarded by the master OAW-IAP (through the IPsec tunnel) to the client's default gateway in the datacenter.

Centralized L3 Mode

For centralized L3 clients, the virtual controller acts as a DHCP relay agent that forwards the DHCP traffic to the DHCP server located behind the switch in the corporate network and reachable through the IPsec tunnel. The centralized L3 VLAN IP is used as the source IP. The IP address is obtained from the DHCP server.

DHCP Scope and VPN Forwarding Modes Mapping

The following table provides a summary of the DHCP scope and VPN forwarding modes mapping:

Table 48: DHCP Scope and VPN Forwarding Modes Matrix

	Local	Local L2	Local L3	Centralized L2	Centralized L3	Distributed L2	Distributed L3
DHCP server	Virtual Controller	Virtual Controller	Virtual Controller	DHCP Server in the Datacenter	DHCP Server in the Datacenter and VC acts as a relay agent	Virtual Controller	Virtual Controller
Default Gateway for clients	Virtual Controller	Default Gateway in the local network	Virtual Controller	Controller or a router in the Datacenter	Virtual Controller	Controller or a router in the Datacenter	Virtual Controller
Corporate Traffic	SNAT is performed with inner IP of the IPsec tunnel	Not applicable	SNAT is performed with inner IP of the IPsec tunnel	L2 reachable	Routed	L2 reachable	Routed
Internet Traffic	SNAT is performed with local IP of the Virtual Controller	Locally bridged	Routed	SNAT is performed with local IP of the Virtual Controller	SNAT is performed with local IP of the Virtual Controller	SNAT is performed with local IP of the Virtual Controller	SNAT is performed with local IP of the Virtual Controller
Branch access from datacenter	No	No	No	Yes	Yes	Yes	Yes

Configuring OAW-IAP and Switch for IAP-VPN Operations

This section describes the configuration procedures to perform on the OAW-IAP and switch for generic use cases. For information on specific deployment scenarios, see [IAP-VPN Deployment Scenarios on page 396](#).

Configuring an OAW-IAP Network for IAP-VPN Operations



This section describes the configuration procedures to perform on the OAW-IAP for generic use cases. For information on specific deployment scenarios, see [IAP-VPN Deployment Scenarios on page 396](#).

An OAW-IAP network requires the following configuration for IAP-VPN operations.

1. [Defining the VPN host settings](#)
2. [Configuring Routing Profiles](#)
3. [Configuring DHCP Profiles](#)
4. [Configuring an SSID or Wired Port](#)

5. [Enabling Dynamic RADIUS Proxy](#)
6. [Configuring Enterprise Domains](#)

Defining the VPN host settings

The VPN endpoint on which a master OAW-IAP terminates its VPN tunnel is considered as the host. A master AP in an OAW-IAP network can be configured with a primary and backup host to provide VPN redundancy. You can define VPN host settings through **More>VPN>Controller** in the UI.

You can configure the following VPN profiles for the IAP-VPN operations. For more information, see [Configuring a Tunnel from an OAW-IAP to a Mobility Controller on page 233](#).

- IPsec
- Aruba GRE
- Manual GRE

Configuring Routing Profiles

The routing profile on the OAW-IAP determines whether the traffic destined to a subnet must be tunneled through IPsec or bridged locally. If the routing profile is empty, the client traffic will always be bridged locally. For example, if the routing profile is configured to tunnel 10.0.0.0 /8, traffic destined to 10.0.0.0 /8 will be forwarded through the IPsec tunnel and the traffic to all other destinations is bridged locally.

You can also configure a routing profile with 0.0.0.0 as gateway to allow both client and OAW-IAP traffic to be routed through a non-tunnel route. If the gateway is in the same subnet as uplink IP address, it is used as a static gateway entry. A static route can be added on all master and slave OAW-IAPs for these destinations. The VPN traffic from the local subnet of OAW-IAP or the virtual controller IP address in the local subnet is not routed to tunnel, but will be switched to the relevant VLAN. For example, when a 0.0.0.0/0.0.0.0 routing profile is defined, to bypass certain IPs, you can add a route to the IP by defining 0.0.0.0 as the destination, thereby forcing the traffic to be routed through the default gateway of the OAW-IAP.

You can configure routing profiles through **More>VPN>Controller** UI. For step-by-step procedural information on configuring routing profile, see [Configuring Routing Profiles on page 244](#).



The OAW-IAP network has only one active tunnel even when fast failover enabled. At any given time, traffic can be tunneled only to one VPN host.

Configuring DHCP Profiles

You can create DHCP profiles to determine the IAP-VPN mode of operation. An OAW-IAP network can have multiple DHCP profiles configured for different modes of IAP-VPN. You can configure up to eight DHCP profiles. For more information on the IAP-VPN modes of operation, see [IAP-VPN Forwarding Modes on page 247](#).

You can create any of the following types of DHCP profiles for the IAP-VPN operations:

- Local
- Local, L2
- Local, L3
- Distributed, L2
- Distributed, L3
- Centralized

For more information on configuring DHCP profiles, see [Configuring DHCP Scopes on page 215](#).



A centralized L2 or distributed L2 VLAN or subnet cannot be used to serve APs in a hierarchical mode of

deployment. Ensure that the physical IP of the APs connecting to the master AP in hierarchical mode of deployment is not on a VLAN or subnet that is in centralized or distributed L2 mode of operation. For information on hierarchical mode of deployment, see [Understanding Hierarchical Deployment on page 122](#).

Configuring an SSID or Wired Port

For a client to connect to the IAP-VPN network, an SSID or wired port profile on an OAW-IAP must be configured with appropriate IAP-VPN mode of operation. The VLAN configuration in an SSID or wired port profile determines whether an SSID or wired port is configured for the IAP-VPN operations.

To configure an SSID or wired port for a specific IAP-VPN mode, the VLAN ID defined in the SSID or wired port profile must match the VLAN ID defined in the DHCP profile configuration. If the VLAN assignment for an SSID or wired port profile is set to Virtual controller assigned, custom, or a static VLAN ID that does not match the VLAN ID configured in the DHCP profiles, the IAP-VPN operations are affected. For example, if a local DHCP profile is configured with a VLAN ID of 200, the VLAN configuration on the SSID must be set to a static VLAN ID 200.



Ensure that the VLAN assignment for an SSID or wired port profile is not set to default as the VPN tunnel is not supported on the default VLAN.

For information on how to configure an SSID or wired port profile, see [Wireless Network Profiles on page 90](#) and [Configuring a Wired Profile on page 115](#) respectively.

Enabling Dynamic RADIUS Proxy

The RADIUS server can be deployed at different locations and VLANs. In most cases, a centralized RADIUS or local server is used to authenticate users. However, some user networks can use a local RADIUS server for employee authentication and a centralized RADIUS based captive portal server for guest authentication. To ensure that the RADIUS traffic is routed to the required RADIUS server, the dynamic RADIUS proxy feature must be enabled. When enabled, dynamic RADIUS proxy ensures that all the RADIUS traffic is sourced from the Virtual Controller IP or inner IP of the OAW-IAP IPsec tunnel depending on the RADIUS server IP and routing profile.



Ensure that a static Virtual Controller IP is configured before enabling dynamic RADIUS proxy, in order to tunnel the RADIUS traffic to the central RADIUS server in the datacenter.

For information on enabling dynamic RADIUS proxy, see [Configuring Dynamic RADIUS Proxy Parameters on page 170](#).

Configuring Enterprise Domains

By default, all the DNS requests from a client are forwarded to the clients DNS server. In a typical OAW-IAP deployment without VPN configuration, client DNS requests are resolved by the DNS server of clients. For the IAP-VPN scenario, the enterprise domain settings on the OAW-IAP are used for determining how client DNS requests are routed. For information on how to configure enterprise domains, see [Configuring Enterprise Domains on page 201](#).

Configuring a Switch for IAP-VPN Operations

Alcatel-Lucent switches provide an ability to terminate the IPsec and GRE VPN tunnels from the OAW-IAP and provide corporate connectivity to the branch network. For IAP-VPN operations, ensure that the following configuration and verification procedures are completed on the switch:

- [OSPF Configuration](#)
- [VPN Configuration](#)

- [Branch-ID Allocation](#)
- [Branch Status Verification](#)



This section describes the configuration procedures to perform on the switch for generic use cases. For information on specific deployment scenarios, see [IAP-VPN Deployment Scenarios on page 396](#).



AOS-W Instant 6.3 or later is the recommended version to run on the switches for the IAP-VPN configuration. The IAP-VPN configuration is not supported on OAW-4306 Series switches.

OSPF Configuration

Open Shortest Path First (OSPF) is a dynamic Interior Gateway routing Protocol (IGP) based on IETF RFC 2328. The premise of OSPF is that the shortest or fastest routing path is used. The implementation of OSPFv2 allows switches to deploy effectively in a Layer 3 topology. The switches can act as the default gateway for all clients and forward user packets to the upstream router.

Each IAP-VPN can be defined a separate subnet derived from the corporate intranet pool to allow IAP-VPN devices to work independently. For sample topology and configuration, see *AOS-W Instant User Guide*.

To redistribute IAP-VPN routes into the OSPF process, use the following command :

```
(host) (config) # router ospf redistribute rapng-vpn
```

To verify if the redistribution of the IAP-VPN is enabled, use following command:

```
(host) #show ip ospf redistribute
Redistribute RAPNG
```

To configure aggregate route for IAP-VPN routes, use the following command:

```
(host) (config) # router ospf aggregate-route rapng-vpn
```

To view the aggregated routes for IAP-VPN routes, use the following command:

```
(host) #show ip ospf rapng-vpn aggregate-routes
RAPNG VPN aggregate routes
-----
```

```
Prefix Mask Contributing routes Cost
-----
201.201.200.0 255.255.252.0 5 268779624
100.100.2.0 255.255.255.0 1 10
```

To verify the details of configured aggregated route, use the following command:

```
(host) # show ip ospf rapng-vpn aggregated-routes <net> <mask>
(host) #show ip ospf rapng-vpn aggregate-routes 100.100.2.0 255.255.255.0
Contributing routes of RAPNG VPN aggregate route
-----
```

```
Prefix Mask Next-Hop Cost
-----
100.100.2.64 255.255.255.224 5.5.0.10 10
```

To view all the redistributed routes:

```
(host) #show ip ospf database
OSPF Database Table
-----
```

Area ID	LSA Type	Link ID	Adv Router	Age	Seq#	Checksum
0.0.0.15	ROUTER	9.9.9.9	9.9.9.9	159	0x80000016	0xee92
0.0.0.15	ROUTER	10.15.148.12	10.15.148.12	166	0x80000016	0x4c0d
0.0.0.15	NETWORK	10.15.148.12	10.15.148.12	167	0x80000001	0x9674
0.0.0.15	NSSA	12.12.2.0	9.9.9.9	29	0x80000003	0x7b54
0.0.0.15	NSSA	12.12.12.0	9.9.9.9	164	0x80000008	0x63a
0.0.0.15	NSSA	12.12.12.32	9.9.9.9	164	0x80000008	0x7b8

0.0.0.15	NSSA	50.40.40.0	9.9.9.9	164	0x80000007	0x8ed4
0.0.0.15	NSSA	51.41.41.128	9.9.9.9	164	0x80000007	0x68f6
0.0.0.15	NSSA	53.43.43.32	9.9.9.9	164	0x80000007	0x2633
0.0.0.15	NSSA	54.44.44.16	9.9.9.9	164	0x80000007	0x353
N/A	AS_EXTERNAL	12.12.2.0	9.9.9.9	29	0x80000003	0x8c06
N/A	AS_EXTERNAL	12.12.12.0	9.9.9.9	169	0x80000001	0x25e4
N/A	AS_EXTERNAL	12.12.12.32	9.9.9.9	169	0x80000001	0x2663
N/A	AS_EXTERNAL	50.40.40.0	9.9.9.9	169	0x80000001	0xab80
N/A	AS_EXTERNAL	51.41.41.128	9.9.9.9	169	0x80000001	0x85a2
N/A	AS_EXTERNAL	53.43.43.32	9.9.9.9	169	0x80000001	0x43de
N/A	AS_EXTERNAL	54.44.44.16	9.9.9.9	169	0x80000001	0x20fe

To verify if the redistributed routes are installed or not:

```
(host) #show ip route
Codes: C - connected, O - OSPF, R - RIP, S - static
M - mgmt, U - route usable, * - candidate default, V - RAPNG VPN
Gateway of last resort is Imported from DHCP to network 0.0.0.0 at cost 10
Gateway of last resort is Imported from CELL to network 0.0.0.0 at cost 10
Gateway of last resort is Imported from PPPOE to network 0.0.0.0 at cost 10
Gateway of last resort is 10.15.148.254 to network 0.0.0.0 at cost 1
S* 0.0.0.0/0 [1/0] via 10.15.148.254*
V 12.12.2.0/24 [10/0] ipsec map
V 12.12.12.0/25 [10/0] ipsec map
V 12.12.12.32/27 [10/0] ipsec map
V 50.40.40.0/24 [10/0] ipsec map
V 51.41.41.128/25 [10/0] ipsec map
V 53.43.43.32/27 [10/0] ipsec map
V 54.44.44.16/28 [10/0] ipsec map
C 9.9.9.0/24 is directly connected, VLAN9
C 10.15.148.0/24 is directly connected, VLAN1
C 43.43.43.0/24 is directly connected, VLAN132
C 42.42.42.0/24 is directly connected, VLAN123
C 44.44.44.0/24 is directly connected, VLAN125
C 182.82.82.12/32 is an ipsec map 10.15.149.69-182.82.82.12
C 182.82.82.14/32 is an ipsec map 10.17.87.126-182.82.82.14
```

VPN Configuration

The following VPN configuration steps on the switch enable the OAW-IAPs to terminate their VPN connection on the switch:

Whitelist Database Configuration

The whitelist database is a list of the MAC addresses of the OAW-IAPs that are allowed to establish VPN connections with the switch. This list can be either stored in the switch database or on an external server.

You can use the following CLI command to configure the whitelist database entry if the switch is acting as the whitelist database:

```
(host)# whitelist-db rap add mac-address 00:11:22:33:44:55 ap-group test
```

The **ap-group** parameter is not used for any configuration, but needs to be configured. The parameter can be any valid string.

If an external server is used as the location for the whitelist database, add the MAC addresses of the valid OAW-IAPs in the external database or external directory server and then configure a RADIUS server to authenticate the OAW-IAPs using the entries in the external database or external directory server.

If you are using the Windows 2003 server, perform the following steps to configure the external whitelist database on it. There are equivalent steps available for the Windows Server 2008 and other RADIUS servers.

1. Add the MAC addresses for all the OAW-IAPs in the Active Directory of the RADIUS server:

- a. Open the **Active Directory and Computers** window, add a new user and specify the MAC address (without the colon delimiter) of the OAW-IAP for the user name and password.
 - b. Right-click the user that you have just created and click **Properties**.
 - c. On the **Dial-in** tab, select **Allow access** in the **Remote Access Permission** section and click **OK**.
 - d. Repeat Step a through Step b for all OAW-IAPs.
2. Define the remote access policy in the Internet Authentication Service:
 - a. In the **Internet Authentication Service** window, select **Remote Access Policies**.
 - b. Launch the wizard to configure a new remote access policy.
 - c. Define filters and select **grant remote access permission** in the **Permissions** window.
 - d. Right-click the policy that you have just created and select **Properties**.
 - e. In the **Settings** tab, select the policy condition, and **Edit Profile...**
 - f. In the **Advanced** tab, select **Vendor Specific**, and click **Add** to add new vendor specific attributes.
 - g. Add new vendor specific attributes and click **OK**.
 - h. In the **IP** tab, provide the IP address of the OAW-IAP and click **OK**.

VPN Local Pool Configuration

The VPN local pool is used to assign an IP Address to the OAW-IAP after successful XAUTH VPN.

```
(host) # ip local pool "rapngpool" <startip> <endip>
```

Role Assignment for the Authenticated OAW-IAPs

Define a role that includes a src-nat rule to allow connections to the RADIUS server and for the Dynamic Radius Proxy in the OAW-IAP to work. This role is assigned to OAW-IAPs after successful authentication.

```
(host) (config) #ip access-list session iaprole
(host) (config-sess-iaprole)#any host <radius-server-ip> any src-nat
(host) (config-sess-iaprole)#any any any permit
(host) (config-sess-iaprole)#!
(host) (config) #user-role iaprole
(host) (config-role) #session-acl iaprole
```

VPN Profile Configuration

The VPN profile configuration defines the server used to authenticate the OAW-IAP (internal or an external server) and the role assigned to the OAW-IAP after successful authentication.

```
(host) (config) #aaa authentication vpn default-iap
(host) (VPN Authentication Profile "default-iap") #server-group default
(host) (VPN Authentication Profile "default-iap") #default-role iaprole
```

Branch-ID Allocation

For branches deployed in distributed L3 and distributed L2 mode, the master AP in the branch and the switch should agree upon a subnet/IP addresses to be used for DHCP services in the branch. The process or protocol used by the master AP and the switch to determine the subnet/IP addresses used in a branch is called BID allocation. The BID allocation process is not essential for branches deployed in local or centralized L2 mode. The following are some of the key functions of the BID allocation process:

- Determines the IP addresses used in a branch for distributed L2 mode
- Determines the subnet used in a branch for distributed L3 mode
- Avoids IP address or subnet overlap (that is, avoids IP conflict)
- Ensures that a branch is allocated the same subnet or range of IP addresses irrespective of which AP in the branch becomes the master in the OAW-IAP cluster

Branch Status Verification

To view the details of the branch information connected to the switch, execute the **show iap table** command.

Example

This example shows the details of the branches connected to the switch:

```
(host) #show iap table long

IAP Branch Table
-----
Name VC MAC Address Status Inner IP Assigned Subnet Assigned Vlan
-----
Tokyo-CB:D3:16 6c:f3:7f:cc:42:f8 DOWN 0.0.0.0
Paris-CB:D3:16 6c:f3:7f:cc:3d:04 UP 10.15.207.140 10.15.206.99/29 2
LA 6c:f3:7f:cc:42:25 UP 10.15.207.111 10.15.206.24/29 2
Munich d8:c7:c8:cb:d3:16 DOWN 0.0.0.0
London-c0:e1 6c:f3:7f:c0:e1:b1 UP 10.15.207.120 10.15.206.64/29 2
Instant-CB:D3 6c:f3:7f:cc:42:1e DOWN 0.0.0.0
Delhi 6c:f3:7f:cc:42:ca DOWN 0.0.0.0
Singapore 6c:f3:7f:cc:42:cb UP 10.15.207.122 10.15.206.120/29 2

Key Bid(Subnet Name)
-----
b3c65c...
b3c65c...
b3c65c... 2(10.15.205.0-10.15.205.250,5),1(10.15.206.1-10.15.206.252,5)
a2a65c... 0
b3c65c... 7(10.15.205.0-10.15.205.250,5),8(10.15.206.1-10.15.206.252,5)
b3c65c...
b3c65c... 1(10.15.205.0-10.15.205.250,5),2(10.15.206.1-10.15.206.252,5)
b3c65c... 14(10.15.205.0-10.15.205.250,5),15(10.15.206.1-10.15.206.252,5)
```

The output of this command provides the following information:

Table 49: Branch Details

Parameter	Description
Name	Displays the name of the branch.
VC MAC Address	Displays the MAC address of the Virtual Controller of the branch.
Status	Displays the current status of the branch (UP/DOWN).
Inner IP	Displays the internal VPN IP of the branch.
Assigned Subnet	Displays the subnet mask assigned to the branch.

Parameter	Description
Assigned Vlan	Displays the VLAN ID assigned to the branch.
Key	Displays the key for the branch, which is unique to each branch.
Bid (Subnet Name)	<p>Displays the Branch ID (BID) of the subnet.</p> <ul style="list-style-type: none"> In the example above, the switch displays bid-per-subnet-per-branch i.e., for "LA" branch, BID "2" for the ip-range "10.15.205.0-10.15.205.250" with client count per branch "5"). If a branch has multiple subnets, it can have multiple BIDs. If a branch is in UP state and does not have a Bid(Subnet Name), it means that the OAW-IAP is connected to a switch, which did not assign any BID for any subnet. In the above example, "Paris-CB:D3:16" branch is UP and does not have a Bid (Subnet Name). This means that either the OAW-IAP is connected to a backup switch or it is connected to a primary switch without any distributed L2 or L3 subnets.



The **show iap table** command output does not display the **Key** and **Bid(Subnet Name)** details.

This chapter provides the following information:

- [ARM Overview on page 257](#)
- [Configuring ARM Features on an OAW-IAP on page 258](#)
- [Configuring Radio Settings on page 264](#)

ARM Overview

Adaptive Radio Management (ARM) is a radio frequency management technology that optimizes WLAN performance even in the networks with highest traffic by dynamically and intelligently choosing the best 802.11 channel and transmitting power for each OAW-IAP in its current RF environment. ARM works with all standard clients, across all operating systems, while remaining in compliance with the IEEE 802.11 standards. It does not require any proprietary client software to achieve its performance goals. ARM ensures low-latency roaming, consistently high performance, and maximum client compatibility in a multi-channel environment. By ensuring the fair distribution of available Wi-Fi bandwidth to mobile devices, ARM ensures that data, voice, and video applications have sufficient network resources at all times. ARM allows mixed 802.11 a, b, g, n, and ac client types to inter operate at the highest performance levels.

Channel or Power Assignment

The channel or power assignment feature automatically assigns channel and power settings for all the OAW-IAPs in the network according to changes in the RF environment. This feature automates many setup tasks during network installation and the ongoing operations when RF conditions change.

Voice Aware Scanning

The Voice Aware scanning feature prevents an OAW-IAP supporting an active voice call from scanning for other channels in the RF spectrum and allows an OAW-IAP to resume scanning when there are no active voice calls. This significantly improves the voice quality when a call is in progress and simultaneously delivers the automated RF management functions. By default, this feature is enabled.

Load Aware Scanning

The Load Aware Scanning feature dynamically adjusts scanning behavior to maintain uninterrupted data transfer on resource intensive systems when the network traffic exceeds a predefined threshold. The OAW-IAPs resume complete monitoring scans when the traffic drops to the normal levels. By default, this feature is enabled.

Monitoring the Network with ARM

When ARM is enabled, an OAW-IAP dynamically scans all 802.11 channels within its 802.11 regulatory domain at regular intervals and sends reports to a Virtual Controller on network (WLAN) coverage, interference, and intrusion detection.

ARM Metrics

ARM computes coverage and interference metrics for each valid channel and chooses the best performing channel and transmit power settings for each OAW-IAP RF environment. Each OAW-IAP gathers other metrics on its ARM-assigned channel to provide a snapshot of the current RF health state.

Configuring ARM Features on an OAW-IAP

This section describes the following procedures for configuring ARM features:

- [Band Steering on page 258](#)
- [Airtime Fairness Mode on page 259](#)
- [Client Match on page 259](#)
- [Access Point Control on page 261](#)

Band Steering

The band steering feature assigns the dual-band capable clients to the 5 GHz band on dual-band OAW-IAPs. This feature reduces co-channel interference and increases available bandwidth for dual-band clients, because there are more channels on the 5 GHz band than on the 2.4 GHz band. You can configure band steering parameters through the AOS-W Instant UI or CLI.

In the AOS-W Instant UI

To configure band steering:

1. In the **RF > ARM > Show advanced options** tab view, configure the following parameters:

Table 50: Band Steering Mode - Configuration Parameters

Parameter	Description
Prefer 5 GHz	Select this option to use band steering in the 5 GHz mode. On selecting this, the OAW-IAP steers the client to the 5 GHz band (if the client is 5 GHz capable), but allows the client connection on the 2.4 GHz band if the client persistently attempts for 2.4 GHz association.
Force 5 GHz	Select this option to enforce 5 GHz band steering mode on the OAW-IAPs.
Balance Bands	Select this option to allow the OAW-IAP to balance the clients across the two radios to best utilize the available 2.4 GHz bandwidth. This feature takes into account the fact that the 5 GHz band has more channels than the 2.4 GHz band, and that the 5 GHz channels operate in 40MHz, while the 2.5 GHz band operates in 20MHz.
Disabled	Select this option if you want to allow the clients to select the band to use.

2. Click **OK**.

In the CLI

To configure band steering:

```
(Instant AP) (config)# arm
(Instant AP) (ARM)# band-steering-mode {<Prefer 5 GHz>| <Force 5 GHz>|<Balance
Bands>|<Disabled>}
(Instant AP) (ARM)# end
(Instant AP)# commit apply
```

Airtime Fairness Mode

The airtime fairness feature provides equal access to all clients on the wireless medium, regardless of client type, capability, or operating system, thus delivering uniform performance to all clients. This feature prevents the clients from monopolizing resources. You can configure airtime fairness mode parameters through the AOS-W Instant UI or CLI.

In the AOS-W Instant UI

1. For **Airtime fairness mode** configuration, specify any of the following values under the **RF > ARM > Show advanced options** tab:

Table 51: Airtime Fairness Mode - Configuration Parameters

Parameter	Description
Default Access	Select this option to provide access based on client requests. When Air Time Fairness is set to default access, per user and per SSID bandwidth limits are not enforced.
Fair Access	Select this option to allocate Airtime evenly across all the clients.
Preferred Access	Select this option to set a preference where 11n clients are assigned more airtime than 11a/11g. The 11a/11g clients get more airtime than 11b. The ratio is 16:4:1.

2. Click **OK**.

In the CLI

```
(Instant AP) (config) # arm
(Instant AP) (ARM) # air-time-fairness-mode {<Default Access>| <Fair Access> | <Preferred
Access>
(Instant AP) (ARM) # end
(Instant AP) # commit apply
```

Client Match

The ARM client match feature continually monitors a client's RF neighborhood to provide ongoing client band steering and load balancing, and enhanced AP reassignment for roaming mobile clients. This feature supersedes the legacy band steering and spectrum load balancing features, which unlike client match, do not trigger OAW-IAP changes for clients already associated to an OAW-IAP. In addition to this, the Client Match feature provides the Smartphone Handoff Assist function which helps smartphones to switch between 3G and 4G networks when the Wi-Fi connectivity is poor. The OAW-IAP monitors the Received Signal Strength Indicator (RSSI) of the smartphone and checks if it remains under the threshold connectivity strength for a certain time and deauthenticates the client.

Legacy 802.11 a/b/g access points do not support the client match feature. When client match is enabled on 802.11n capable access points, the client match feature overrides any settings configured for the legacy band steering, station hand off assist or load balancing features. 802.11ac-capable access points do not support the legacy band steering, station hand off or load balancing settings, so these access points must be managed using client match.



When the client match feature is enabled on an OAW-IAP, the OAW-IAP measures the RF health of its associated clients. In the current release, the client match feature is supported only within an OAW-IAP cluster. If any of the following trigger conditions is met, clients are moved from one AP to another for better performance and client experience:

- **Dynamic Load Balancing**—Client match balances clients across OAW-IAPs on different channels, based on the client load on the OAW-IAPs and the SNR levels the client detects from an underutilized OAW-IAP. If an OAW-IAP radio can support additional clients, the OAW-IAP will participate in client match load balancing and clients can be directed to that OAW-IAP radio, subject to the predefined SNR thresholds. For better load balancing, clients are steered from busy channels to idle channels.
- **Sticky Clients**—The client match feature also helps mobile clients that tend to stay associated to an OAW-IAP despite low signal levels. OAW-IAPs using client match continually monitor the client's RSSI as it roams between OAW-IAPs, and move the client to an OAW-IAP when a better radio match can be found. This prevents mobile clients from remaining associated to an APs with less than ideal RSSI, which can cause poor connectivity and reduce performance for other clients associated with that OAW-IAP.
- **Band Steering**—OAW-IAPs using the client match feature monitor the RSSI for clients that advertise a dual-band capability. If a client is currently associated to a 2.4 GHz radio and the AP detects that the client has a good RSSI from the 5 GHz radio, the OAW-IAP steers the client to the 5 GHz radio, as long as the 5 GHz RSSI is not significantly worse than the 2.4 GHz RSSI, and the OAW-IAP retains a suitable distribution of clients on each of its radios.
- **Channel Utilization**—Based on the percentage of channel utilization, clients are steered from a busy channel to an idle channel.
- **Client Capability Match**—Based on the client capability match, clients are steered to appropriate channel, for example, HT20, HT40, or VHT80.



In the Instant 6.3.1.1-4.0 release, spectrum load balancing is integrated with the client match feature. Client match allows the APs in a cluster to be divided into several logical AP RF neighborhood called domains, which share the same clients. The Virtual Controller determines the distribution of clients and balances client load across channels, regardless of whether the AP is responding to the probe requests of wireless clients.

You can configure client match parameters in AOS-W Instant UI or CLI. When client match is enabled, the dashboard in the main window displays the **Client Match** link on selecting an AP in the **Access Points** tab or a client in the **Clients** tab. Clicking this link provides a graphical representation of radio map view of an AP and the client distribution on an AP radio. For more information, see [Client Match on page 64](#).

In the AOS-W Instant UI

1. For client match configuration, specify the following parameters the **RF > ARM > Show advanced options** tab:

Table 52: Client Match Configuration Parameters

Parameter	Description
Client match	Select Enabled to enable the Client match feature on APs. When enabled, client count will be balanced among all the channels in the same band. For more information, see ARM Overview on page 257 . By default, the client match feature is disabled. NOTE: When client match is enabled, ensure that Scanning is enabled.
CM calculating interval	Specify a value for the calculating interval of Client match. The value specified for CM calculating interval determines the interval at which client match is calculated. The interval is specified in seconds and the default value is 30 seconds. You can specify a value within the range of 10-600.
CM neighbor matching %	Specify a value for CM neighbor matching % . This number takes into account the least similarity percentage to be considered as in the same virtual RF neighborhood of client match. You can specify a percentage value within the range of 20-100. The default value is 75%.
CM threshold	Specify a value for CM threshold . This number takes acceptance client count difference among all the channels of Client match into account. When the client load on an AP reaches or exceeds the threshold in comparison, client match is enabled on that AP. You can specify a value within range of 1-255. The default value is 2.
SLB mode	Select a mode from the SLB mode drop-down list. The SLB mode determines the balancing strategy for client match. The following options are available: <ul style="list-style-type: none">• Channel• Radio• Channel + Radio

2. Click **OK**.

In the CLI

```
(Instant AP) (config)# arm
(Instant AP) (ARM) # client-match calc-interval <seconds>
(Instant AP) (ARM) # client-match calc-threshold <threshold>
(Instant AP) (ARM) # client-match nb-matching <percentage>
(Instant AP) (ARM) # client-match slb-mode 1
(Instant AP) (ARM) # end
(Instant AP) # commit apply
```

Access Point Control

You can configure access point control parameters through the AOS-W Instant UI or CLI.

In the AOS-W Instant UI

1. For **Access Point Control**, specify the following parameters in the **RF > ARM > Show advanced options** tab:

Table 53: Access Point Control - Configuration Parameters

Parameter	Description
Customize Valid Channels	Select this checkbox to customize valid channels for 2,4 GHz and 5 GHz. By default, the AP uses valid channels as defined by the Country Code (regulatory domain). On selecting the Customize Valid Channels checkbox, a list of valid channels for both 2.4.GHz and 5 GHz are displayed. The valid channel customization feature is disabled by default..
Minimum Transmit Power	Specify the minimum transmission power. The value specified for Minimum Transmit Power indicates the minimum Effective Isotropic Radiated Power (EIRP) from 3 to 33 dBm in 3 dBm increments. If the minimum transmission EIRP setting configured on an AP is not supported by the AP model, this value is reduced to the highest supported power setting. The default value is for minimum transmit power is 18 dBm.
Maximum Transmit Power	Specify the maximum transmission power. The value specified for Maximum Transmit Power indicates the maximum Effective Isotropic Radiated Power (EIRP) from 3 to 33 dBm in 3 dBm increments. If the maximum transmission EIRP configured on an AP is not supported by the AP model, the value is reduced to the highest supported power setting. The default value for maximum transmit power is 127 dBm.
Client aware	When Enabled , ARM does not change channels for the APs with active clients, except for high priority events such as radar or excessive noise. This feature must be enabled in most deployments for a stable WLAN. If the Client Aware mode is Disabled , the OAW-IAP may change to a more optimal channel, which change may disrupt current client traffic for a while. The Client aware option is Enabled by default. NOTE: When Client aware is disabled, channels can be changed even when the clients are active on a BSSID.
Scanning	Select Enabled so that the OAW-IAP dynamically scans all 802.11 channels within its 802.11 regulatory domain at regular intervals and reports to the OAW-IAP. This scanning report includes WLAN coverage, interference, and intrusion detection data. NOTE: For client match configuration, ensure that scanning is enabled.
Wide Channel Bands	Select a band to allow the APs to be placed in 40Mhz (wide band) channels. The Wide channel band allows administrators to configure 40 MHz channels in the 2.4 GHz and 5.0 GHz bands. 40 MHz channels are two 20 MHz adjacent channels that are bonded together. 40 MHz channel effectively doubles the frequency bandwidth available for data transmission.
80 MHz Support	Enables or disables the use of 80 MHz channels on APs. This feature allows ARM to assign 80 MHz channels on APs with 5GHz radios, which support a very high throughput. This setting is enabled by default. NOTE: Only the APs that support 802.11 ac can be configured with 80 MHz channels.

2. Reboot the OAW-IAP.

3. Click **OK**.

In the CLI

To configure access point control parameters:

```
(Instant AP) (config) # arm
(Instant AP) (ARM) # a-channels <5GHz-channels>
(Instant AP) (ARM) # min-tx-power <power>
(Instant AP) (ARM) # max-tx-power <power>
(Instant AP) (ARM) # client-aware
(Instant AP) (ARM) # wide-bands {<5GHz>|<2GHz>|<All>|<None>}
(Instant AP) (ARM) # scanning
(Instant AP) (ARM) # 80mhz-support
(Instant AP) (ARM) # end
(Instant AP) # commit apply
```

Verifying ARM Configuration

To view ARM configuration:

```
(Instant AP) # show arm config

Minimum Transmit Power :18
Maximum Transmit Power :127
Band Steering Mode :prefer-5ghz
Client Aware :enable
Scanning :enable
Wide Channel Bands :5ghz
80Mhz Support :enable
Air Time Fairness Mode :fair-access
Client Match :disable
CM NB Matching Percent :75
CM Calculating Interval :30
CM SLB Threshold :2
CM SLB Balancing Mode :channel based
CM max client match req :5
CM max adoption :5
Custom Channels :No
2.4 GHz Channels
-----
Channel Status
-----
1 enable
2 disable
3 disable
4 disable
5 disable
6 enable
7 disable
8 disable
9 disable
10 disable
11 enable
12 disable
13 disable
1+ enable
2+ disable
3+ disable
4+ disable
5+ disable
6+ disable
7+ enable
```

5.0 GHz Channels

Channel Status

```
-----  
36 enable  
40 enable  
44 enable  
48 enable  
52 enable  
56 enable  
60 enable  
64 enable  
149 enable  
153 enable  
157 enable  
161 enable  
165 enable  
36+ enable  
44+ enable  
52+ disable  
60+ disable  
149+ enable  
157+ enable  
36E enable  
52E enable  
149E enable
```

Configuring Radio Settings

You can configure 2.4 GHz and 5 GHz radio settings for an OAW-IAP either using the AOS-W Instant UI or CLI.

In the AOS-W Instant UI

To configure radio settings:

1. Click the **RF** link at the top right corner of the AOS-W Instant main window.
2. Click **Show advanced options**. The advanced options are displayed.
3. Click the **Radio** tab.
4. Under the channel 2.4.GHz or 5GHz, or both, configure the following parameters.

Table 54: Radio Configuration Parameters

Parameter	Description
Legacy only	Select Enabled to run the radio in non-802.11n mode. This option is set to Disabled by default.
802.11d / 802.11h	Select Enabled to allow the radio to advertise its 802.11d (Country Information) and 802.11h (Transmit Power Control) capabilities. This option is set to Disabled by default.
Beacon interval	Enter the Beacon period for the OAW-IAP in milliseconds. This indicates how often the 802.11 beacon management frames are transmitted by the access point. You can specify a value within the range of 60-500. The default value is 100 milliseconds.

Parameter	Description
Interference immunity level	<p>Select to increase the immunity level to improve performance in high-interference environments.</p> <p>The default immunity level is 2.</p> <ul style="list-style-type: none"> • Level 0— no ANI adaptation. • Level 1— Noise immunity only. This level enables power-based packet detection by controlling the amount of power increase that makes a radio aware that it has received a packet. • Level 2— Noise and spur immunity. This level also controls the detection of OFDM packets, and is the default setting for the Noise Immunity feature. • Level 3— Level 2 settings and weak OFDM immunity. This level minimizes false detects on the radio due to interference, but may also reduce radio sensitivity. This level is recommended for environments with a high-level of interference related to 2.4 GHz appliances such as cordless phones. • Level 4— Level 3 settings, and FIR immunity. At this level, the AP adjusts its sensitivity to in-band power, which can improve performance in environments with high and constant levels of noise interference. • Level 5— The AP completely disables PHY error reporting, improving performance by eliminating the time the OAW-IAP would spend on PHY processing. <p>NOTE: Increasing the immunity level makes the AP to lose a small amount of range.</p>
Channel switch announcement count.	Specify the count to indicate the number of channel switching announcements that must be sent before switching to a new channel. This allows associated clients to recover gracefully from a channel change.
Background spectrum monitoring	Select Enabled to allow the APs in access mode to continue with normal access service to clients, while performing additional function of monitoring RF interference (from both neighboring APs and non Wi-Fi sources such as, microwaves and cordless phones) on the channel they are currently serving clients.
Customize ARM power range	Select the checkbox and choose a minimum (Min Power) and maximum (Max Power) power range value for the 2.4 GHz and 5GHz band frequencies. The default value is 3 dBm. Unlike the configuration in the ARM profile, the transmit power of all radios in the Radio profile do not share the same configuration.
Very high throughput	<p>Ensure that this checkbox is selected to enable very high throughput (VHT) on 802.11ac devices with 5GHz radio. If VHT is enabled for the 5 GHz radio profile on an OAW-IAP, it is automatically enabled for all SSIDs configured on an IAP. By default, VHT is enabled on all SSIDs.</p> <p>If you want the 802.11ac OAW-IAPs to function as 802.11n OAW-IAPs, clear the checkbox to disable VHT on these devices.</p>

5. Click **OK**.

In the CLI

To configure 2.4 GHz radio settings:

```
(Instant AP) (config)# rf dot11g-radio-profile
```

```

(Instant AP) (RF dot11 g Radio Profile)# beacon-interval <milliseconds>
(Instant AP) (RF dot11 g Radio Profile)# legacy-mode
(Instant AP) (RF dot11 g Radio Profile)# spectrum-monitor
(Instant AP) (RF dot11 g Radio Profile)# dot11h
(Instant AP) (RF dot11 g Radio Profile)# interference-immunity <level>
(Instant AP) (RF dot11 g Radio Profile)# csa-count <count>
(Instant AP) (RF dot11 g Radio Profile)# max-distance <count>
(Instant AP) (RF dot11 g Radio Profile)# max-tx-power <db>
(Instant AP) (RF dot11 g Radio Profile)# min-tx-power <db>
(Instant AP) (RF dot11 g Radio Profile)# end
(Instant AP)# commit apply

```

To configure 5 GHz radio settings:

```

(Instant AP) (config)# rf dot11a-radio-profile
(Instant AP) (RF dot11a Radio Profile)# beacon-interval <milliseconds>
(Instant AP) (RF dot11a Radio Profile)# legacy-mode
(Instant AP) (RF dot11a Radio Profile)# spectrum-monitor
(Instant AP) (RF dot11a Radio Profile)# spectrum-band <type>
(Instant AP) (RF dot11a Radio Profile)# dot11h
(Instant AP) (RF dot11a Radio Profile)# interference-immunity <level>
(Instant AP) (RF dot11a Radio Profile)# max-distance <count>
(Instant AP) (RF dot11 g Radio Profile)# max-tx-power <db>
(Instant AP) (RF dot11 g Radio Profile)# min-tx-power <db>
(Instant AP) (RF dot11a Radio Profile)# csa-count <count>
(Instant AP) (RF dot11 g Radio Profile)# end
(Instant AP)# commit apply

```

To disable VHT on a 5GHz radio profile:

```

(Instant AP) (config)# rf dot11a-radio-profile
(Instant AP) (RF dot11a Radio Profile)# very-high-throughput-disable
(Instant AP) (RF dot11 g Radio Profile)# end
(Instant AP)# commit apply

```

To view the radio configuration:

```

(Instant AP)# show radio config

Legacy Mode:enable
Beacon Interval:100
802.11d/802.11h:enable
Interference Immunity Level:2
Channel Switch Announcement Count:0
MAX Distance:600
Channel Reuse Type:disable
Channel Reuse Threshold:0
Background Spectrum Monitor:disable

5.0 GHz:
Legacy Mode:enable
Beacon Interval:100
802.11d/802.11h:enable
Interference Immunity Level:2
Channel Switch Announcement Count:2
MAX Distance:600
Channel Reuse Type:disable
Channel Reuse Threshold:0
Background Spectrum Monitor:disable
Standalone Spectrum Band:5ghz-upper

```

Configuring Cell Size Reduction using the CLI

The Cell Size Reduction feature allows you to manage dense deployments and to increase overall system performance and capacity by shrinking an OAW-IAPs receive coverage area, thereby minimizing co-channel interference and optimizing channel reuse.

The default 0 dB reduction allows the radio to retain its current default Rx sensitivity value.

Values from 1 dB - 55 dB reduce the power level that the radio can hear by that amount. If you configure this feature to use a non-default value, you must also reduce the radio's transmission (Tx) power to match its new received (Rx) power level. Failure to match a device's Tx power level to its Rx power level can result in a configuration that allows the radio to send messages to a device that it cannot hear.

To configure Cell Size Reduction for 2.4 GHz radio profile in the CLI:

```
(Instant AP) (config)# rf dot11g-radio-profile
(Instant AP) (RF dot11 g Radio Profile)# cell-sie-reduction <reduction>
(Instant AP) (RF dot11 g Radio Profile)# end
(Instant AP)# commit apply
```

To configure Cell Size Reduction for 5 GHz radio profile in the CLI:

```
(Instant AP) (config)# rf dot11g-radio-profile
(Instant AP) (RF dot11 g Radio Profile)# cell-sie-reduction <reduction>
(Instant AP) (RF dot11 g Radio Profile)# end
(Instant AP)# commit apply
```

This chapter provides the following information:

- [Deep Packet Inspection on page 268](#)
- [Enabling Application Visibility on page 268](#)
- [Application Visibility on page 269](#)
- [Enabling URL Visibility on page 274](#)
- [Configuring ACL Rules for Application and Application Categories on page 274](#)
- [Configuring Web Policy Enforcement Service on page 277](#)

Deep Packet Inspection

AppRF is Alcatel-Lucent's custom built Layer 7 firewall capability. It consists of an on-board deep packet inspection and a cloud-based Web Policy Enforcement service that allows creating firewall policies based on types of application. The web policy enforcement capabilities require the OAW-IAP to have a web policy enforcement subscription. For more information on subscription, contact the Alcatel-Lucent Sales Team.

OAW-IAPs with DPI capability analyze data packets to identify applications in use and allow you to create access rules to determine client access to applications, application categories, web categories and website URLs based on web reputation. You can also define traffic shaping policies such as bandwidth control and QoS per application for client roles. For example, you can block bandwidth monopolizing applications on a guest role within an enterprise.

The AppRF feature provides application visibility for analyzing client traffic flow. OAW-IAPs support both the power of in-device packet flow identification and dynamically updated cloud-based web categorization.

For more information on DPI ACLs and AppRF visibility, see the following topics:

- [Enabling Application Visibility on page 268](#)
- [Application Visibility on page 269](#)
- [Configuring ACL Rules for Application and Application Categories on page 274](#)
- [Configuring Web Policy Enforcement Service on page 277](#)

Enabling Application Visibility

Enabling AppRF visibility allows you to view the AppRF statistics for an OAW-IAP or the clients associated with an OAW-IAP. Full URL visibility for http sessions fed to ALE is exposed as northbound APIs which can be consumed by URL analytical engines for advanced client URL data mining and analytics.

You can enable AppRF visibility through the AOS-W Instant UI or CLI:

In the AOS-W Instant UI

1. Navigate to **System>General**.
2. Select **All** from the **AppRF visibility** drop-down to view both application and web categories charts or either **App** or **WebCC** to view their DPI graphs separately.
3. Click **OK**.

In the CLI

To enable AppRF visibility:

```
(Instant AP) (config)# dpi [app|webcc]
(Instant AP) (config)# end
(Instant AP)# commit apply
```

Application Visibility

The AppRF graphs are based on Deep Packet Inspection (DPI) application and Web Policy Enforcement service, which provides application traffic summary for the client devices associated with an OAW-IAP. The **AppRF** link above the activity panel of the dashboard is displayed only if **AppRF visibility** is enabled in the **System** window.

The following figure provides a view of the AppRF dashboard:

Figure 58 AppRF Dashboard

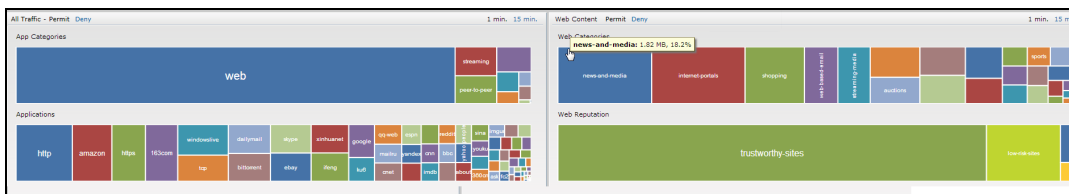

The AppRF dashboard presents four different graph areas with data graphs on all client traffic and content filters based on App Category, Web Category and Web Reputation. Click on each category to view real-time client traffic data or usage trend in the last 15 minutes or 1 minute view.

The **permit** and **deny** monitoring tabs in the All Traffic and Web Content sections provide enforcement visibility support.

- **Permit** represents the allowed or permitted traffic on the OAW-IAP.
- **Deny** represents all the blocked URLs and traffic .



The application charts are not supported on OAW-IAP104/105, OAW-IAP134/135, OAW-IAP175P/175AC, and OAW-RAP3WN/3WNP platforms. Only the web category charts are displayed for these OAW-IAP models.

Application Category Charts

The application category chart displays details on the client traffic towards the application categories. On clicking in the rectangle area, you can view the following graphs and toggle between the chart and list views.

Figure 59 Application Categories Chart - Client View

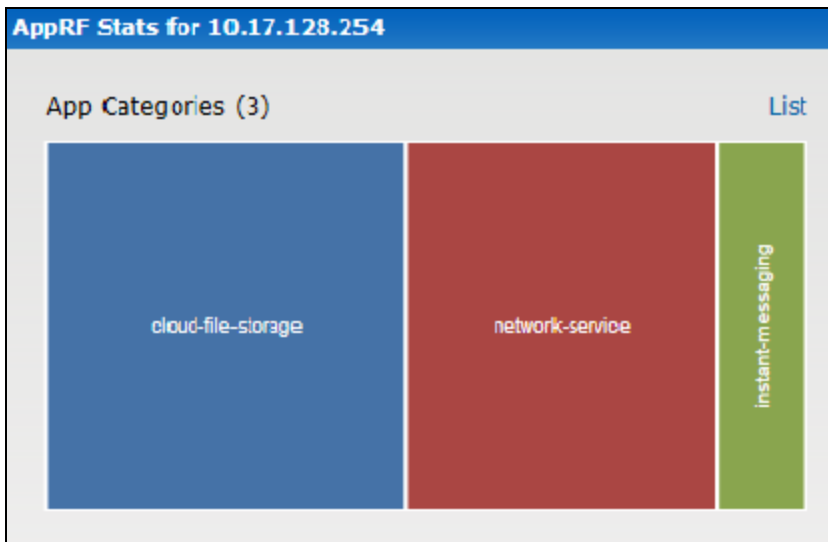

Figure 60 Application Categories List - Client View

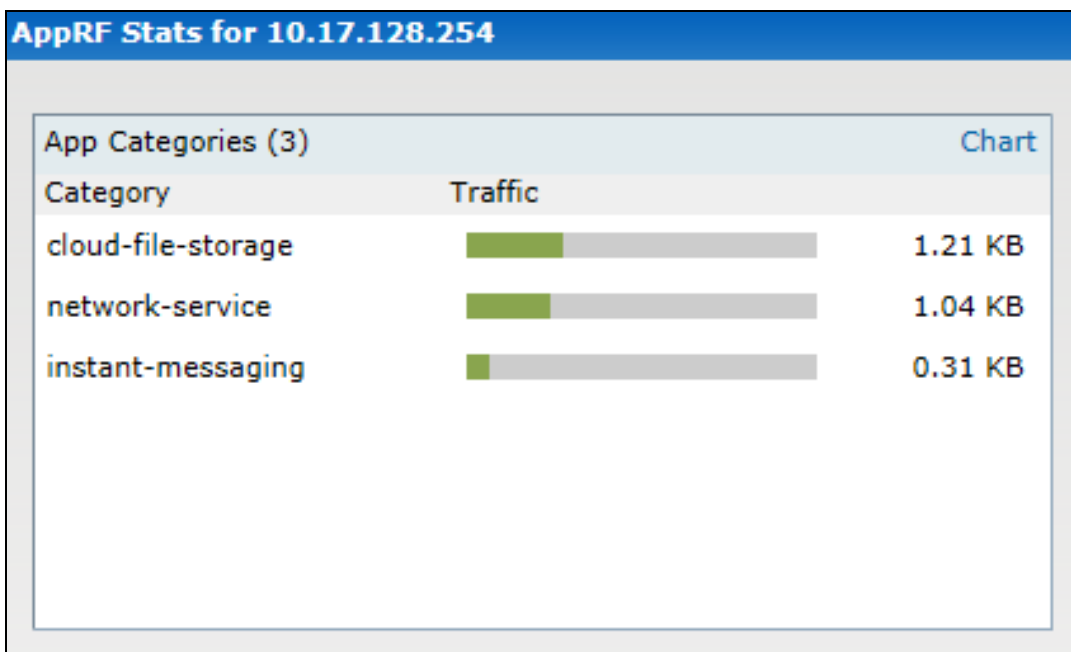
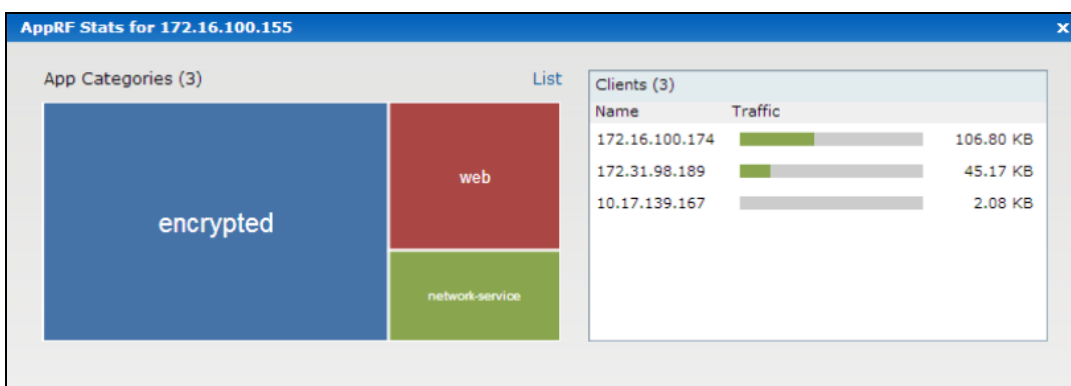

Figure 61 Application Category Chart - AP View



Application Charts

The application chart displays details on the client traffic towards the applications. On clicking in the rectangle area, you can view the following graphs and toggle between the chart and list views.

Figure 62 Application Chart - Client View

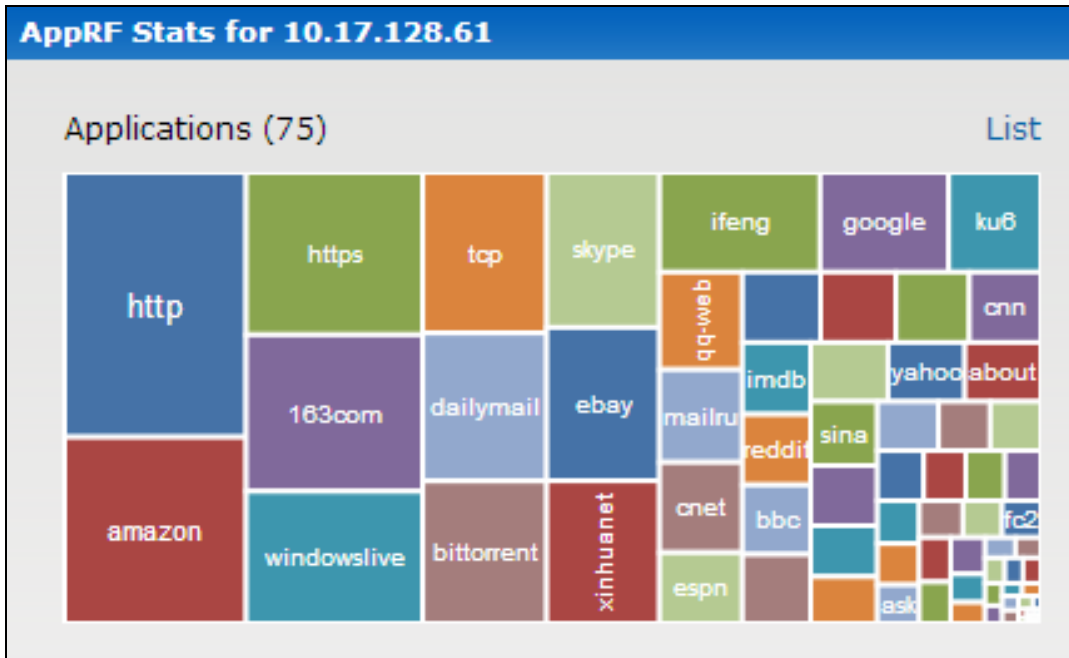

Figure 63 Application List - Client View

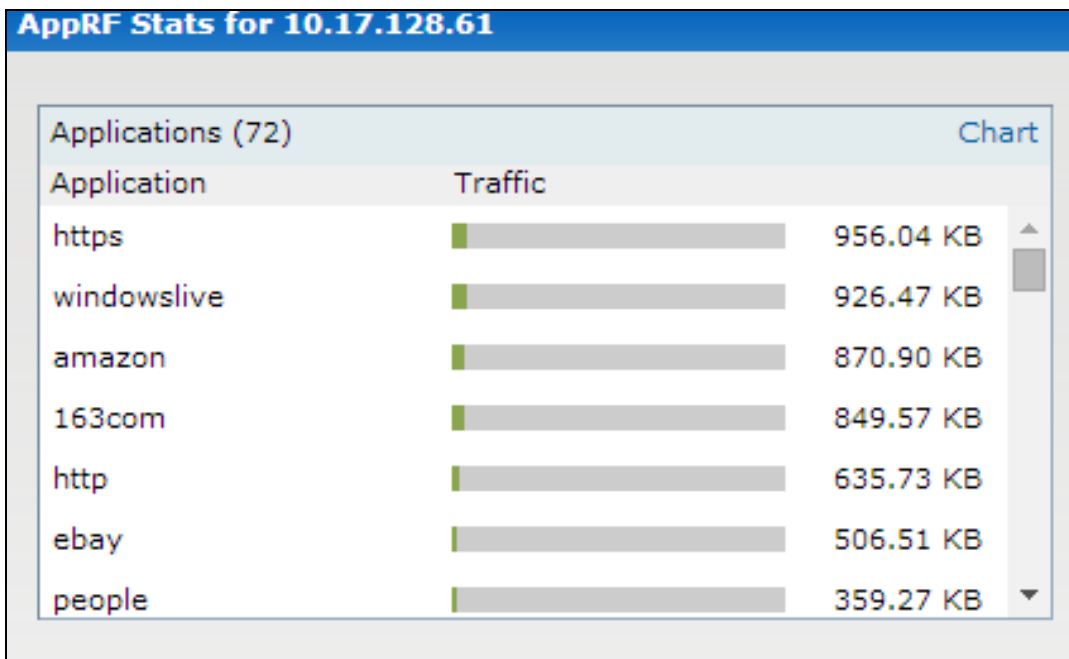
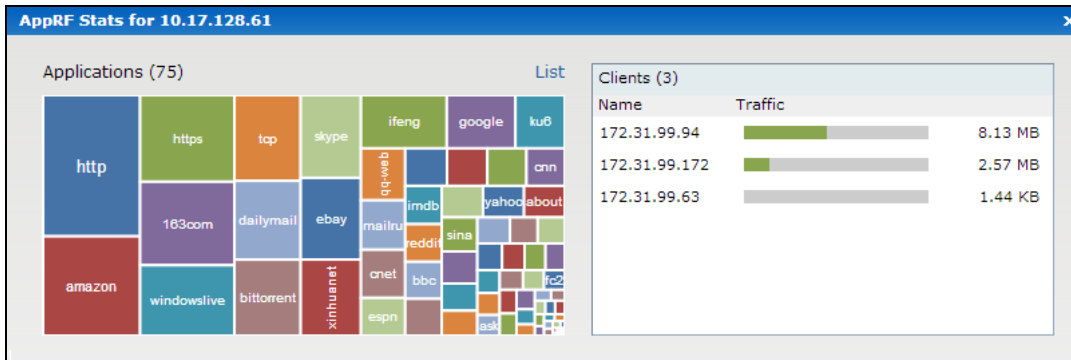

Figure 64 Application Chart - AP View



Web Categories Charts

The web categories chart displays details about the client traffic to the web categories. On clicking in the rectangle area, you can view the following graphs and toggle between the chart and list views.

Figure 65 Web Categories Chart - Client View

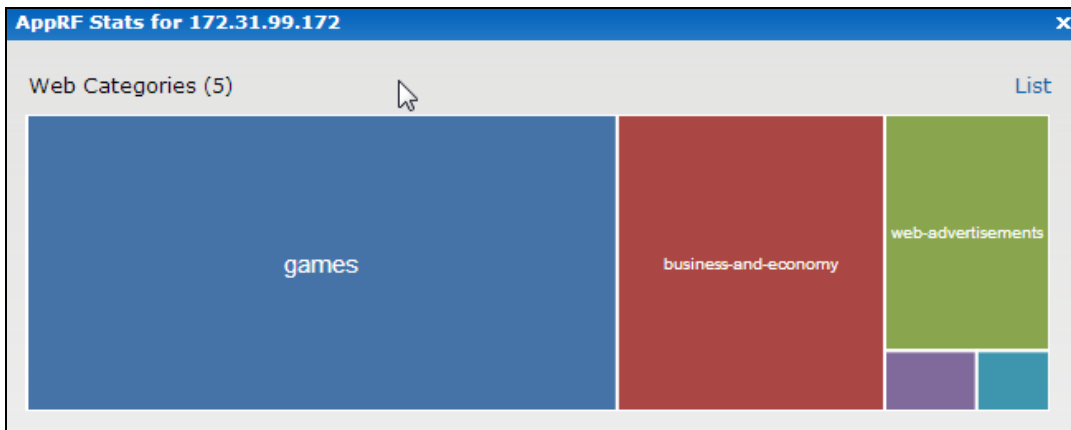

Figure 66 Web Categories List - Client View

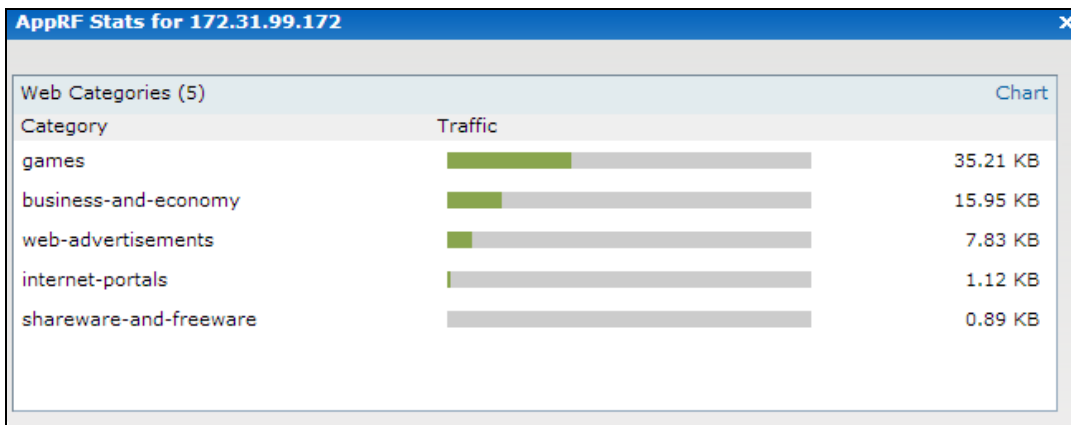
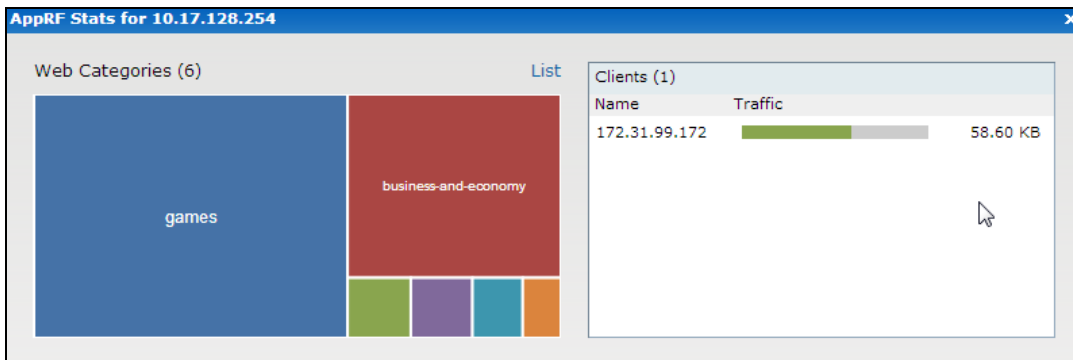

Figure 67 Web Categories Chart - AP View



Web Reputation Charts

The web reputation chart displays details about the client traffic to the URLs with that are assigned a security ratings. On clicking in the rectangle area, you can view the following graphs and toggle between the chart and list views.

Figure 68 Web Reputation Chart - Client View

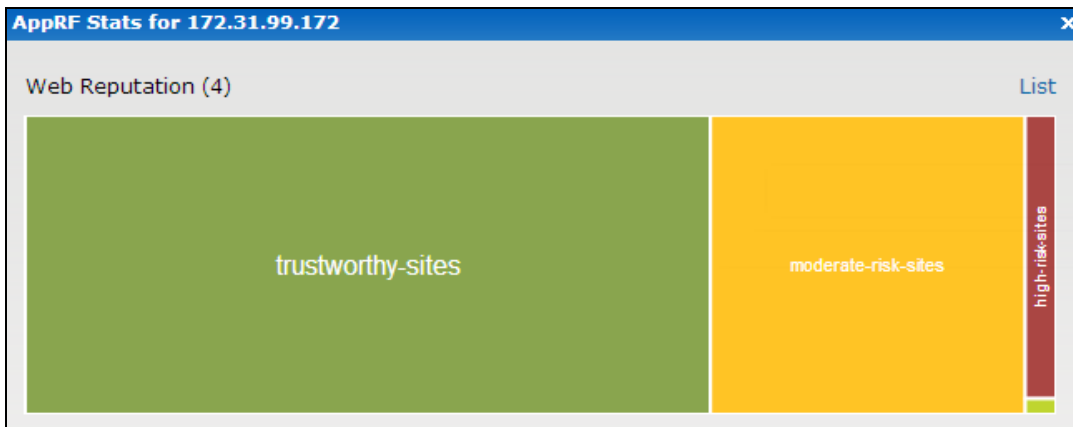

Figure 69 Web Reputation List - Client View

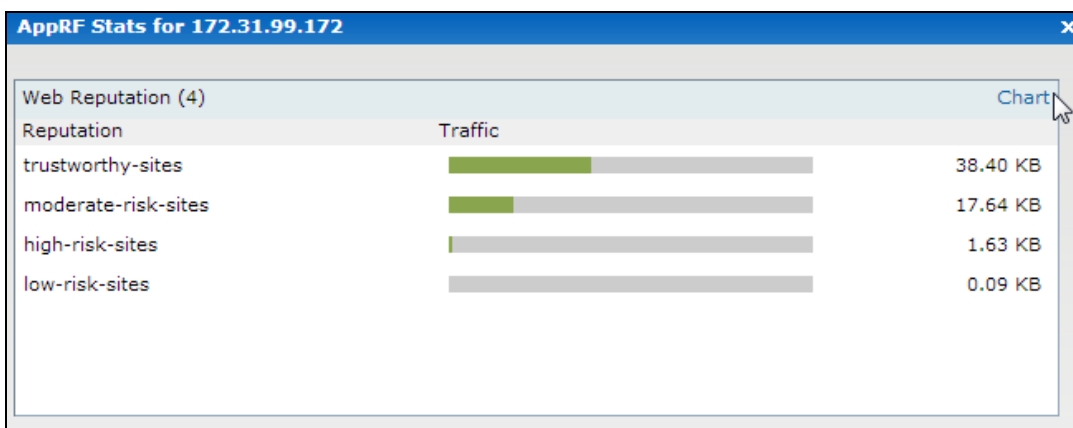
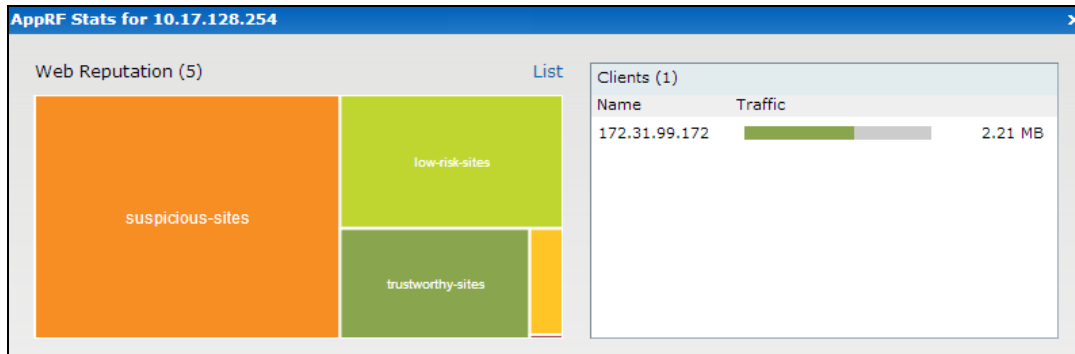

Figure 70 Web Reputation Chart - AP View



Enabling URL Visibility

Enabling URL visibility allows the OAW-IAP to extract the full URL information of the http and https sessions and periodically log them on the ALE server. Full url visibility for http sessions fed to ALE are exposed as Northbound API's, and are used by URL analytical engines for advanced client URL data mining and analysis.

You can enable URL visibility through the AOS-W Instant UI or CLI:

In the AOS-W Instant UI

1. Navigate to **System>General**.
2. Set the **URL visibility** to **Enabled** from the drop-down.
3. Click **OK**.

In the CLI

To enable URL visibility:

```
(Instant AP) (config)# url-visibility
(Instant AP) (config)# end
(Instant AP)# commit apply
```

Configuring ACL Rules for Application and Application Categories

This section describes the procedure for configuring access rules based on application and application categories. The Application and Application rules utilize the on-board DPI engine. For information on:

- Configuring access rules to control access to network services, see [Configuring ACL Rules for Network Services on page 189](#).
- Configuring access rules based on web categories and web reputation, see [Configuring Web Policy Enforcement Service on page 277](#)

In the AOS-W Instant UI

To configure ACL rules for a user role:

1. Navigate to the **Security > Roles** tab. The **Roles** tab contents are displayed.
You can also configure access rules for a wired or wireless client through the WLAN wizard (**Network** tab>**WLAN SSID**> **Edit**>**Edit WLAN** > **Access**) or the Wired profile (**More** > **Wired**>**Edit**> **Edit Wired Network**> **Access**) window.
2. Select the role for which you want to configure access rules.
3. In **Access rules** section, click **New** to add a new rule. The **New Rule** window is displayed.
4. Ensure that the rule type is set to **Access Control**

5. To configure access to applications or application category, select a service category from the following list:
 - Application
 - Application category



Configuring access rules based on application and application category is not supported on OAW-IAP104/105, OAW-IAP134/135, and OAW-RAP3WN/3WNP platforms.

6. Based on the selected service category, configure the following parameters:

Table 55: Access Rule Configuration Parameters

Service Category	Description
Application	Select the applications to which you want to allow or deny access.
Application category	<p>Select any of the following application categories to which you want to allow or deny access:</p> <ul style="list-style-type: none"> • antivirus • authentication • cloud-file-storage • collaboration • encrypted • enterprise-apps • gaming • im-file-transfer • instant-messaging • mail-protocols • mobile-app-store • network-service • peer-to-peer • social-networking • standard • streaming • thin-client • tunneling • unified-communications • web • Webmail
Application Throttling	<p>Application throttling allows you to set a bandwidth limit for an application, application category, web category, or for sites based on their web reputation. For example, you can limit the bandwidth rate for video streaming applications such as YouTube or Netflix, or assign a low bandwidth to high risk sites. If your OAW-IAP model does not support configuring access rules based on application or application category, you can create a rule based on web category or website reputation and assign bandwidth rates.</p>

Table 55: Access Rule Configuration Parameters

Service Category	Description
	<p>To specify a bandwidth limit:</p> <ol style="list-style-type: none"> 1. Select the Application Throttling checkbox. 2. Specify the downstream and upstream rates in Kbps.
Action	<p>Select any of following actions:</p> <ul style="list-style-type: none"> • Select Allow to allow access users based on the access rule. • Select Deny to deny access to users based on the access rule. • Select Destination-NAT to allow changes to destination IP address. • Select Source-NAT to allow changes to the source IP address. <p>The destination-nat and source-nat actions apply only to the network services rules.</p>
Destination	<p>Select a destination option for the access rules for network services, applications, and application categories. You can allow or deny access to any the following destinations based on your requirements.</p> <ul style="list-style-type: none"> • to all destinations— Access is allowed or denied to all destinations. • to a particular server—Access is allowed or denied to a particular server. After selecting this option, specify the IP address of the destination server. • except to a particular server—Access is allowed or denied to servers other than the specified server. After selecting this option, specify the IP address of the destination server. • to a network—Access is allowed or denied to a network. After selecting this option, specify the IP address and netmask for the destination network. • except to a network—Access is allowed or denied to networks other than the specified network. After selecting this option, specify the IP address and netmask of the destination network. • to domain name—Access is allowed or denied to the specified domains. After selecting this option, specify the domain name in the Domain Name text box. • to master IP—Access is allowed or denied to the master IP address.
Log	<p>Select this checkbox to create a log entry when this rule is triggered. AOS-W Instant supports firewall based logging function. Firewall logs on the OAW-IAPs are generated as security logs.</p>
Blacklist	<p>Select the Blacklist checkbox to blacklist the client when this rule is triggered. The blacklisting lasts for the duration specified as Auth failure blacklist time on the Blacklisting tab of the Security window. For more information, see Blacklisting Clients on page 183.</p>

Table 55: Access Rule Configuration Parameters

Service Category	Description
Disable scanning	Select Disable scanning checkbox to disable ARM scanning when this rule is triggered. The selection of the Disable scanning applies only if ARM scanning is enabled, For more information, see Configuring Radio Settings on page 264 .
DSCP tag	Select the DSCP tag checkbox to specify a DSCP value to prioritize traffic when this rule is triggered. Specify a value within the range of 0 to 63. To assign a higher priority, specify a higher value.
802.1p priority	Select the 802.1p priority checkbox to specify an 802.1p priority. Specify a value between 0 and 7. To assign a higher priority, specify a higher value.

3. Click **OK** and then click **Finish**.

In the CLI

To configure access rules:

```
(Instant AP) (config)# wlan access-rule <access-rule-name>
(Instant AP) (Access Rule <Name>)#rule <dest> <mask> <match/invert> {app <app> {permit|deny}
|appcategory <appgrp>}[<option1...option9>]
(Instant AP) (Access Rule <Name>)# end
(Instant AP)# commit apply
```

Example

```
(Instant AP) (config)# wlan access-rule employee
(Instant AP) (Access Rule "employee")# rule any any match app youtube permit throttle-
downstream 256 throttle-up 256
(Instant AP) (Access Rule "employee")# rule any any match appcategory collaboration permit
(Instant AP) (Access Rule "employee")# end
(Instant AP)# commit apply
```

Configuring Web Policy Enforcement Service

You can configure Web Policy Enforcement service on an OAW-IAP to block certain categories of websites based on your organization specifications by defining ACL rules either through the AOS-W Instant UI or CLI.

In the AOS-W Instant UI

1. Navigate to **Security >Roles**.
2. Select any WLAN SSID or wired profile role, and click **New** in the Access Rules section. The **New Rule window** appears.
3. Select the rule type as **Access Control**.
4. To set an access policy based on the web category:
 - a. Under **Services**, select **Web category** and expand the **Web categories** drop-down.

Figure 71

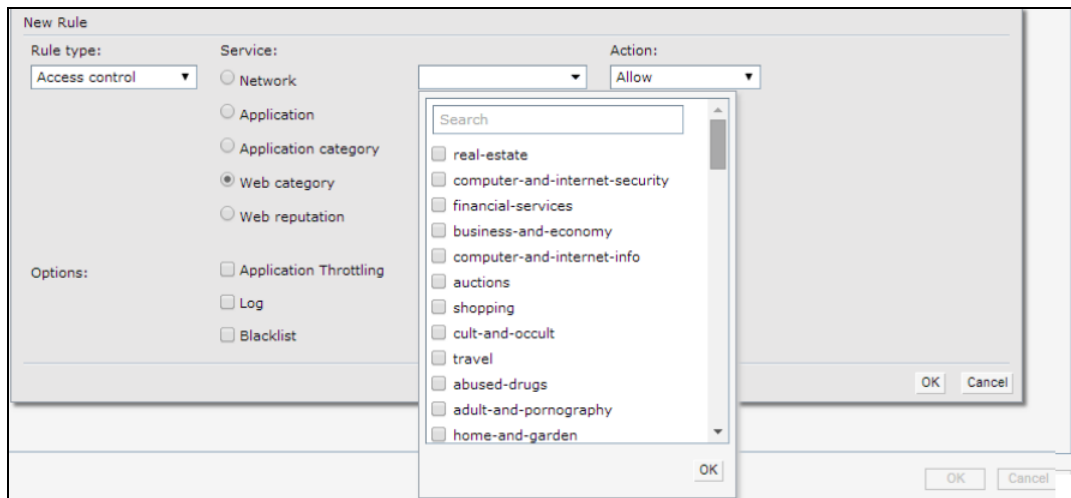

- b. Select the categories to which you want to deny or allow access. You can also search for a web category and select the required option.
 - c. From the **Action** drop-down, select **Allow** or **Deny** as required.
 - d. Click **OK**.
5. To filter access based on the security ratings of the website:
- a. Select **Web reputation** under **Services**.
 - b. Move the slider to the required security rating level. Move the slider to select a specific web reputation value to deny access to websites with a reputation value lower than or equal to the configured value or to permit access to websites with a reputation value higher than or equal to the configured value. The following options are available:
 - Trustworthy - These are well known sites with strong security practices and may not expose the user to security risks. There is a very low probability that the user will be exposed to malicious links or payloads.
 - Low risk - These are benign sites and may not expose the user to security risks. There is a low probability that the user will be exposed to malicious links or payloads.
 - Moderate risk - These are generally benign sites, but may pose a security risk. There is some probability that the user will be exposed to malicious links or payloads.
 - Suspicious - These are suspicious sites. There is a higher than average probability that the user will be exposed to malicious links or payloads.
 - High risk - These are high risk sites. There is a high probability that the user will be exposed to malicious links or payloads.
 - c. From the **Action** drop-down, select **Allow** or **Deny** as required.



For a complete list of categories and information about each of these categories, visit the BrightCloud® Security Services web page at <http://www.brightcloud.com/tools/change-request-url-ip.php>.

6. To set a bandwidth limit based on web category or web reputation score, select **Application Throttling** checkbox and specify the downstream and upstream rates in Kbps. For example, you can set a higher bandwidth for trusted sites and a low bandwidth rate for high risk sites.
7. If required, select the following checkboxes:
 - **Log**—Select this checkbox if you want a log entry to be created when this rule is triggered. AOS-W Instant supports firewall based logging function. Firewall logs on the OAW-IAPs are generated as security logs.

- **Blacklist**—Select the **Blacklist** checkbox to blacklist the client when this rule is triggered. The blacklisting lasts for the duration specified as **Auth failure blacklist time** on the Blacklisting tab of the **Security** window. For more information, see [Blacklisting Clients on page 183](#).
 - **Disable scanning**—Select **Disable scanning** checkbox to disable ARM scanning when this rule is triggered. The selection of the **Disable scanning** applies only if ARM scanning is enabled, For more information, see [Configuring Radio Settings on page 264](#).
 - **DSCP tag**—Select the **DSCP tag** checkbox to specify a DSCP value to prioritize traffic when this rule is triggered. Specify a value within the range of 0 to 63. To assign a higher priority, specify a higher value.
 - **802.1p priority**—Select the **802.1p priority** checkbox to specify an 802.1p priority. Specify a value between 0 and 7. To assign a higher priority, specify a higher value.
8. Click **OK** to save the rules.
 9. Click **OK** on the **Roles** tab to save the changes to the role for which you defined ACL rules.

In the CLI

To control access based on web categories and security ratings:

```
(Instant AP) (config)# wlan access-rule <access_rule>
(Instant AP) (Access Rule "<access-rule>")# rule <dest> <mask> <match> webcategory <webgrp>
{permit| deny}[<option1...option9>]
(Instant AP) (Access Rule "<access-rule>")# rule <dest> <mask> <match> webreputation <webrep>
{permit|deny}[<option1...option9>]
(Instant AP) (Access Rule "<access-rule>")# end
(Instant AP)# commit apply
```

Example

```
(Instant AP) (config)# wlan access-rule URLFilter
(Instant AP) (Access Rule "URLFilter")# rule any any match webcategory gambling deny
(Instant AP) (Access Rule "URLFilter")# rule any any match webcategory training-and-tools
permit
(Instant AP) (Access Rule "URLFilter")# rule any any match webreputation suspicious-sites deny
(Instant AP) (Access Rule "URLFilter")# end
(Instant AP)# commit apply
```

This chapter the steps required to configure voice and video services on an OAW-IAP for Voice over IP (VoIP) devices, including Session Initiation Protocol (SIP), Spectralink Voice Priority (SVP), H323, SCCP, Vocera, and Alcatel NOE phones, clients running Microsoft OCS, and Apple devices running the Facetime application.

This section includes the following topics:

- [Wi-Fi Multimedia Traffic Management on page 280](#)
- [QoS for Microsoft Office Lync on page 283](#)

Wi-Fi Multimedia Traffic Management

Wi-Fi Multimedia (WMM), is a Wi-Fi Alliance specification based on the IEEE 802.11 e wireless Quality of Service (QoS) standard. WMM works with 802.11 a, b, g, and n physical layer standards.

WMM supports the following access categories (ACs):

- Voice
- Video
- Best effort
- Background

The following table shows the mapping of the WMM access categories to 802.1p priority values. The 802.1p priority value is contained in a two-byte QoS control field in the WMM data frame.

Table 56: *WMM AC to 802.1p Priority Mapping*

802.1p Priority	WMM Access Category
1	Background
2	
0	Best effort
3	
4	Video
5	
6	Voice
7	

In a non-WMM or hybrid environment, where some clients are not WMM-capable, you can configure an SSID with higher values for best effort and voice ACs, to allocate a higher bandwidth to clients transmitting best effort and voice traffic.

Configuring WMM for Wireless Clients

You can configure WMM for wireless clients by using the UI or CLI.

In the AOS-W Instant UI

1. Navigate to the WLAN wizard (click **Network>New** or **Network> Select the WLAN SSID>edit**).
2. Click **Show advanced options** under **WLAN Settings**.
3. Specify a percentage value for the following WMM access categories in the corresponding **Share** field. You can allocate a higher bandwidth for voice and video traffic than other types of traffic based on the network profile.
 - **Background WMM**—Allocates bandwidth for background traffic such as file downloads or print jobs.
 - **Best effort WMM** —Allocates bandwidth or best effort traffic such as traffic from legacy devices or traffic from applications or devices that do not support QoS.
 - **Video WMM**—Allocates bandwidth for video traffic generated from video streaming.
 - **Voice WMM**—Allocates bandwidth for voice traffic generated from the incoming and outgoing voice communication.

In a non-WMM or hybrid environment, where some clients are not WMM-capable, you can allocate higher values for **Best effort WMM** and **Voice WMM** to allocate a higher bandwidth to clients transmitting best effort and voice traffic.

4. Click **Next** and complete the configuration as required.

In the CLI

```
(Instant AP) (config)# wlan ssid-profile <name>
(Instant AP) (SSID Profile <name>)# wmm-background-share <share>
(Instant AP) (SSID Profile <name>)# wmm-best-effort-share <share>
(Instant AP) (SSID Profile <name>)# wmm-video-share <share>
(Instant AP) (SSID Profile <name>)# wmm-voice-share <share>
(Instant AP) (SSID Profile <name>)# end
(Instant AP)# commit apply
```

Mapping WMM ACs and DSCP Tags

The IEEE 802.11e standard defines the mapping between WMM ACs and Differentiated Services Codepoint (DSCP) tags. You can customize the mapping values between WMM ACs and DSCP tags to prioritize various traffic types and apply these changes to a WMM-enabled SSID profile.

DSCP classifies packets based on network policies and rules. The following table shows the default WMM AC to DSCP mappings and the recommended WMM AC to DSCP mappings.

Table 57: WMM-DSCP Mapping

DSCP Value	WMM Access Category
8	Background
16	
0	Best effort
24	

DSCP Value	WMM Access Category
32	Video
40	
48	Voice
56	

By customizing WMM AC mappings, all packets received are matched against the entries in the mapping table and prioritized accordingly. The mapping table contains information for upstream (client to OAW-IAP) and downstream (OAW-IAP to client) traffic.

You can configure different WMM to DSCP mapping values for each WMM AC when configuring an SSID profile either in the AOS-W Instant UI or CLI.

In the AOS-W Instant UI

1. Navigate to the WLAN wizard (click **Network>New** or **Network> Select the WLAN SSID>edit**).
2. Click **Show advanced options** under **WLAN Settings**.
3. Specify the appropriate DSCP mapping value within a range of 0-63 for the following access categories in the **DSCP mapping** field:
 - **Background WMM**—DSCP mapping for the background traffic.
 - **Best effort WMM**—DSCP mapping for the best-effort traffic.
 - **Video WMM**—DSCP mapping for the video traffic.
 - **Voice WMM**—DSCP mapping for the voice traffic.
4. Click **Next** and complete the configuration as required.

In the CLI

```
(Instant AP) (config)# wlan ssid-profile <name>
(Instant AP) (SSID Profile <name>)# wmm-background-dscp <dscp>
(Instant AP) (SSID Profile <name>)# wmm-best-effort-dscp <dscp>
(Instant AP) (SSID Profile <name>)# wmm-video-dscp <dscp>
(Instant AP) (SSID Profile <name>)# wmm-voice-dscp <dscp>
(Instant AP) (SSID Profile <name>)# end
(Instant AP)# commit apply
```

You can configure up to 8 DSCP mappings values within the range of 0-63. You can also configure a combination of multiple values separated by a comma, for example, **wmm-voice-dscp 46,44,42,41**.

Configuring WMM U-APSD

To extend the battery life and enable powersaving on WLAN clients, OAW-IAPs support Unscheduled Automatic Power Save Delivery (U-APSD) for the clients that support WMM. The U-APSD or the WMM power save feature is enabled by default on all SSIDs. When configured, UAPSD enables a client station to retrieve the unicast QoS traffic buffered in the AP by sending trigger frames. During the association or re-association with the OAW-IAP, the station indicates the WMM Access Categories for which UAPSD is enabled. In the current release, OAW-IAPs support UAPSD on all WMM ACs.

To disable UAPSD on an SSID:

```
(host)# config terminal
(host) (config)# wlan ssid-profile <ssid_profile>
(host) (SSID Profile "<ssid_profile>")# wmm-uapsd-disable
(host) (SSID Profile "<ssid_profile>")# end
```

```
(host)# commit apply
```

To re-enable UAPSD on an SSID:

```
(host)# config terminal
(host)(config)# wlan ssid-profile <ssid_profile>
(host)(SSID Profile "<ssid_profile>")# no wmm-uapsd-disable
(host)(SSID Profile "<ssid_profile>")# end
(host)# commit apply
```

QoS for Microsoft Office Lync

Voice and video devices use a signaling protocol to establish, control, and terminate voice and video calls. These control or signaling sessions are usually permitted using pre-defined ACLs. If the control signaling packets are encrypted, the OAW-IAP cannot determine the dynamic ports are used for voice or video traffic. In these cases, the OAW-IAP has to use an ACL with the classify-media option enabled to identify the voice or video flow based on a deep packet inspection and analysis of the actual traffic. AOS-W Instant identifies and prioritizes voice and video traffic from applications such as Microsoft Office Lync.

Microsoft Office Lync

Microsoft Office Lync uses Session Initiation Protocol (SIP) over TLS to establish, control, and terminate voice and video calls.

The following is an example of the QoS configuration for Microsoft Lync.

```
(Instant AP)(config)#wlan access-rule example_lync_test
(Instant AP)(example_lync_test)# rule any any match tcp 443 443 permit log classify-media
(Instant AP)(example_lync_test)# rule any any match tcp 5060 5060 permit log classify-media
(Instant AP)(example_lync_test)# rule any any match tcp 5061 5061 permit log classify-media
(Instant AP)(example_lync_test)# rule any any match udp 5061 5061 permit log classify-media
(Instant AP)(example_lync_test)# rule any any match any any any permit
```

This chapter provides information on how to configure following services on an OAW-IAP:

- [AirGroup](#)
- [Real Time Location Server \(RTLS\)](#)
- [Analytics and Location Engine \(ALE\)](#)
- [Bluetooth Low Energy \(BLE\) Devices](#)
- [OpenDNS](#)
- [Communications Assistance for Law Enforcement Act \(CALEA\)](#)
- [Palo Alto Network Firewall](#)
- [XML-API Server](#)

AirGroup Configuration

AirGroup provides a unique enterprise-class capability that leverages zero configuration networking to enable AirGroup services from mobile devices in an efficient manner. Zero configuration networking enables service discovery, address assignment, and name resolution for desktop computers, mobile devices, and network services. It is designed for flat, single-subnet IP networks such as wireless networking at home. The users can register their personal devices and define a group of users who can to share the registered devices.

Administrators can register and manage an organization's shared devices such as printers and grant global access to each device, or restrict access according to the username, role, or user location.

In large universities and enterprise networks, it is common for devices to connect to the network across VLANs. As a result, user devices on a specific VLAN cannot discover service that resides on another VLAN. As the addresses used by the protocol are link-scope multicast addresses, each query or advertisement can only be forwarded on its respective VLAN, but not across different VLANs. Broadcast and multicast traffic are usually filtered out from a wireless LAN network to preserve the airtime and battery life. This inhibits the performance of AirGroup services that rely on multicast traffic. Alcatel-Lucent addresses this challenge with AirGroup technology.

The distributed AirGroup architecture allows each OAW-IAP to handle mDNS and DLNA queries and responses individually instead of overloading a Virtual Controller with these tasks. This results in a scalable AirGroup solution.

The AirGroup solution supports both wired and wireless devices. An AirGroup device can be registered by an administrator or a guest user.

1. The AirGroup administrator gives an end user the AirGroup operator role, which authorizes the user to register the client devices on the ClearPass Policy Manager platform.
2. OAW-IAPs maintain information for all AirGroup services. OAW-IAP queries ClearPass Policy Manager to map each device's access privileges to the available services and responds to the query made by a device based on contextual data such as user role, username, and location.

The following figure illustrates how AirGroup enables personal sharing of Apple devices:

Figure 72 AirGroup Enables Personal Device Sharing

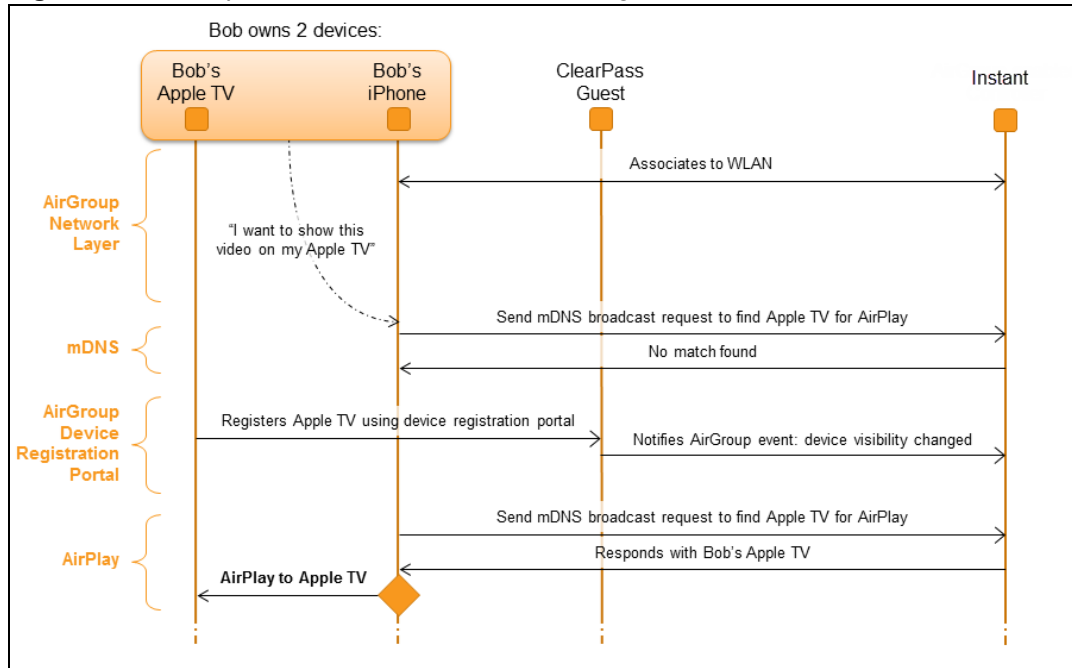

AirGroup is not supported on a 3G and PPPoE uplinks.

Multicast DNS and Bonjour® Services

Bonjour is the trade name for the zero configuration implementation introduced by Apple. It is supported by most of the Apple product lines, including the Mac OS X operating system, iPhone, iPod Touch, iPad, Apple TV, and AirPort Express. Apple AirPlay and AirPrint services are based on the Bonjour protocol and are essential services in campus Wi-Fi networks.

Bonjour can be installed on computers running Microsoft Windows® and is supported by the new network-capable printers. Bonjour is also included with popular software programs such as Apple iTunes, Safari, and iPhoto. Bonjour uses multicast DNS (mDNS) to locate devices and the services offered by these devices.

As shown in the following figure, the OAW-IAP1 discovers AirPrint (P1) and OAW-IAP3 discovers Apple TV (TV1). OAW-IAP1 advertises information about its connected P1 device to the other OAW-IAPs that is OAW-IAP2 and OAW-IAP3. Similarly, OAW-IAP3 advertises TV1 device to OAW-IAP1 and OAW-IAP2. This type of distributed architecture allows any OAW-IAP to respond to its connected devices locally. In this example, the iPad connected to OAW-IAP2 obtains direct response from the same OAW-IAP about the other Bonjour-enabled services in the network.

Figure 73 Bonjour Services and AirGroup Architecture

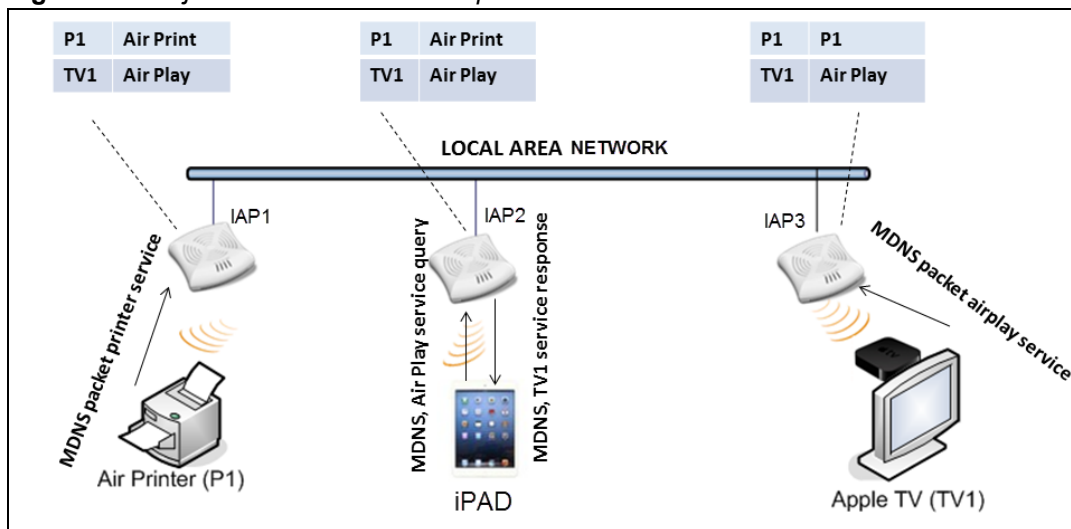

For a list of supported Bonjour services, see [AirGroup Services on page 288](#).

DLNA UPnP Support

In addition to the mDNS protocol, OAW-IAPs now support Universal Plug and Play (UPnP) and DLNA (Digital Living Network Alliance) enabled devices. DLNA is a network standard derived from UPnP, which enables devices to discover the services available in a network. DLNA also provides the ability to share data between the Windows or Android based multimedia devices. All the features and policies applicable to mDNS are extended to DLNA to ensure full interoperability between compliant devices.

In a UPnP based scenario, the following types of devices are available in a network:

- Controlled devices (servers)
- Control points (clients)

When a controlled device joins a network and acquires IP address, it multicasts a number of discovery messages advertising itself, its embedded devices and services. On the other hand, when a control point joins a network, it may multicast a search discovery message searching for interesting devices and services. The devices listening on the multicast address respond if they match the search criteria in the search message.

In a single AP network, the OAW-IAP maintains a cache table containing the list of discovered services in the network. The OAW-IAP also enforces native policies such as disallowing roles and VLANs and the policies defined on ClearPass Policy Manager to determine the devices or services that are allowed and can be discovered in the network. Whenever a search request comes, the AP looks up its cache table and filters based on configured policies and then builds a search response and unicasts it to the requesting device.

In an OAW-IAP cluster, the OAW-IAPs maintain a list of associated UPnP devices and allow the discovery of the associated devices.

The following figure illustrates DLNA UPnP Services and AirGroup Architecture.

Figure 74 DLNA UPnP Services and AirGroup Architecture

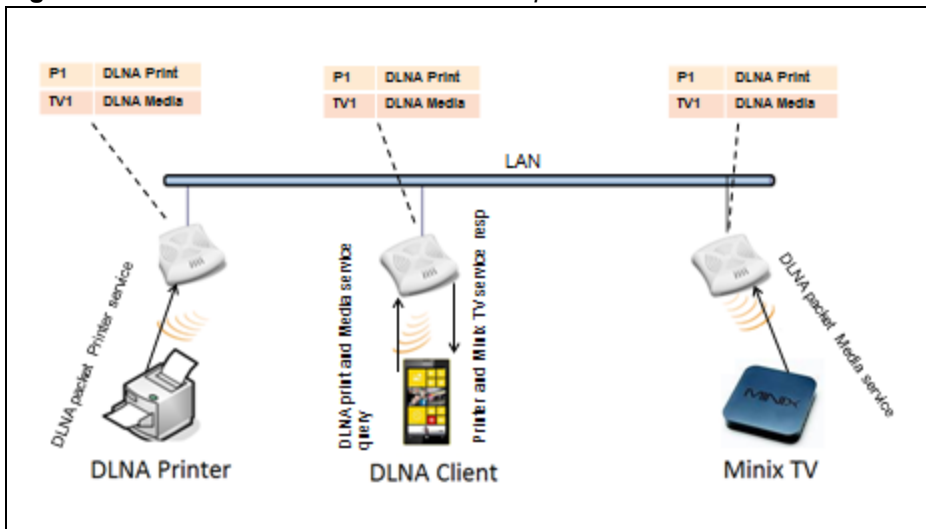

For a list of supported DLNA services, see [AirGroup Services on page 288](#).

AirGroup Features

AirGroup supports the following features:

- Sends unicast responses to mDNS or DLNA queries and reduces the traffic footprint.
- Ensures cross-VLAN visibility and availability of AirGroup devices and services.
- Allows or blocks AirGroup services for all users.
- Allows or blocks AirGroup services based on user roles.
- Allows or blocks AirGroup services based on VLANs.
- Matches devices to their closest services such as printers

AirGroup also enables context awareness for services across the network:

- AirGroup is aware of personal and shared devices. For example, an Apple TV in a dorm room can be associated with the student who owns it or an Apple TV in a meeting room or a printer in a supply room that is available to certain users, such as the marketing department.
- AirGroup is aware of the location of services when ClearPass Policy Manager support is enabled. For example, depending on proximity, a user would be presented with the closest printer instead of all the printers in the building.
- When configured, AirGroup enables a client to perform a location-based discovery. For example, when a client roams from one AOS-W Instant cluster to another, it can discover devices available in the new cluster to which the client is currently connected.

The following figure shows an example of a higher-education environment with shared, local, and personal services available to mobile devices.

Figure 75 AirGroup in a Higher-Education Environment

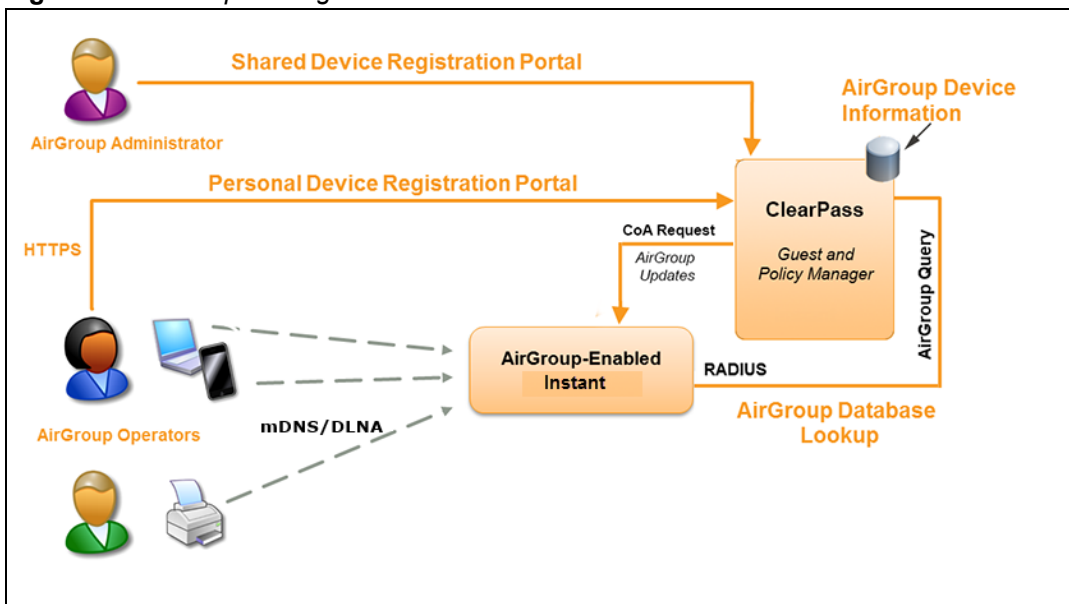

When AirGroup discovers a new device, it interacts with ClearPass Policy Manager to obtain the shared attributes such as shared location and role. However, the current versions of OAW-IAPs do not support the enforcement of shared location policy.

AirGroup Services

AirGroup supports zero configuration services. The services are pre-configured and are available as part of the factory default configuration. The administrator can also enable or disable any or all services by using the AOS-W Instant UI or CLI.

The following services are available for OAW-IAP clients:

- **AirPlay™**— Apple® AirPlay allows wireless streaming of music, video, and slideshows from your iOS device to Apple TV® and other devices that support the AirPlay feature.
- **AirPrint™**— Apple AirPrint allows you to print from an iPad®, iPhone®, or iPod® Touch directly to any AirPrint compatible printers.
- **iTunes**—The iTunes service is used by iTunes Wi-Fi sync and iTunes home-sharing applications across all Apple devices.
- **RemoteMgmt**—The RemoteMgmt service allows remote login, remote management, and FTP utilities on Apple devices.
- **Sharing**— The Sharing service allows applications such as disk sharing and file sharing among Apple devices.
- **Chat**— The iChat® (Instant Messenger) application on Apple devices uses this service.
- **ChromeCast**—ChromeCast service allows you to use a ChromeCast device to play audio or video content on a high definition television by streaming content through Wi-Fi from the Internet or local network.
- **DLNA Media**—Applications such as Windows Media Player use this service to browse and play media content on a remote device.
- **DLNA Print**—This service is used by printers that support DLNA.



In the Instant 6.4.0.2-4.1 release, it is recommended to have a maximum of upto 80 AirGroup servers in the network

For more information on configuring AirGroup services, see [Configuring AirGroup and AirGroup Services on an OAW-IAP on page 290](#).

AirGroup Components

AirGroup leverages key elements of the Alcatel-Lucent solution portfolio including operating system software for AOS-W Instant, ClearPass Policy Manager, and the VLAN-based or role-based filtering options offered by the AirGroup services. The components that make up the AirGroup solution include the AOS-W Instant, ClearPass Policy Manager, and ClearPass Guest. The version requirements are described in the following table:

Table 58: AOS-W Instant, ClearPass Policy Manager, and ClearPass Guest Requirements

Component	Minimum Version for mDNS Services	Minimum Version for DLNA Services
AOS-W Instant	6.2.0.0-3.2.0.0	6.4.0.2-4.1
ClearPass Guest software	5.2	6.2
ClearPass Guest Services plugin	6.2.0	6.3.0



Starting from ClearPass version 6.0, the ClearPass Guest and the AirGroup Services plug-in are integrated into a single platform.

AirGroup maintains seamless connectivity between clients and services across VLANs and SSIDs. The following table summarizes the filtering options supported by AOS-W Instant:

Table 59: AirGroup Filtering Options

Features	AOS-W Instant Deployment Models	
	Integrated	Integrated with ClearPass Policy Manager
Allow mDNS and DLNA traffic to propagate across subnets/VLANs	Yes	Yes
Limit mDNS and DLNA traffic on the network	Yes	Yes
VLAN based AirGroup service policy enforcement	Yes	Yes
User-role based AirGroup service policy enforcement	Yes	Yes
Portal to self register personal leaves	No	Yes
Device owner based policy enforcement	No	Yes
Shared user list based policy enforcement	No	Yes
Shared role list based policy enforcement	No	Yes

ClearPass Policy Manager and ClearPass Guest Features

ClearPass Policy Manager and ClearPass Guest support the following features:

- Registration portal for WLAN users to register their personal devices.

- Registration portal for WLAN administrators to register shared devices.
- Operator-defined *personal* AirGroup to specify a list of other users who can share devices with the operator.
- Administrator defined username, user role, and location attributes for shared devices.

Configuring AirGroup and AirGroup Services on an OAW-IAP

You can configure AirGroup services, using the AOS-W Instant UI or CLI.

In the AOS-W Instant UI

To enable AirGroup and its services:

1. Click the **More > Services** link at the top right corner of the AOS-W Instant main window.
2. Click the **Air Group** tab. The **Air Group** tab details are displayed.

Figure 76 AirGroup Configuration

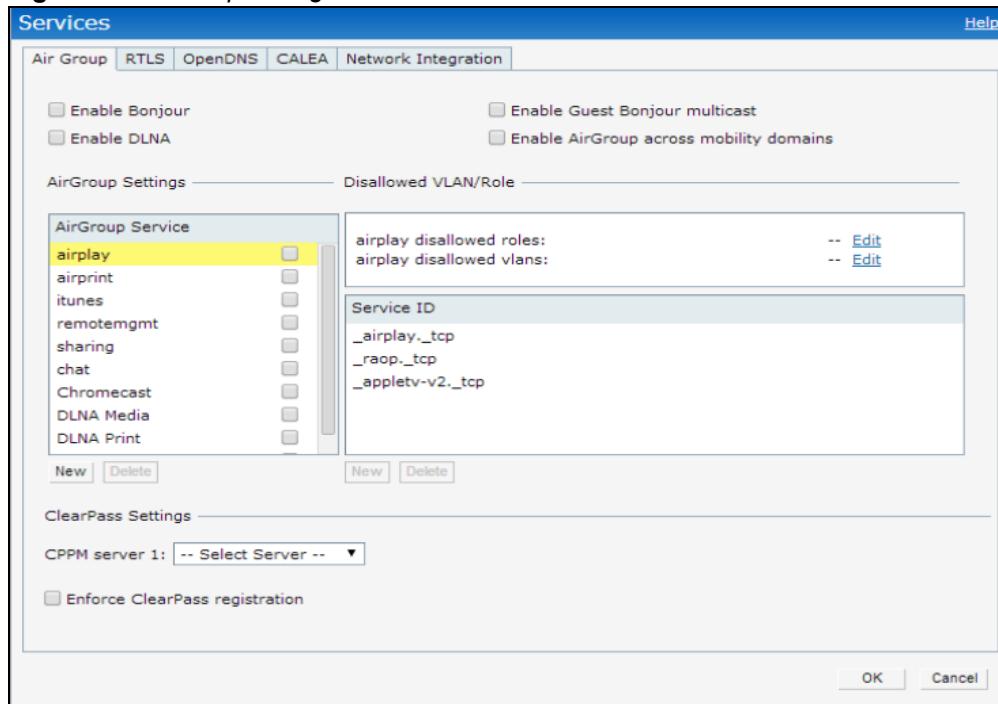

3. To enable support for Bonjour services, select the **Enable Bonjour** checkbox and select the AirGroup services related to Bonjour as required.
4. To enable DLNA support, select the **Enable DLNA** checkbox and select the DLNA services.
5. To allow the users to use Bonjour services enabled in a guest VLAN, select **Enable Guest Bonjour multicast**. When this checkbox is enabled, the Bonjour devices are visible only in the guest VLAN and AirGroup will not discover or enforce policies in guest VLAN.
6. Select the **Enable Air Group across mobility domains** checkbox to enable inter-cluster mobility. When enabled, the OAW-IAP shares the mDNS database information with the other clusters. The DNS records in the Virtual Controller can be shared with the all the Virtual Controllers configured for L3 Mobility. By default, this feature is disabled. To define clusters, go to **System > L3 Mobility** tab.
7. Ensure that the required AirGroup services are selected. To add any service, click **New** and add. To allow all services, select **allowall**. If a custom service is added, you can add a corresponding service ID by clicking **New** under **Service ID**.



If the OAW-IAP is upgraded to current release and if Bonjour is enabled, ensure that the corresponding

Bonjour services are selected.

AOS-W Instant supports the use of upto 6 custom services.

8. Based on the services configured, you can block any user roles from accessing an AirGroup service and restrict the AirGroup servers connected to a specific set of VLANs from being discovered . The user roles and VLANs marked as disallowed are prevented from accessing the corresponding AirGroup service. You can create a list of disallowed user roles and VLANs for all AirGroup services configured on the OAW-IAP. For example, if the AirPlay service is selected, the **edit** links for the **airplay disallowed roles** and **airplay disallowed vlans** are displayed. Similarly, if sharing service is selected, the **edit** links for the **sharing disallowed roles** and **sharing disallowed vlans** are displayed.
 - To select block user roles from accessing an AirGroup service, click the corresponding **edit** link and select the user roles for which you want to restrict access. By default, an AirGroup service is accessible by all user roles configured in your OAW-IAP cluster.
 - To select VLANs from allowing access to an AirGroup service, click the corresponding **edit** link and select the VLANs to exclude. By default, the AirGroup services are accessible by users or devices in all VLANs configured in your OAW-IAP cluster.
9. **ClearPass Settings**— Use this section to configure the ClearPass Policy Manager server, CoA server, and enforce ClearPass registering.
 - **CPPM server 1**— Indicates the ClearPass Policy Manager server information for AirGroup policy.
 - **Enforce ClearPass registering**— When enabled, only devices registered with ClearPass Policy Manager will be discovered by Bonjour devices, based on the ClearPass Policy Manager policy.

In the CLI

To configure AirGroup:

```
(Instant AP) (config)# airgroup
(Instant AP) (airgroup)# enable [dlna-only| mdns-only]
(Instant AP) (airgroup)# cppm enforce-registration
(Instant AP) (airgroup)# cppm-server <server>
(Instant AP) (airgroup)# cppm-query-interval <interval>
(Instant AP) (airgroup)# disallow-vlan <vlan-ID>
(Instant AP) (airgroup)# enable-guest-multicast
(Instant AP) (airgroup)# multi-swarm
(Instant AP) (airgroup)# end
(Instant AP)# commit apply
```

To enable DLNA support:

```
(Instant AP) (config)# airgroup
(Instant AP) (airgroup)# enable dlna-only
(Instant AP) (airgroup)# end
(Instant AP)# commit apply
```

To enable support for Bonjour services:

```
(Instant AP) (config)# airgroup
(Instant AP) (config)# enable mdns-only
(Instant AP) (airgroup)# end
(Instant AP)# commit apply
```

To configure AirGroup Service

```
(Instant AP) (config)# airgroupservice <airgroup-service>
(Instant AP) (airgroup-service)# id <airgroupservice-ID>
(Instant AP) (airgroup-service)# description <text>
(Instant AP) (airgroup-service)# disallow-role <role>
(Instant AP) (airgroup-service)# disallow-vlan <vlan-ID>
(Instant AP) (airgroup-service)# end
```

```
(Instant AP)# commit apply
```

To verify the AirGroup configuration status:

```
(Instant AP)# show airgroup status
```

Configuring AirGroup and ClearPass Policy Manager interface in AOS-W Instant

Configure the AOS-W Instant and ClearPass Policy Manager interface to allow an AirGroup OAW-IAP and ClearPass Policy Manager to exchange information regarding device sharing, and location. The configuration options define the RADIUS server that is used by the AirGroup RADIUS client.

The AirGroup configuration with ClearPass Policy Manager involves the following steps:

1. [Create a RADIUS service](#)
2. [Assign a Server to AirGroup](#)
3. [Configure ClearPass Policy Manager to Enforce Registration](#)

Creating a RADIUS Server

You can configure an external RADIUS Security window. For more information on the configuring ClearPass Policy Manager server, see [Configuring an External Server for Authentication on page 163](#). You can also create a RADIUS server in the **Air Group** window. Navigate to **Services > AirGroup > Clear Pass Settings > CPPM server 1 >** and select **New** from the drop-down list.

Assign a Server to AirGroup

To associate the ClearPass Policy Manager server with AirGroup, select the ClearPass Policy Manager server from the **CPPM Server 1** drop-down list.



If two ClearPass Policy Manager servers are configured, the CPPM server 1 acts as a primary server and the CPPM server 2 acts as a backup server.

After the configuration is complete, this particular server will be displayed in the CoA server option. To view this server go to **Services > AirGroup > ClearPass Settings > CoA server**.

Configure ClearPass Policy Manager to Enforce Registration

When ClearPass Policy Manager registration is enforced, the devices registered with ClearPass Policy Manager will be discovered by Bonjour devices, based on the ClearPass Policy Manager policy.

Change of Authorization (CoA)

When a RADIUS server is configured with Change of Authorization (CoA) with the ClearPass Policy Manager server, the guest users are allowed to register their devices. For more information on configuring RADIUS server with CoA, see [Configuring an External Server for Authentication on page 163](#).



You can also create a **CoA only server** in the **Services > AirGroup > Clear Pass Settings > CoA server** window.

Configuring an OAW-IAP for RTLS Support

AOS-W Instant supports the real-time tracking of devices when integrated with the OmniVista, or a third-party Real Time Location Server such as Aeroscout Real Time Location Server. With the help of the RTLS, the devices can be monitored in real-time or through history.

You can configure RTLS using the AOS-W Instant UI or CLI.

In the AOS-W Instant UI

To configure Aruba RTLS:

1. Click the **More > Services** link at the top right corner of the AOS-W Instant main window. The **Services** window is displayed.
2. Click the **RTLS** tab. The following figure shows the contents of the **RTLS** tab.
3. Under **Aruba**, select the **RTLS** check-box to integrate AOS-W Instant with the OmniVista or Ekahau Real Time Location Server.

Figure 77 RTLS Window

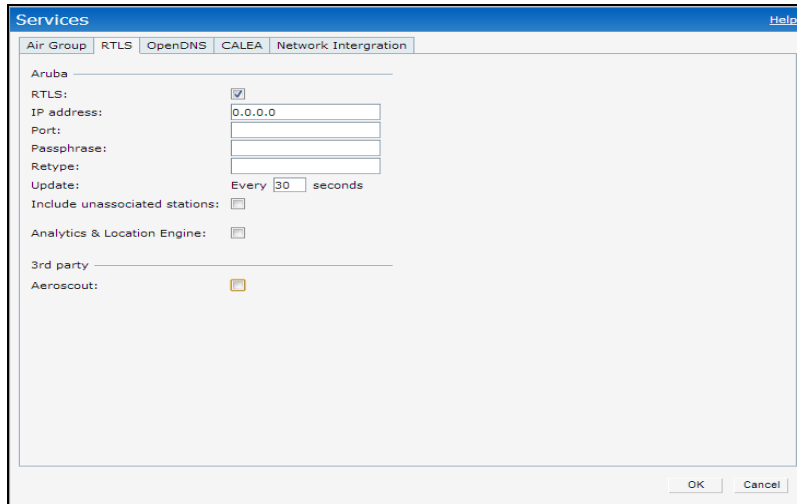

4. Specify the IP address and port to which the location reports must be sent.
5. Specify the shared secret key in the **Passphrase** text box.
6. Specify the frequency at which the Virtual Controller can send updates to the server. You can specify a value within the range of 5-3600 seconds. The default value is 5 seconds.
7. Select the **Include unassociated stations** check-box to send reports on the stations that are not associated to any OAW-IAP to the RTLS server.
8. Click **OK**.

To configure third-party RTLS such as Aeroscout:

1. Select the **Aeroscout** check-box to send the RFID tag information to an AeroScout RTLS.
2. Specify the IP address and port number of the AeroScout server, to which location reports must be sent.
3. Select the **Include unassociated stations** check-box to send reports on the stations that are not associated to any OAW-IAP to the Aeroscout RTLS server.
4. Click **OK**.

In the CLI

To configure OmniVista RTLS:

```
(Instant AP) (config)# airwave-rtls <IP-address> <port> <passphrase> <seconds> include-unassoc-sta
(Instant AP) (config)# end
(Instant AP)# commit apply
```

To configure Aeroscout RTLS

```
(Instant AP) (config)# aeroscout-rtls <IP-address> <port> include-unassoc-sta
(Instant AP) (config)# end
(Instant AP)# commit apply
```

Configuring an OAW-IAP for Analytics and Location Engine Support

The Analytics and Location Engine (ALE) is designed to gather client information from the network, process it and share it through a standard API. The client information gathered by ALE can be used for analyzing a client's internet behavior for business such as shopping preferences.

ALE includes a location engine that calculates the associated and unassociated device location every 30 seconds by default. For every device on the network, ALE provides the following information through the Northbound API:

- Client user name
- IP address
- MAC address
- Device type
- Application firewall data, showing the destinations and applications used by associated devices.
- Current location
- Historical location

ALE requires the AP placement data to be able to calculate location for the devices in a network.

ALE with AOS-W Instant

The AOS-W Instant 6.3.1.1-4.0 release supports Analytics and Location Engine (ALE). The ALE server acts as a primary interface to all third-party applications and the OAW-IAP sends client information and all status information to the ALE server.

To integrate OAW-IAP with ALE, the ALE server address must be configured on an OAW-IAP. If the ALE sever is configured with a host name, the Virtual Controller performs a mutual certificated-based authentication with ALE server, before sending any information.

Enabling ALE Support on an OAW-IAP

You can configure an OAW-IAP for ALE support using the AOS-W Instant UI or CLI.

In the AOS-W Instant UI

1. Click **More > Services**. The **Services** window is displayed.
2. Click the **RTLS** tab. The tab details are displayed.
3. Select the **Analytics & Location Engine** checkbox.

Figure 78 Services Window —ALE Integration

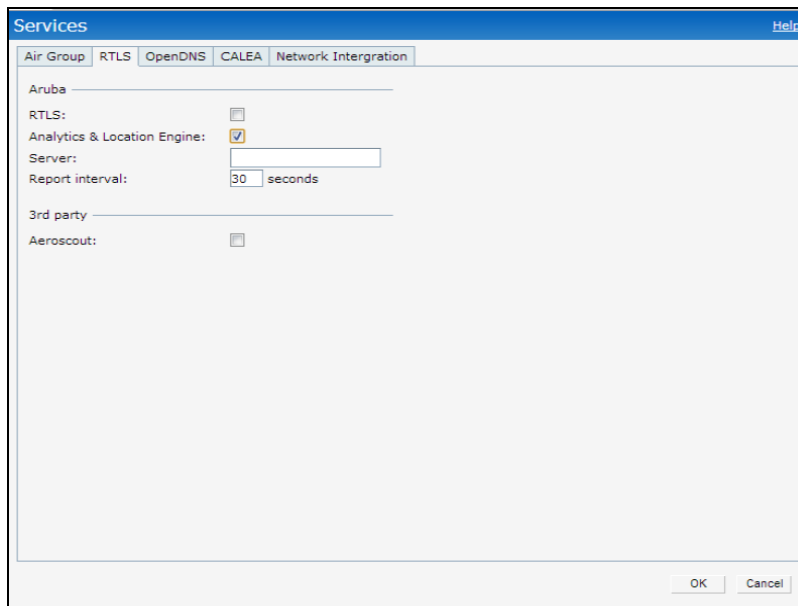

4. Specify the ALE server name or IP address.
5. Specify the reporting interval within the range of 6–60 seconds. The OAW-IAP sends messages to the ALE server at the specified interval. The default interval is 30 seconds.
6. Click **OK**.

In the CLI

To enable OAW-IAP integration with the ALE server:

```
(Instant AP) (config) # ale-server <server-name| IP-address>
(Instant AP) (config) # ale-report-interval <seconds>
(Instant AP) (config) # end
(Instant AP) # commit apply
```

Verifying ALE Configuration on an OAW-IAP

To view the configuration details:

```
(Instant AP) # show ale config
```

To verify the configuration status

```
(Instant AP) # show ale status
```

Managing BLE Beacons

In AOS-W Instant 6.4.3.4-4.2.1.0, OAW-IAPs support Alcatel-Lucent Bluetooth Low Energy (BLE) devices, such as BT-100 and BT-105, which are used for location tracking and proximity detection. The BLE devices can be connected to an OAW-IAP and are monitored or managed by a cloud based Beacon Management Console (BMC). The BLE beacon management feature allows you to configure parameters for managing the BLE beacons and establishing secure communication with the Beacon Management Console (BMC). You can also configure the BLE operation modes that determine the functions of the built-in BLE chip in the OAW-IAP.



The BLE beacon management and BLE operation mode feature is supported only on IAP-324/325, OAW-IAP214/215, OAW-IAP224/225, and OAW-IAP205H devices.

You can configure BLE operation modes and enable the BLE beacon management feature using the AOS-W Instant UI or CLI.

In the AOS-W Instant UI

1. Click **More > Services**. The **Services** window is displayed.
2. Click the **RTLS** tab. The tab details are displayed.
3. To manage the BLE devices using BMC, select **Manage BLE Beacons**.
4. Enter the authorization token. The authorization token is a text string of 1-255 characters used by the BLE devices in the HTTPS header when communicating with the BMC. This token is unique for each deployment.
5. In **Endpoint URL**, enter the URL of the server to which the BLE sends monitoring data.
6. Select any of the following options from **Operation Mode** drop-down list:

Table 60: BLE Operation Modes

Mode	Description
Beaconing	The built-in BLE chip of the OAW-IAP functions as an iBeacon combined with the beacon management functionality.
Disabled	The built-in BLE chip of the OAW-IAP is turned off. BLE operation mode is set the Disabled by default.
DynamicConsole	The built-in BLE chip of the OAW-IAP functions in the beaconing mode and dynamically enables access to OAW-IAP console over BLE when the link to the Local Management Switch (LMS) is lost.
PersistentConsole	The built-in BLE chip of the OAW-IAP provides access to the OAW-IAP console over BLE and also operates in the Beaconing mode.

7. Click **OK**.

In the CLI

To enable BLE beacon management:

```
(host) (config) # ble config <token> <url>
(host) (config) # end
(host) # commit apply
```

To configure a BLE operation mode:

```
(host) (config) # ble mode <opmode>
(host) (config) # end
(host) # commit apply
```

To view the BLE configuration details:

```
(host) # show ble-config
```

Configuring OpenDNS Credentials

When configured, the OpenDNS credentials are used by AOS-W Instant to access OpenDNS to provide enterprise-level content filtering. You can configure OpenDNS credentials using the AOS-W Instant UI or CLI.

In the AOS-W Instant UI

To configure OpenDNS credentials:

1. Click **More > Services > OpenDNS**. The **OpenDNS** tab contents are displayed.

2. Enter the **Username** and **Password** to enable access to OpenDNS.
3. Click **OK** to apply the changes.

In the CLI

To configure OpenDNS credentials:

```
(Instant AP) (config)#.opendns <username <password>
(Instant AP) (config)# end
(Instant AP)# commit apply
```

Integrating an OAW-IAP with Palo Alto Networks Firewall

Palo Alto Networks (PAN) next-generation firewall offers contextual security for all users for safe enabling of applications. A simple firewall beyond basic IP address or TCP port numbers only provides a subset of the enhanced security required for enterprises to secure their networks. In the context of businesses using social networking sites, legacy firewalls are not able to differentiate valid authorized users from casual social networking users.

The Palo Alto next-generation firewall is based on user ID, which provides many methods for connecting to sources of identity information and associating them with firewall policy rules. For example, it provides an option to gather user information from Active Directory or LDAP server.

Integration with AOS-W Instant

The functionality provided by the PAN firewall based on user ID requires the collection of information from the network. OAW-IAP maintains the network (such as mapping IP address) and user information for its clients in the network and can provide the required information for the user ID feature on PAN firewall. Before sending the user-ID mapping information to the PAN firewall, the OAW-IAP must retrieve an API key that will be used for authentication for all APIs.

OAW-IAP provides the User ID mapping information to the PAN firewall for integration. The client user id for authentication will not be sent to the PAN firewall unless it has a domain prefix. The OAW-IAP checks for the domain information in the client username for all login and logout requests sent to the PAN firewall. If the user id already has a domain prefix, OAW-IAP forwards the request to the PAN firewall. Otherwise, the static client domain configured in the PAN firewall profile will be prefixed to the user id and then sent to the PAN firewall.

OAW-IAP and PAN firewall integration can be seamless with the XML-API that available with PAN-OS 5.0 or later.

To integrate an OAW-IAP with PAN user ID, a global profile is added. This profile can be configured on an OAW-IAP with PAN firewall information such as IP address, port, user name, password, firewall enabled or disabled status.

The OAW-IAP sends messages to PAN based on the type of authentication and client status:

- After a client completes the authentication and is assigned an ip address, OAW-IAP will send the **login** message.
- After a client is disconnected or dissociated from the OAW-IAP, the OAW-IAP sends a **logout** message.

Configuring an OAW-IAP for PAN integration

You can configure an OAW-IAP for PAN firewall integration using the AOS-W Instant UI or CLI.

In the AOS-W Instant UI

1. Click **More > Services**. The **Services** window is displayed.
2. Click **Network Integration**. The PAN firewall configuration options are displayed.

Figure 79 Services Window - Network Integration Tab

The screenshot shows the 'Services' window with the 'Network Integration' tab selected. The 'Palo Alto Network firewall integration' section includes a checkbox for 'Enable', and text boxes for 'Username', 'Password', 'Retype', 'IP address', 'Port' (set to 443), and 'Client domain'. The 'XML API Server Configuration' section features a list box titled 'XML API Servers' containing 'test' and 'test1', with 'test' highlighted. Below the list are 'New', 'Edit', and 'Delete' buttons. The window has a blue title bar with 'Services' and 'Help' text, and 'OK' and 'Cancel' buttons at the bottom right.

3. Select the **Enable** checkbox to enable PAN firewall.
4. Specify the **Username** and **Password**. Ensure that you provide user credentials of the PAN firewall administrator.
5. Enter the PAN firewall IP address.
6. Enter the port number within the range of 1—65535. The default port is 443.
7. Specify the static **Client Domain** to be mapped to the client User IDs that do not have a domain name of its own.
8. Click **OK**.

In the CLI

To enable PAN firewall integration with the OAW-IAP:

```
(Instant AP) (config)# firewall-external-enforcement pan
(Instant AP) (firewall-external-enforcement pan)# enable
(Instant AP) (firewall-external-enforcement pan)# domain-name <name>
(Instant AP) (firewall-external-enforcement pan)# ip <ip-address>
(Instant AP) (firewall-external-enforcement pan)# port <port>
(Instant AP) (firewall-external-enforcement pan)# user <name> <password>
(Instant AP) (firewall-external-enforcement pan)# end
(Instant AP) # commit apply
```

Integrating an OAW-IAP with an XML API interface

The XML API interface provides options to create and execute user management operations seamlessly on behalf of the clients or users.

Integration with AOS-W Instant

The XML API interface allows you to send specific XML commands to an OAW-IAP from an external server. These XML commands can be used to customize OAW-IAP client entries. You can use the XML API interface to add, delete, authenticate, query, or blacklist a user or a client.

The user authentication is supported only for users authenticated by captive portal authentication and not for the dot1x-authentication users.



The user add operation performed by the XML API interface is only used to modify the role of an existing user and not to create a new user.

You can now use HTTP or HTTPS to post commands to OAW-IAP. The communication process using the XML API Interface is as follows:

- An API command is issued in XML format from the server to the Virtual Controller.
- The Virtual Controller processes the XML request and identifies where the client is and sends the command to the correct slave OAW-IAP.
- Once the operation is completed, Virtual Controller sends the XML response to the XML server.
- Users can use the response and take appropriate action to suit their requirements. The response from the Virtual Controller is returned using the predefined formats.

Configuring an OAW-IAP for XML API integration

You can configure an OAW-IAP for XML API integration using the AOS-W Instant UI or CLI. OAW-IAP supports the configuration of up to 8 XML API server entries.

In the AOS-W Instant UI

1. Click **More > Services**. The **Services** window is displayed.
2. Click **Network Integration**. The XML API Server configuration parameters are displayed.
3. Enter a **Name** for the XML API Server.
4. Enter the **Subnet** of the XML API Server.
5. Enter the **Mask** of the XML API Server.
6. Enter a **Passphrase** to enable an authorized access to the XML API Server.
7. Re-enter the **Passphrase** in the **Retype** box.
8. To add multiple entries, repeat the procedure.
9. Click **OK**.
10. To edit or delete the server entries, use the **Edit** and **Delete** buttons respectively.

In the CLI

To enable XML API integration with the OAW-IAP:

```
(Instant AP) (config)# xml-api-server <xml_api_server_profile>
(Instant AP) (xml-api-server <profile-name>)# ip <subnet> [mask <mask>]
(Instant AP) (xml-api-server)# key <key>
(Instant AP) (xml-api-server)# end
(Instant AP)# commit apply
```

Creating an XML API Request

You can now create an XML request with an appropriate authentication command and send it to the virtual controller via HTTPS post. The format of the URL to send the XML request is:

```
https://<virtualcontroller-ip>/auth/command.xml
```

- **virtualcontroller-ip**: The IP address of the virtual controller that will receive the XML API request
- **command.xml** : The XML request that contains the XML API command.

The format of the XML API request is:

```
xml=<aruba command="<XML API command">
<options>Value</options>
...
<options>Value</options>
</aruba>
```

You can specify any of the following commands in the XML request:

Table 61: XML API Command

Parameter	Description
user_add	If the user entry is already present in the user table, the command will modify the entry with the values defined in the XML request. For an existing user, this command will update any value that is supplied, with an exception of IP and MAC address. Session time-out is only applicable to captive portal users.
user_delete	This command deletes an existing user from the virtual controller's user table. NOTE: Do not use the user_delete command if the intention is to clear the association from the virtual controller user table. If the client is dual-stack, it re-inherits the authentication state from the IPv6 address. If not dualstack, the client reverts to the initial role.
user_authenticate	This command authenticates against the server group defined in the captive portal profile. This is only applicable to captive portal users.
user_blacklist	This command blacklists a user from connecting to your network. This command uses the default blacklist timeout of 3600 seconds. There is no corresponding clear command.
user_query	This command fetches the status and details of a user connected to your network. A dual-stack client can be queried by any of its IPv4 or IPv6 addresses, but only the queried IP address is displayed in the output.

Each XML API command requires certain mandatory options to successfully execute the task. The list of all available options are:

Table 62: XML API Command Options

Parameter	Description	Range / Defaults
ipaddr	IP address of the user in IPv4 or IPv6 format.	—
macaddr	MAC address of the user in aa:bb:cc:dd:ee:ff format.	Enter MAC address with colon.
user	Name of the user.	64 character string

Parameter	Description	Range / Defaults
role	This option is used to change the role of an existing user. This option applies to user_add and user_delete commands only.	64 character string
password	The password of the user for authentication.	—
session_timeout	The role will be changed to a pre-auto role after session timeout.	—
authentication	Authentication method used to authenticate the message and the sender. You can use any of MD5, SHA-1 or clear text methods of authentication. This option is ignored if shared secret is not configured. It is, however, mandatory if it is configured.	
key	This is the encoded SHA1/MD5 hash of shared secret or plaintext shared secret. This option is ignored if shared secret is not configured on the switch. The actual MD5/SHA-1 hash is 16/20 bytes and consists of binary data. It must be encoded as an ASCII based HEX string before sending. It must be present when the virtual controller is configured with an xml-api key for the server. Encoded hash length is 32/40 bytes for MD5/SHA-1.	
version	The version of the XML API interface available in the virtual controller. This field is mandatory in all XML API requests.	Current version 1.0

CALEA Integration and Lawful Intercept Compliance

Lawful Intercept (LI) allows the Law Enforcement Agencies (LEA) to perform an authorized electronic surveillance. Depending on the country of operation, the service providers (SPs) are required to support LI in their respective networks.

In the United States, SPs are required to ensure LI compliance based on Communications Assistance for Law Enforcement Act (CALEA) specifications.

AOS-W Instant supports CALEA integration in a hierarchical and flat topology, mesh OAW-IAP network, the wired and wireless networks.



Enable this feature only if lawful interception is authorized by a law enforcement agency.

CALEA Server Integration

To support CALEA integration and ensure LI compliance, you can configure the OAW-IAPs to replicate a specific or selected client traffic and send it to a remote CALEA server.

Traffic Flow from OAW-IAP to CALEA Server

You can configure an OAW-IAP to send GRE encapsulated packets to the CALEA server and replicate client traffic within the GRE tunnel. Each OAW-IAP sends GRE encapsulated packets only for its associated or connected clients. The following figure illustrates the traffic flow from the OAW-IAP to the CALEA server.

Figure 80 IAP to CALEA Server

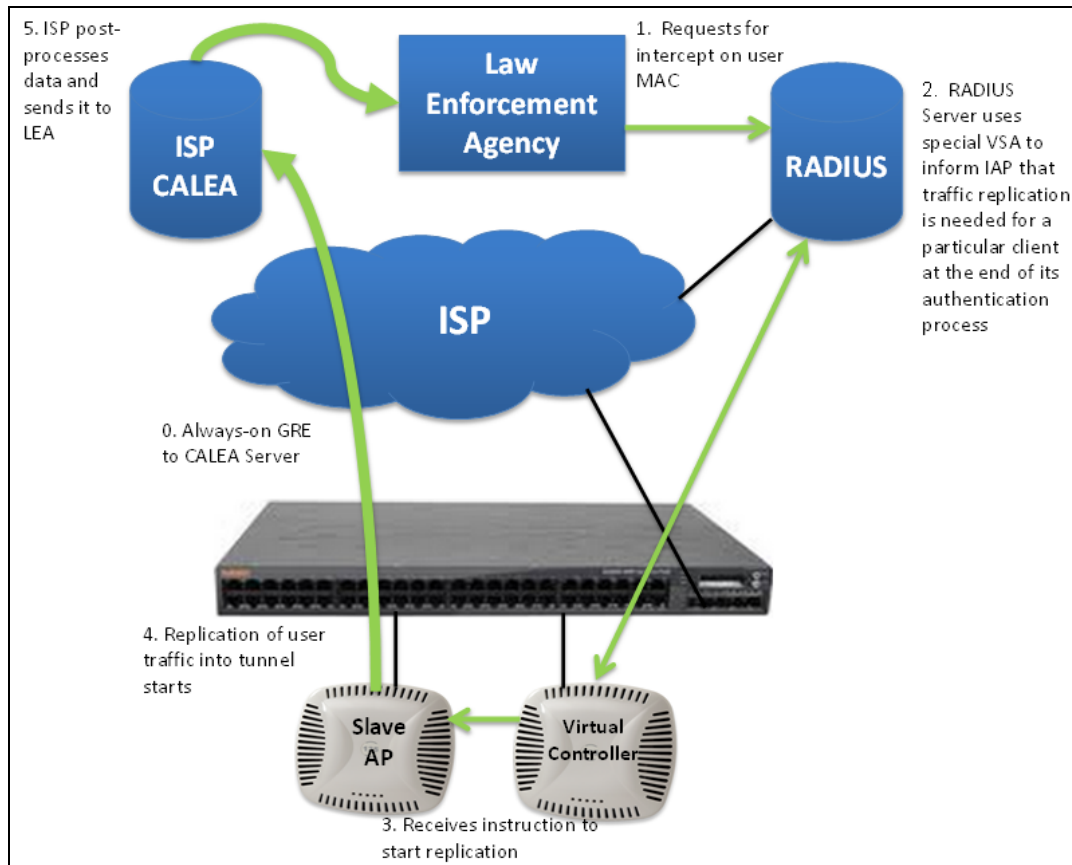

Traffic Flow from OAW-IAP to CALEA Server through VPN

You can also deploy the CALEA server with the switch and configure an additional IPsec tunnel for corporate access. When CALEA server is configured with the switch, the client traffic is replicated by the slave OAW-IAP and client data is encapsulated by GRE on slave, and routed to the master OAW-IAP. The master OAW-IAP sends the IPsec client traffic to the switch. The switch handles the IPsec client traffic while GRE data is routed to the CALEA server. The following figure illustrates the traffic flow from OAW-IAP to the CALEA server through VPN.

Figure 81 OAW-IAP to CALEA Server through VPN

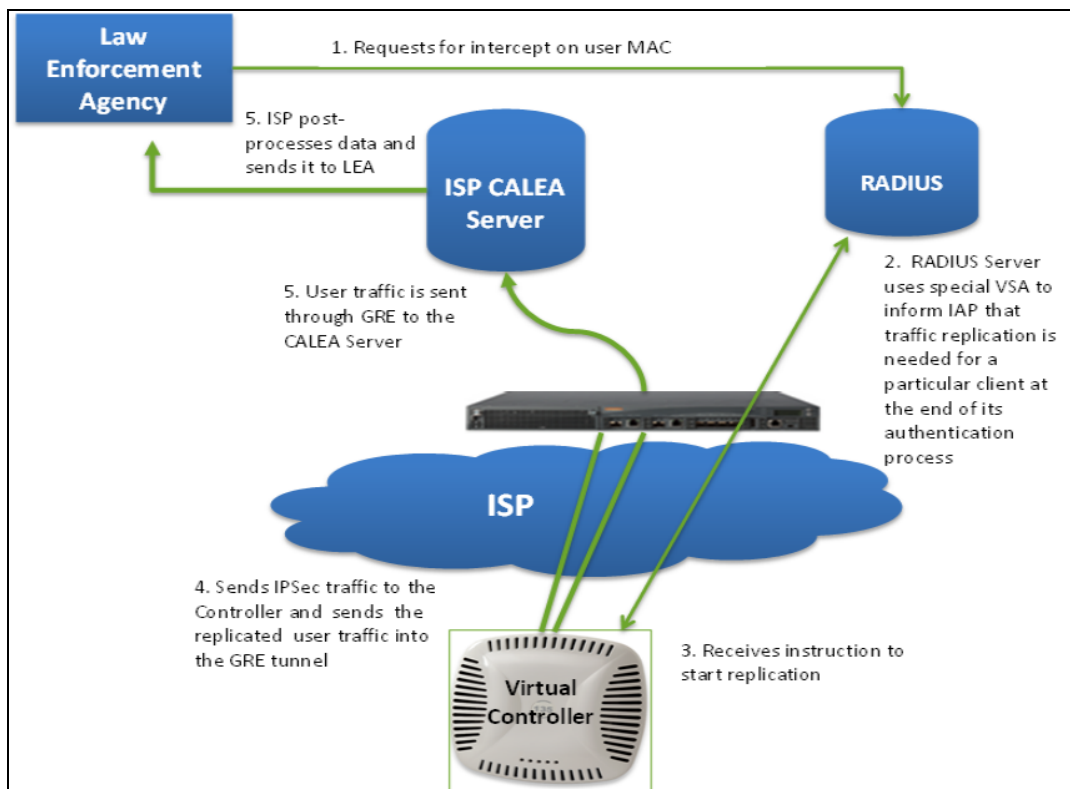

Ensure that IPsec tunnel is configured if the client data has to be routed to the ISP or CALEA server through VPN. For more information on configuring IPsec, see [Configuring an IPsec Tunnel on page 234](#).

Client Traffic Replication

Client traffic is replicated in the following ways:

- Through RADIUS VSA— In this method, the client traffic is replicated by using the RADIUS VSA to assign clients to a CALEA related user role. To enable role assignment to clients, you need to create a user role and a CALEA access rule, and then assign the CALEA rule to the user role. Whenever a client that is configured to use a CALEA rule connects, a replication role is assigned.
- Through Change of Authorization (CoA)—In this method, a user session can start without replication. When the network administrator triggers a CoA from the RADIUS server, the user session is replicated. The replication is stopped when the user disconnects or by sending a CoA to change the replication role.

As the client information is shared between multiple OAW-IAPs in a cluster, the replication rules persist when clients roam within the cluster.

Configuring an OAW-IAP for CALEA Integration

To enable CALEA server integration, perform the following steps:

1. [Create a CALEA profile](#).
2. If a replication role must be assigned through the RADIUS VSA, [create an access rule and assign the access rule to a WLAN SSID or wired profile](#).
3. [Verify the configuration](#).

Creating a CALEA Profile

You can create a CALEA profile by using the AOS-W Instant UI or CLI.

In the AOS-W Instant UI

To configure a CALEA profile:

1. Click **More** > **Services** at the top right corner of the AOS-W Instant main window.
2. Click **CALEA**. The **CALEA** tab details are displayed.
3. Specify the following parameters:
 - **IP address**— Specify the IP address of the CALEA server.
 - **Encapsulation type**— Specify the encapsulation type. The current release of AOS-W Instant supports GRE only.
 - **GRE type**— Specify the GRE type.
 - **MTU**— Specify a size for the maximum transmission unit (MTU) within the range of 68—1500. After GRE encapsulation, if packet length exceeds the configured MTU, IP fragmentation occurs. The default MTU size is 1500.
4. Click **OK**.

In the CLI

```
(Instant AP) (config)# calea
(Instant AP) (calea)# ip <IP-address>
(Instant AP) (calea)# ip mtu <size>
(Instant AP) (calea)# encapsulation-type <gre>
(Instant AP) (calea)# gre-type <type>
(Instant AP) (calea)# end
(Instant AP)# commit apply
```

Creating an Access Rule for CALEA

You can create an access rule for CALEA by using the AOS-W Instant UI or CLI.

In the AOS-W Instant UI

To create an access rule:

1. To add the CALEA access rule to an existing profile, select an existing wireless (**Networks** tab > **edit**) or wired (**More** > **Wired** > **Edit**) profile. To add the access rule to a new profile, click **New** under Network tab and create a WLAN profile, or click **More**>**Wired**>**New** and create a wired port profile.
2. On the **Access** tab, select the role for which you want create the access rule.
3. Under **Access Rules**, click **New**. The **New Rule** window is displayed.
4. Select **CALEA**.
5. Click **OK**.
6. Create a role assignment rule if required.
7. Click **Finish**.

In the CLI

To create a CALEA access rule:

```
(Instant AP) (config)# wlan access-rule <name>
(Instant AP) (Access Rule <name>)# calea
(Instant AP) (Access Rule <name>)# end
(Instant AP)# commit apply
```

To assign the CALEA rule to a user role:

```
(Instant AP) (config)# wlan ssid-profile <name>
(Instant AP) (SSID Profile <name>)# set-role <attribute>{=|<|=|starts-with|ends-
with|contains}<operator><role>|value-of}
(Instant AP) (SSID Profile <name>)# end
```



```
(Instant AP) (SSID Profile <name># commit apply
```

To associate the access rule with a wired profile:

```
(Instant AP) (config)# wired-port-profile <name>
(Instant AP) (Wired ap profile <name>)# access-rule-name <name>
(Instant AP) (Wired ap profile <name>)# end
(Instant AP)# commit apply
```

Verifying the configuration

To verify the CALEA configuration:

```
(Instant AP)# show calea config
```

To view the tunnel encapsulation statistics:

```
(Instant AP)# show calea statistics
```

Example

To enable CALEA integration:

```
(Instant AP) (config)# calea
(Instant AP) (calea)# ip 192.0.2.7
(Instant AP) (calea)# ip mtu 1500
(Instant AP) (calea)# encapsulation-type GRE
(Instant AP) (calea)# gre-type 255
(Instant AP) (calea)# end

(Instant AP) (config)# wlan access-rule ProfileCalea
(Instant AP) (Access Rule "ProfileCalea")# calea
(Instant AP) (Access Rule "ProfileCalea")# end
(Instant AP)# commit apply

(Instant AP) (config)# wlan ssid-profile Calea-Test
(Instant AP) (SSID Profile"Calea-Test")# enable
(Instant AP) (SSID Profile"Calea-Test")# index 0
(Instant AP) (SSID Profile"Calea-Test")# type employee
(Instant AP) (SSID Profile"Calea-Test")# essid QA-Calea-Test
(Instant AP) (SSID Profile"Calea-Test")# opmode wpa2-aes
(Instant AP) (SSID Profile"Calea-Test")# max-authentication-failures 0
(Instant AP) (SSID Profile"Calea-Test")# auth-server server1
(Instant AP) (SSID Profile"Calea-Test")# set-role Filter-Id equals 123456 calea-test
(Instant AP) (SSID Profile"Calea-Test")# rf-band 5.0
(Instant AP) (SSID Profile"Calea-Test")# captive-portal disable
(Instant AP) (SSID Profile"Calea-Test")# dtim-period 1
(Instant AP) (SSID Profile"Calea-Test")# inactivity-timeout 1000
(Instant AP) (SSID Profile"Calea-Test")# broadcast-filter none
(Instant AP) (SSID Profile"Calea-Test")# dmo-channel-utilization-threshold 90
(Instant AP) (SSID Profile"Calea-Test")# local-probe-req-thresh 0
(Instant AP) (SSID Profile"Calea-Test")# max-clients-threshold 64
(Instant AP) (SSID Profile"Calea-Test")# end
(Instant AP) (SSID Profile"Calea-Test")# commit apply
```

To verify the configuration:

```
(Instant AP)# show calea config
```

```
calea-ip :10.0.0.5
encapsulation-type :gre
gre-type :25944
ip mtu : 150
```

```
(Instant AP)# show calea statistics
```

```
Rt resolve fail : 0
Dst resolve fail: 0
Alloc failure : 0
Fragged packets : 0
Jumbo packets : 263
Total Tx fail : 0
Total Tx ok : 263
```

This chapter provides information on managing and monitoring OAW-IAPs from the server.

Managing an OAW-IAP from OmniVista

OmniVista is a powerful tool and easy-to-use network operations system that manages Alcatel-Lucent wireless, wired, and remote access networks, as well as wired and wireless infrastructures from a wide range of third-party manufacturers. With its easy-to-use interface, OmniVista provides real-time monitoring, proactive alerts, historical reporting, and fast, efficient troubleshooting. It also offers tools that manage RF coverage, strengthen wireless security, and demonstrate regulatory compliance.

The OAW-IAPs communicate with OmniVista using the HTTPS protocol. This allows an OmniVista server to be deployed in the cloud across a NAT device, such as a router. The OmniVista features available in the AOS-W Instant network are described in the following sections.

Image Management

OmniVista allows you to manage firmware updates on WLAN devices by defining a minimum acceptable firmware version for each make and model of a device. It remotely distributes the firmware image to the WLAN devices that require updates, and it schedules the firmware updates such that updating is completed without requiring you to manually monitor the devices.

The following models can be used to upgrade the firmware:

- **Automatic**— In this model, the Virtual Controller periodically checks for newer updates from a configured URL and automatically initiates upgrade of the network.
- **Manual**— In this model, the user can manually start a firmware upgrade for each Virtual Controller or set the desired firmware preference per group of devices.

Resetting an OAW-IAP

An OAW-IAP device can be reset through OmniVista in the **Managed** mode.

1. Under **Modify Devices**, choose the OAW-IAP devices you want to factory reset by selecting the check box next to it.
2. From the **Change Device Group Folder** dropdown, select **Factory Reset selected devices**.
3. Click the **Factory Reset** tab.



On resetting the OAW-IAP device from OmniVista, all the configuration values will be set to default except for the **per-ap-settings** and **VC Key** value.

OAW-IAP and Client Monitoring

OmniVista allows you to find any OAW-IAP or client on the wireless network and to see real-time monitoring views. These monitoring views can be used to aggregate critical information and high-end monitoring information.

In the OmniVista User Interface (UI), you can select either **Manage Read/Write** or **Monitor-only+Firmware Upgrades** as management modes. When the Management level is set to **Manage Read/Write**, the AOS-W Instant UI is in read-only mode. If OmniVista Management Level is set to **Monitor-only+Firmware Upgrades** mode, the AOS-W Instant UI changes to the read-write mode.

With the latest version of OmniVista, a new option in the OmniVista Management Platform (AMP) is available to put the OAW-IAP in config-only mode. In this mode, the OAW-IAP will receive the firmware upgrades and configurations, but will not send any statistics for monitoring. The load is reduced on OAW-IAP and OmniVista and assists in scaling OmniVista effectively.

Template-based Configuration

OmniVista automatically creates a configuration template based on any of the existing OAW-IAPs, and it applies that template across the network as shown in the following figure. It audits every device on an ongoing basis to ensure that configurations never vary from the enterprise policies. It alerts you whenever a violation is detected and automatically repairs the incorrectly configured devices.

Figure 82 *Template-based Configuration*

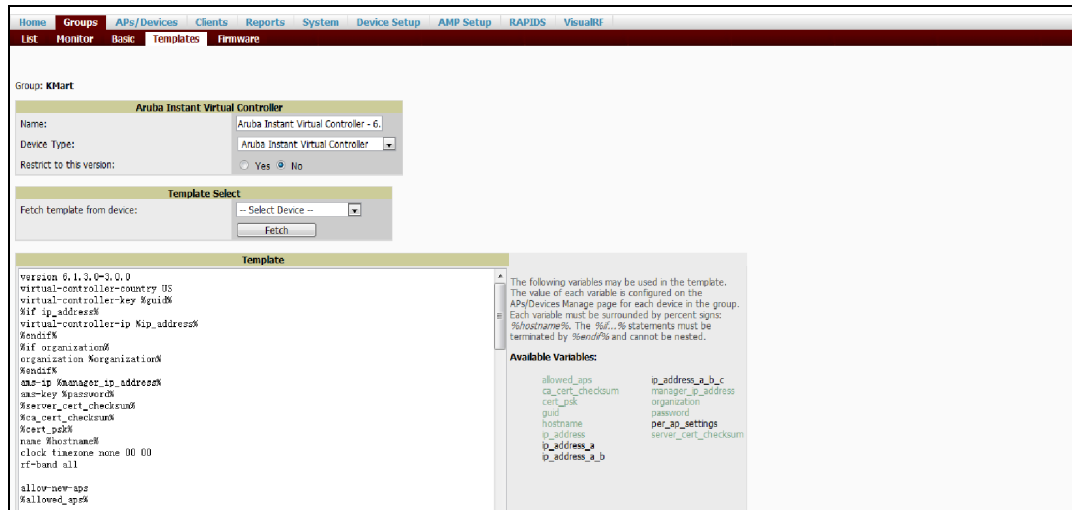

Trending Reports

OmniVista saves up to 14 months of actionable information, including network performance data and user roaming patterns, so you can analyze how network usage and performance trends have changed over time. It also provides detailed capacity reports with which you can plan the capacity and appropriate strategies for your organization.

Intrusion Detection System

OmniVista provides advanced, rules-based rogue classification. It automatically detects rogue APs irrespective of their location in the network and prevents authorized OAW-IAPs from being detected as rogue OAW-IAPs. It tracks and correlates the IDS events to provide a complete picture of network security.

Wireless Intrusion Detection System (WIDS) Event Reporting to OmniVista

OmniVista supports Wireless Intrusion Detection System (WIDS) Event Reporting, which is provided by AOS-W Instant. This includes WIDS classification integration with the RAPIDS (Rogue Access Point Detection Software) module. RAPIDS is a powerful and easy-to-use tool for automatic detection of unauthorized wireless devices. It supports multiple methods of rogue detection and uses authorized wireless APs to report other devices within range.

The WIDS report cites the number of IDS events for devices that have experienced the most instances in the prior 24 hours and provides links to support additional analysis or configuration in response.

RF Visualization Support for AOS-W Instant

OmniVista supports RF visualization for AOS-W Instant. The VisualRF module provides a real-time picture of the actual radio environment of your wireless network and the ability to plan the wireless coverage of new sites. VisualRF uses sophisticated RF fingerprinting to accurately display coverage patterns and calculate the location of every Instant device in range. VisualRF provides graphical access to floor plans, client location, and RF visualization for floors, buildings, and campuses that host your network.

Figure 83 Adding an OAW-IAP in VisualRF

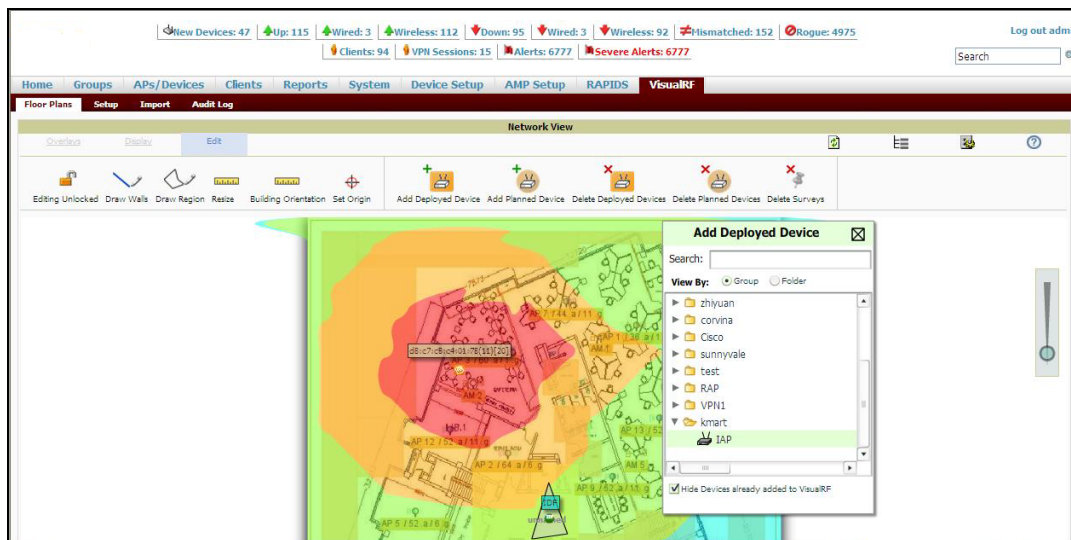

PSK-based and Certificate-based Authentication

On the DHCP server, two formats for option 43 are supported:

- **<organization>, <ams-ip>, <ams-key>**— If you choose this format, the OAW-IAP authenticates the OmniVista Management Platform server using the Pre-Shared Key (PSK) login process.
- **<organization>, <ams-domain>**— If you select this format, the OAW-IAP resolves the OmniVista domain name into one or two IP addresses as OmniVista Primary or OmniVista Backup, and then OAW-IAP starts a certificate-based authentication with OmniVista Management platform server, instead of the PSK login. When the OmniVista Management platform domain name is used, the OAW-IAP performs certificate-based authentication with the OmniVista Management platform server. The OAW-IAP initiates an SSL connection with the OmniVista server. The OmniVista server verifies the signature and public key certificate from the OAW-IAP. If the signature matches, the OmniVista responds to the OAW-IAP with the login request.

Configurable Port for OAW-IAP and OmniVista Management Server Communication

You can now customize the port number of the OmniVista management server through the **server_host:server_port** format, for example, **amp.aruba.com:4343**.

The following shows how to configure the port number of the OmniVista management server:

```
24:de:c6:cf:63:60# conf t
24:de:c6:cf:63:60 (config) # ams-ip 10.65.182.15:65535
24:de:c6:cf:63:60 (config) # end
24:de:c6:cf:63:60# commit apply
```

Configuring Organization String

The Organization string is a set of colon-separated strings created by the OmniVista administrator to accurately represent the deployment of each OAW-IAP. This string is defined by the installation personnel on the site.

You can use any of the following strings:

- AMP Role— "Org Admin" (initially disabled)
- AMP User— "Org Admin" (assigned to the role "Org Admin")
- Folder— "Org" (under the Top folder in AMP)
- Configuration Group— "Org"

You can also assign additional strings to create a hierarchy of sub folders under the folder named "Org". For example:

- subfolder1 for a folder under the "Org" folder
- subfolder2 for a folder under subfolder1

Shared Key

The Shared Secret key is an optional field used by the administrator to manually authorize the first Virtual Controller for an organization. Any string is acceptable.

Configuring OmniVista Information

You can configure OmniVista information using the AOS-W Instant UI or CLI.

In the AOS-W Instant UI

1. Click the OmniVista **Set Up Now** link in the bottom-middle region of the main window. The **System** window is displayed with the OmniVista parameters on the **Admin** tab.
2. Enter the name of your organization in the **Organization** name text box. The name defined for organization is displayed under the **Groups** tab in the OmniVista user interface.
3. Enter the IP address or domain name of the OmniVista server in the **AirWave server** text box.
4. Enter the IP address or domain name of a backup OmniVista server in the **AirWave backup server** text box. The backup server provides connectivity when the primary server is down. If the OAW-IAP cannot send data to the primary server, the Virtual Controller switches to the backup server automatically.
5. Enter the shared key in the **Shared key** text box and reconfirm. This shared key is used for configuring the first AP in the AOS-W Instant network.
6. Click **OK**.

In the CLI

To configure OmniVista information in AOS-W Instant:

```
(Instant AP) (config)# organization <name>
(Instant AP) (config)# ams-ip <IP-address or domain name>
(Instant AP) (config)# ams-backup-ip <IP-address or domain name>
(Instant AP) (config)# ams-key <key>
(Instant AP) (config)# end
(Instant AP)# commit apply
```

Example

The following example shows how to configure OmniVista information:

Configuring for OmniVista Discovery through DHCP

The OmniVista can be discovered through DHCP server. You can configure this only if OmniVista was not configured earlier or if you have deleted the precedent configuration.

On the DHCP server, the format for option 60 is “ **InstantAP**”, and the two formats for option 43 are “<organization>,<ams-ip>,<ams-key>” and “<organization>,<ams-domain>”.

If you use the <organization>,<ams-ip>,<ams-key> format, the PSK-based authentication is used to access the OmniVista Management Platform server.

If you use the <organization>,<ams-domain> format, the OAW-IAP resolves the domain name into two IP address as OmniVista Primary OmniVista Backup, and then OAW-IAP starts a certificate-based authentication with OmniVista Management platform server, instead of the PSK login.



For option 43, when you choose to enter the domain name, the IP address and key are not available.

Enabling DNS-based Discovery of the Provisioning AMP server

OAW-IAPs can now automatically discover the provisioning AMP server if the DHCP option 43 and Activate cannot perform zero-touch provisioning and transfer OmniVista configuration to the OAW-IAP.

When a domain option **xxx** is included in the DHCP configuration, the OAW-IAP will search the DNS server records for **aruba-airwave.xxx**. When there is no domain option, the OAW-IAP will only the server records for **aruba-airwave**.



To enable OAW-IAPs to automatically discover the AMP server, create a DNS record for **aruba-airwave.xxx** or **aruba-airwave** in the DNS server. To use this feature on the OmniVista side, enable certificate based login. For information on how to enable certificate based login, see [PSK-based and Certificate-based Authentication on page 309](#).

Standard DHCP option 60 and 43 on Windows Server 2008

In networks that are not using DHCP option 60 and 43, it is easy to use the standard DHCP options 60 and 43 for an AP or OAW-IAP. For APs, these options can be used to indicate the master switch or the local switch. For OAW-IAPs, these options can be used to define the OmniVista IP, group, password, and domain name.

1. From a server running Windows Server 2008 navigate to **Server Manager > Roles > DHCP sever > domain DHCP Server > IPv4**.
2. Right-click **IPv4** and select **Set Predefined Options**.

Figure 84 Instant and DHCP options for OmniVista: Set Predefined Options

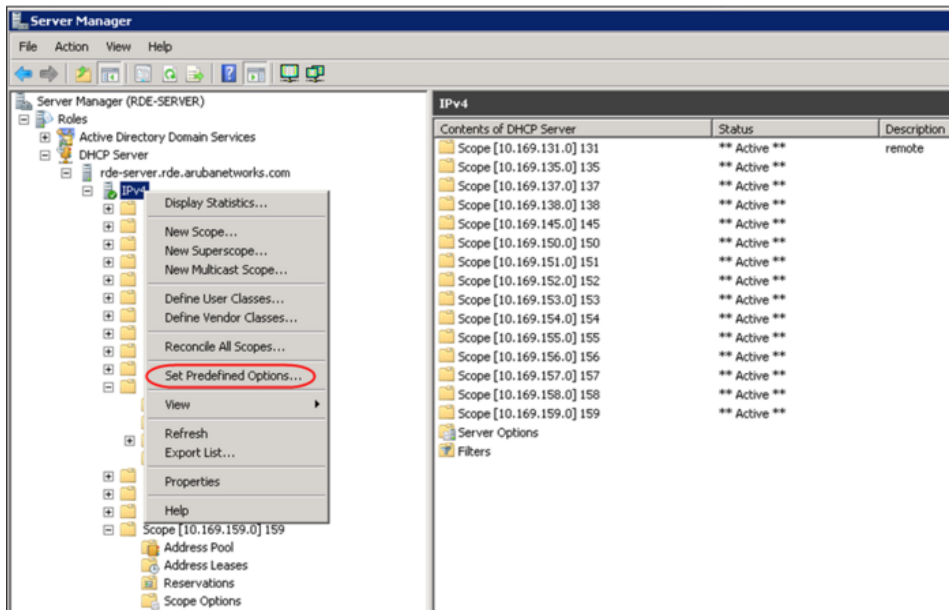

3. Select **DHCP Standard Options** in the **Option class** drop-down list and then click **Add**.
4. Enter the following information:
 - Name— AOS-W Instant
 - Data Type— String
 - Code—60
 - Description—AOS-W Instant AP

Figure 85 AOS-W Instant and DHCP options for OmniVista: Predefined Options and Values

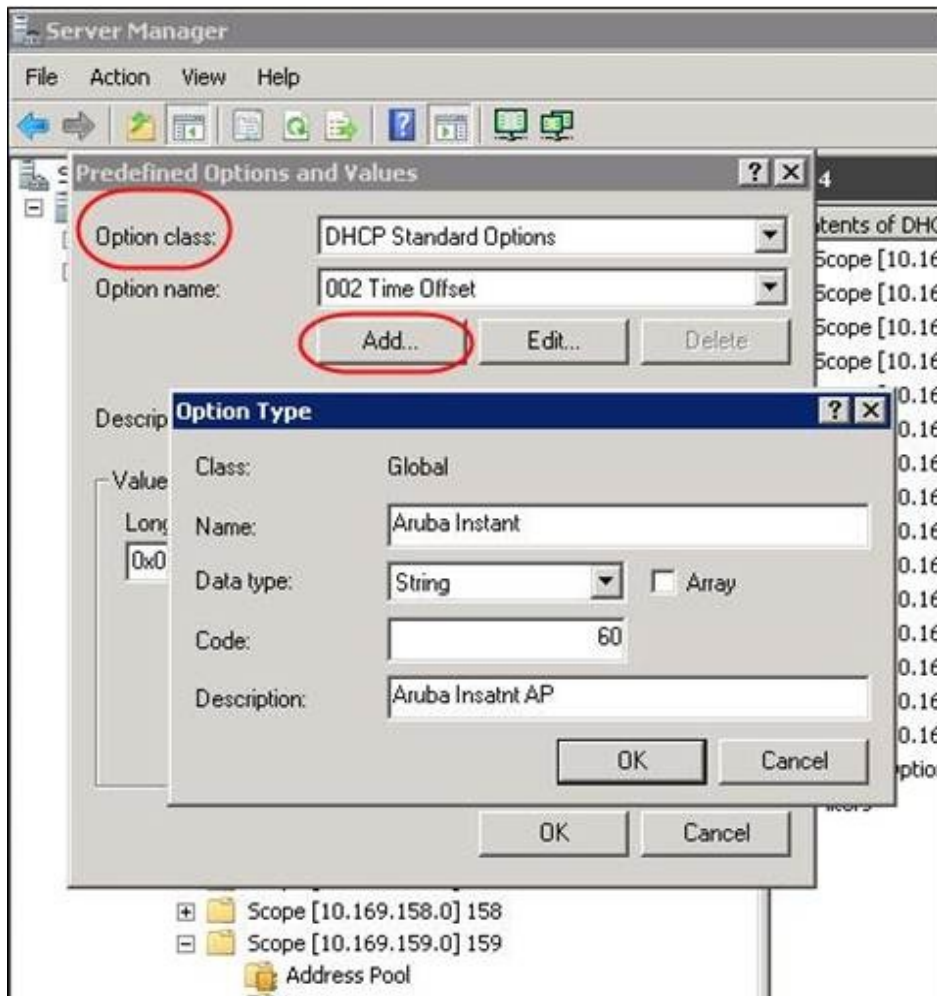

5. Navigate to **Server Manager** and select **Server Options** in the **IPv4** window. (This sets the value globally. Use options on a per-scope basis to override the global options.)
6. Right-click **Server Options** and select the configuration options.

Figure 86 AOS-W Instant and DHCP options for OmniVista: Server Options

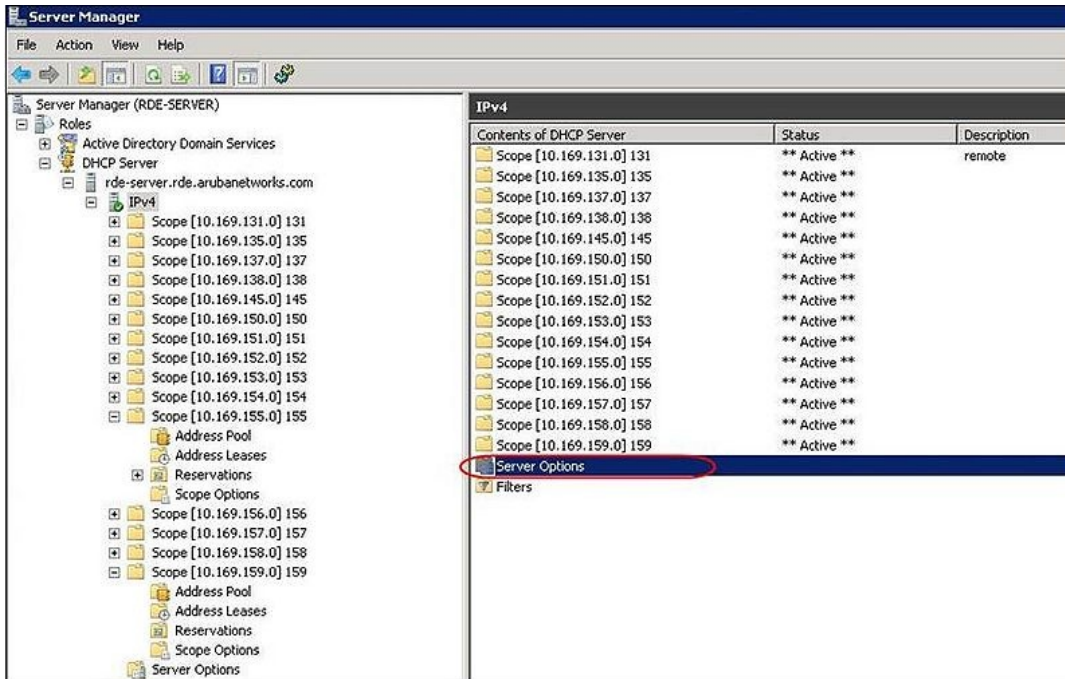

7. Select **060 Alcatel-Lucent Instant AP** in the **Server Options** window and enter **Alcatel-LucentInstantAP** in the String Value.

Figure 87 AOS-W Instant and DHCP options for OmniVista—060 OAW-IAP in Server Options

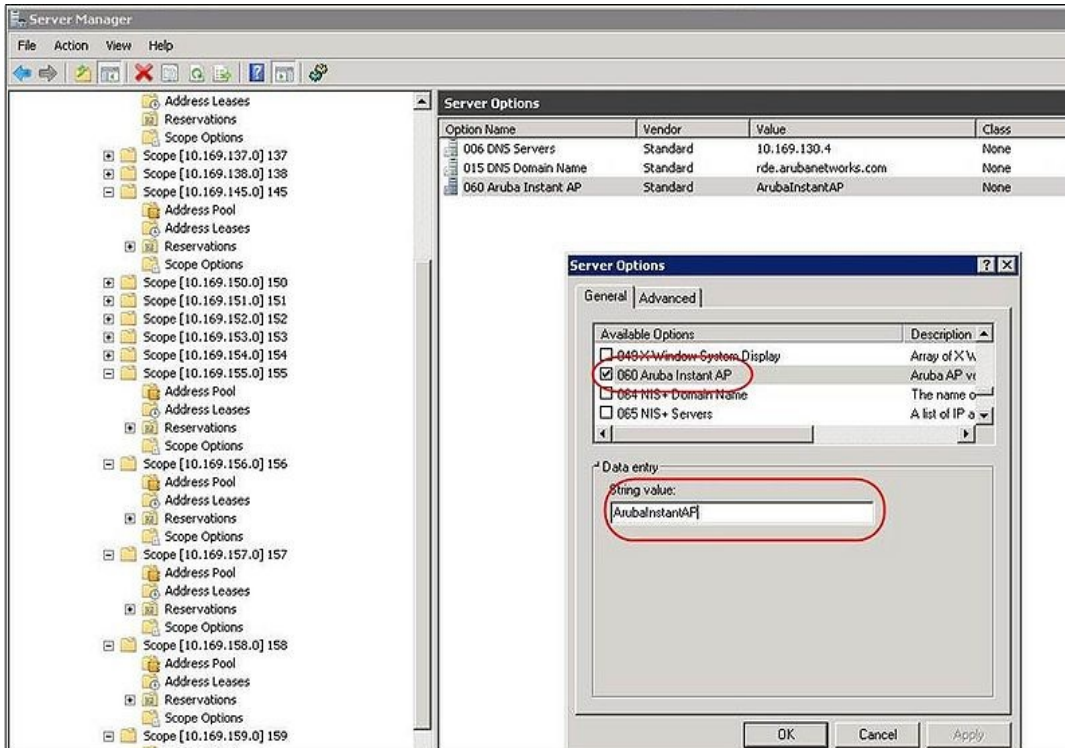

8. Select **043 Vendor Specific Info** and enter a value for either of the following in ASCII field:
- **airwave-orgn, airwave-ip, airwave-key**; for example: Alcatel-Lucent,192.0.2.20, 12344567
 - **airwave-orgn, airwave-domain**; for example: Alcatel-Lucent, alcatellucent.support.com

Figure 88 AOS-W Instant and DHCP options for—043 Vendor Specific Info

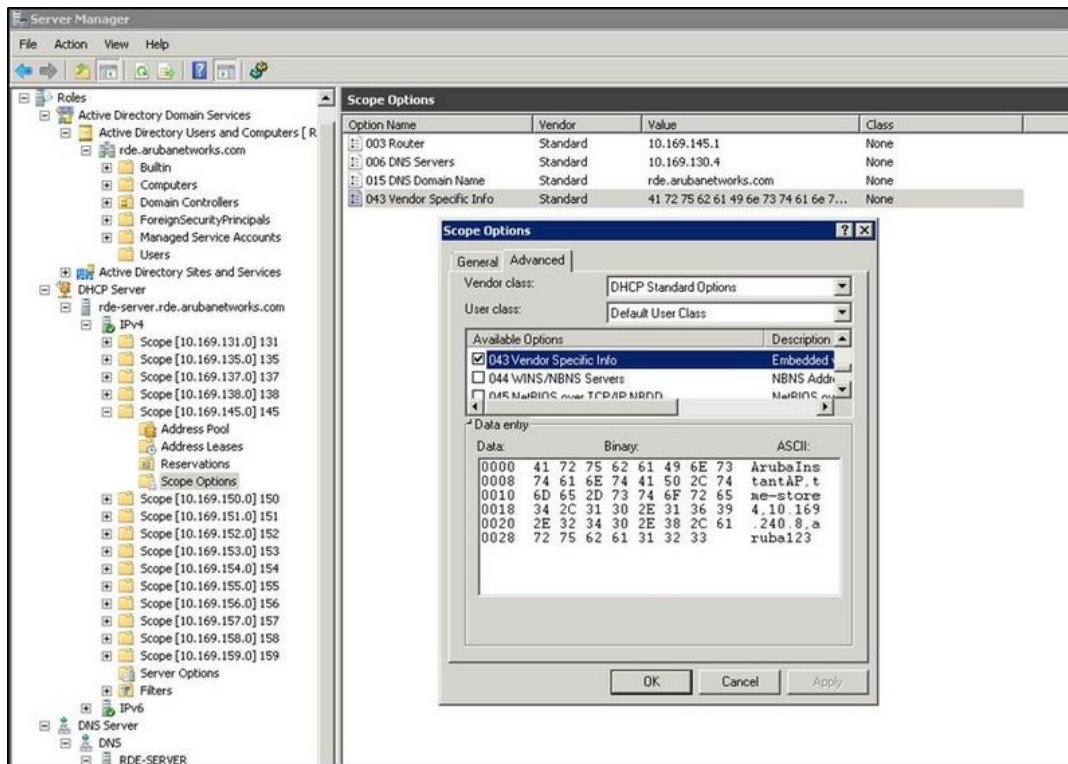

This creates a DHCP option 60 and 43 on a global basis. You can do the same on a per-scope basis. The per-scope option overrides the global option.

Figure 89 AOS-W Instant and DHCP options for OmniVista: Scope Options

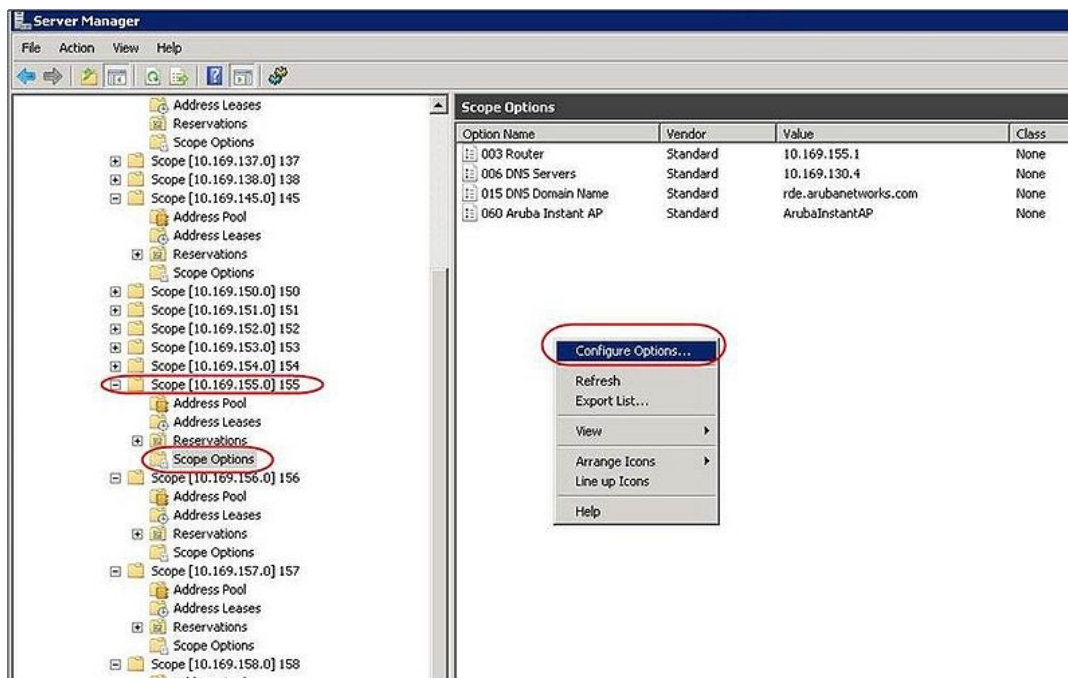

Alternate Method for Defining Vendor-Specific DHCP Options

This section describes how to add vendor-specific DHCP options for AOS-W Instant APs in a network that already uses DHCP options 60 and 43 for other services. Some networks use DHCP standard options 60 and 43 to provide the DHCP clients information about certain services such as PXE. In such an environment, the standard DHCP options 60 and 43 cannot be used for OAW-IAPs.

This method describes how to set up a DHCP server to send option 43 with OmniVista information to the OAW-IAP. This section assumes that option 43 is sent per scope, because option 60 is being shared by other devices as well.



The DHCP scope must be specific to Instant, and the PXE devices that use options 60 and 43 must not connect to the subnet defined by this scope. This is because you can specify only one option 43 for a scope, and if other devices that use option 43 connect to this subnet, they are presented with the information specific to the OAW-IAP.

1. In server 2008, navigate to **Server Manager > Roles > DHCP Server > Domain DHCP Server > IPv4**.
2. Select a scope (subnet). Scope (10.169.145.0)145 is selected in the example shown in the figure below.
3. Right-click and select **Advanced**, and then specify the following options:
 - Vendor class— DHCP Standard Options
 - User class— Default User Class
 - Available options— Select 043 Vendor-Specific Info
 - String Value— Alcatel-LucentInstantAP, tme-store4, 10.169.240.8, Alcatel-Lucent123 (which is the AP description, organization string, OmniVista IP address or domain name, Pre-shared key, for OmniVista)

Figure 90 Vendor Specific DHCP options

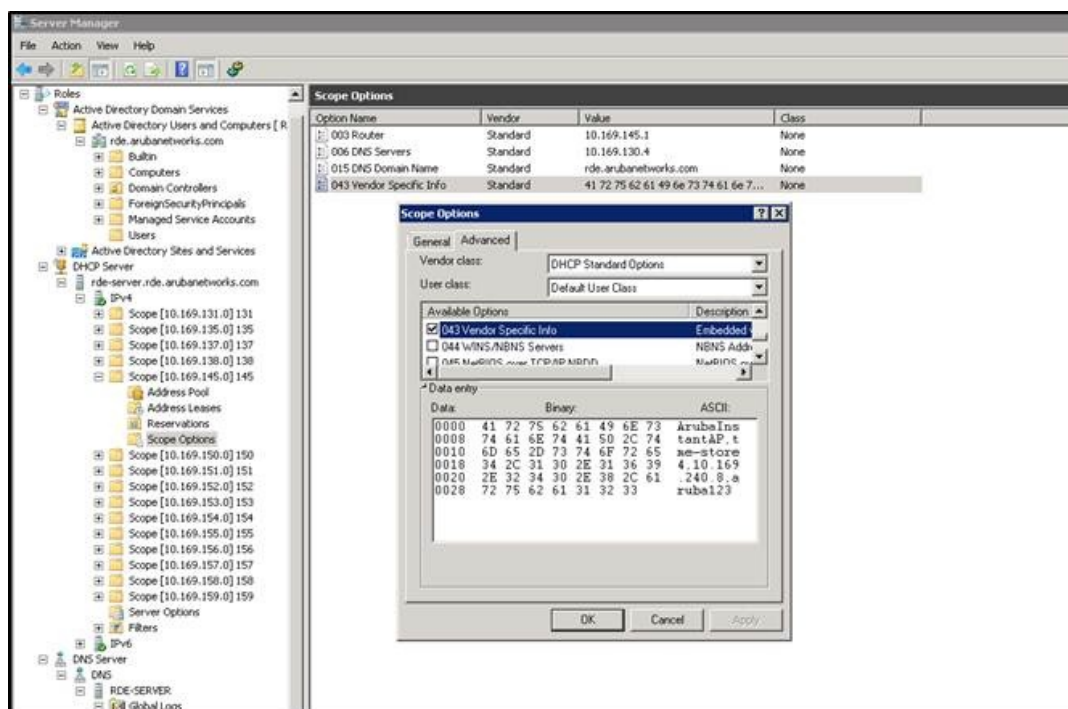

Upon completion, the OAW-IAP shows up as a new device in OmniVista, and a new group called **tme-store4** is created. Navigate to **APs/Devices > New > Group** to view this group.

Figure 91 OmniVista—New Group

Figure 92 OmniVista—Monitor

Device	Status	Detailed Status	Upstream	Upstream Status	Notes	APs	Clients	Usage	Uptime	Configuration	Folder	Controller	Location
d8:c7:c8:c4:43:19	Up	OK	-	-	-	0	0	-	4 mins	Good	.tme-store4	Instant-C4:43:19	-
Instant-C4:43:19	Up	OK	-	-	-	1	0	-	4 mins	Mismatched	.tme-store4	-	-

This chapter provides the following information:

- [Uplink Interfaces on page 318](#)
- [Ethernet Uplink on page 318](#)
- [Cellular Uplink on page 320](#)
- [Wi-Fi Uplink on page 325](#)
- [Uplink Preferences and Switching on page 326](#)

Uplink Interfaces

AOS-W Instant network supports Ethernet, 3G and 4G USB modems, and the Wi-Fi uplink to provide access to the corporate Instant network. The 3G/4G USB modems and the Wi-Fi uplink can be used to extend the connectivity to places where an Ethernet uplink cannot be configured. It also provides a reliable backup link for the Ethernet based Instant network.

The following figure illustrates a scenario in which the OAW-IAPs join the Virtual Controller as slave OAW-IAPs through a wired or mesh Wi-Fi uplink:

Figure 93 Uplink Types

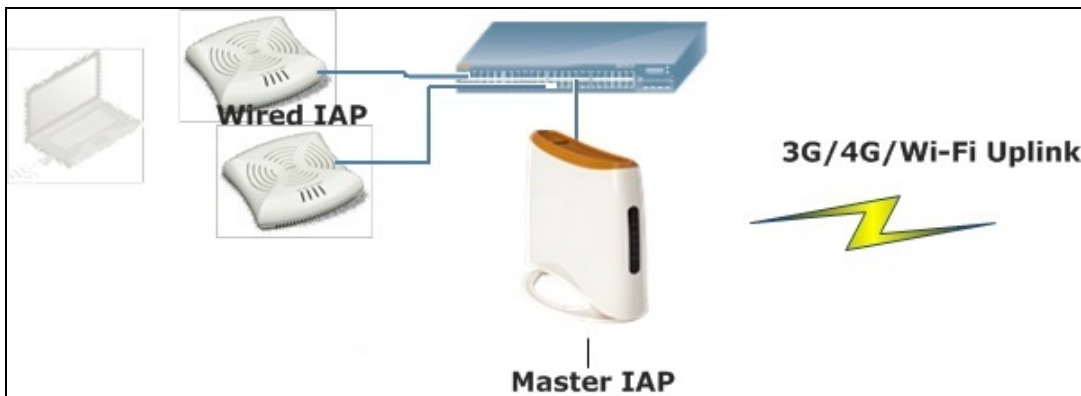

The following types of uplinks are supported on AOS-W Instant:

- [Ethernet Uplink](#)
- [Cellular Uplink](#)
- [Wi-Fi Uplink](#)

Ethernet Uplink

The Ethernet 0 port on an OAW-IAP is enabled as an uplink port by default. You can view the type of uplink and the status of the uplink in the AOS-W Instant in the **Info** tab on selecting a client.

Figure 94 Uplink Status

Info	
Name:	Instant-C4:01:78
Country code:	IN
Virtual Controller IP:	0.0.0.0
Band:	All
Master:	10.17.115.1
OpenDNS status:	Not connected
MAS integration:	Enabled
Uplink type:	Ethernet
Uplink status:	Up

Ethernet uplink supports the following types of configuration in this Instant release.

- PPPoE
- DHCP
- Static IP

You can use PPPoE for your uplink connectivity in both OAW-IAP and IAP-VPN deployments. PPPoE is supported only in a single AP deployment.



Uplink redundancy with the PPPoE link is not supported.

When the Ethernet link is up, it is used as a PPPoE or DHCP uplink. After the PPPoE settings are configured, PPPoE has the highest priority for the uplink connections. The OAW-IAP can establish a PPPoE session with a PPPoE server at the ISP and get authenticated using Password Authentication Protocol (PAP) or the Challenge Handshake Authentication Protocol (CHAP). Depending upon the request from the PPPoE server, either the PAP or the CHAP credentials are used for authentication. After configuring PPPoE, reboot the OAW-IAP for the configuration to affect. The PPPoE connection is dialed after the AP comes up. The PPPoE configuration is checked during OAW-IAP boot and if the configuration is correct, Ethernet is used for the uplink connection.



When PPPoE is used, do not configure Dynamic RADIUS Proxy and IP address of the Virtual Controller. An SSID created with default VLAN is not supported with PPPoE uplink.

You can also configure an alternate Ethernet uplink to enable uplink failover when an Ethernet port fails.

Configuring PPPoE Uplink Profile

You can configure PPPOE settings from the AOS-W Instant UI or CLI.

In the AOS-W Instant UI

1. Click the **System** link at the top right corner of the AOS-W Instant main window. The **System** window is displayed.
2. Click the **Show advanced options** link. The advanced options are displayed.
3. In the **Uplink** tab, perform the following steps in the **PPPoE** section:
 - a. Enter the **PPPoE service name** provided by your service provider in the **Service name** field.
 - b. In the **CHAP secret** and **Retype** fields, enter the secret key used for Challenge Handshake Authentication Protocol (CHAP) authentication. You can use a maximum of 34 characters for the CHAP secret key.
 - c. Enter the user name for the PPPoE connection in the **User** field.

- d. In the **Password** and **Retype** fields, enter a password for the PPPoE connection and confirm it.
4. To set a local interface for the PPPoE uplink connections, select a value from the **Local interface** drop-down list. The selected DHCP scope will be used as a local interface on the PPPoE interface and the Local, L3 DHCP gateway IP address as its local IP address. When configured, the local interface acts as an unnumbered PPPoE interface and allows the entire Local, L3 DHCP subnet to be allocated to clients.



The options in the **Local interface** drop-down list are displayed only if a Local, L3 DHCP scope is configured on the OAW-IAP.

5. Click **OK**.
6. Reboot the OAW-IAP for the configuration to affect.

In the CLI

To configure a PPPoE uplink connection:

```
(Instant AP) (config) # pppoe-uplink-profile
(Instant AP) (pppoe-uplink-profile) # pppoe-svcname <service-name>
(Instant AP) (pppoe-uplink-profile) # pppoe-username <username>
(Instant AP) (pppoe-uplink-profile) # pppoe-passwd <password>
(Instant AP) (pppoe-uplink-profile) # pppoe-chapsecret <password>
(Instant AP) (pppoe-uplink-profile) # pppoe-unnumbered-local-l3-dhcp-profile <dhcp-profile>
(Instant AP) (pppoe-uplink-profile) # end
(Instant AP) # commit apply
```

To view the PPPoE configuration:

```
(Instant AP) # show pppoe config
```

```
PPPoE Configuration
```

```
-----
```

```
Type Value
```

```
---- ----
```

```
User testUser
```

```
Password 3c28ec1b82d3eef0e65371da2f39c4d49803e5b2bc88be0c
```

```
Service name internet03
```

```
CHAP secret 8e87644deda9364100719e017f88ebce
```

```
Unnumbered dhcp profile dhcpProfile1
```

To view the PPPoE status:

```
(Instant AP) # show pppoe status
```

```
pppoe uplink state:Suppressed.
```

Cellular Uplink

AOS-W Instant supports the use of 3G and 4G USB modems to provide the Internet backhaul to an Instant network. The 3G or 4G USB modems can be used to extend client connectivity to places where an Ethernet uplink cannot be configured. This enables the OAW-IAPs to automatically choose the available network in a specific region.



The 3G and 4G LTE USB modems can be provisioned on OAW-RAP3WN/3WNP, OAW-RAP108/109, and OAW-RAP155/155P.



OAW-RAP155/155P devices do not support the HSO module.

The following 3G modems are supported:

- USBConnect 881 (Sierra 881U)
- Quicksilver (Globetrotter ICON 322)
- UM100C (UTstarcom)
- Icon 452
- Aircard 250U (Sierra)
- USB 598 (Sierra)
- U300 (Franklin wireless)
- U301 (Franklin wireless)
- USB U760 for Virgin (Novatel)
- USB U720 (Novatel/Qualcomm)
- UM175 (Pantech)
- UM150 (Pantech)
- UMW190(Pantech)
- SXC-1080 (Qualcomm)
- Globetrotter ICON 225
- UMG181
- NTT DoCoMo L-05A (LG FOMA L05A)
- NTT DoCoMo L-02A
- ZTE WCDMA Technologies MSM (MF668?)
- Fivespot (ZTE)
- c-motech CNU-600
- ZTE AC2736
- SEC-8089 (EpiValley)
- Nokia CS-10
- NTT DoCoMo L-08C (LG)
- NTT DoCoMo L-02C (LG)
- Novatel MC545
- Huawei E220 for Movistar in Spain
- Huawei E180 for Movistar in Spain
- ZTE-MF820
- Huawei E173s-1
- Sierra 320
- Longcheer WM72
- U600 (3G mode)
- Sierra USB-306 (HK CLS/1010 (HK))
- Sierra 306/308 (Telstra (Aus))
- Sierra 503 PCIe (Telstra (Aus))
- Sierra 312 (Telstra (Aus))
- Aircard USB 308 (AT&T's Shockwave)
- Compass 597(Sierra) (Sprint)
- U597 (Sierra) (Verizon)

- Tstick C597(Sierra) (Telecom(NZ))
- Ovation U727 (Novatel) (Sprint)
- USB U727 (Novatel) (Verizon)
- USB U760 (Novatel) (Sprint)
- USB U760 (Novatel) (Verizon)
- Novatel MiFi 2200 (Verizon Mifi 2200)
- Huawei E272, E170, E220 (ATT)
- Huawei E169, E180,E220,E272 (Vodafone/SmarTone (HK))
- Huawei E160 (O2(UK))
- Huawei E160 (SFR (France))
- Huawei E220 (NZ and JP)
- Huawei E176G (Telstra (Aus))
- Huawei E1553, E176 (3/HUTCH (Aus))
- Huawei K4505 (Vodafone/SmarTone (HK))
- Huawei K4505 (Vodafone (UK))
- ZTE MF656 (Netcom (norway))
- ZTE MF636 (HK CSL/1010)
- ZTE MF633/MF636 (Telstra (Aus))
- ZTE MF637 (Orange in Israel)
- Huawei E180, E1692,E1762 (Optus (Aus))
- Huawei E1731 (Airtel-3G (India))
- Huawei E3765 (Vodafone (Aus))
- Huawei E3765 (T-Mobile (Germany))
- Huawei E1552 (SingTel)
- Huawei E1750 (T-Mobile (Germany))
- UGM 1831 (TMobile)
- Huawei D33HW (EMOBILE(Japan))
- Huawei GD01 (EMOBILE(Japan))
- Huawei EC150 (Reliance NetConnect+ (India))
- KDDI DATA07(Huawei) (KDDI (Japan))
- Huawei E353 (China Unicom)
- Huawei EC167 (China Telecom)
- Huawei E367 (Vodafone (UK))
- Huawei E352s-5 (T-Mobile (Germany))
- Huawei K4505 (Vodafone/SmarTone (HK))
- Huawei K4505 (Vodafone (UK))
- ZTE MF656 (Netcom (norway))
- ZTE MF636 (HK CSL/1010)
- ZTE MF633/MF636 (Telstra (Aus))
- ZTE MF637 (Orange in Israel)
- Huawei E180, E1692,E1762 (Optus (Aus))
- Huawei E1731 (Airtel-3G (India))

- Huawei E3765 (Vodafone (Aus))
- Huawei E3765 (T-Mobile (Germany))
- Huawei E1552 (SingTel)
- Huawei E1750 (T-Mobile (Germany))
- UGM 1831 (TMobile)
- Huawei D33HW (EMOBILE(Japan))
- Huawei GD01 (EMOBILE(Japan))
- Huawei EC150 (Reliance NetConnect+ (India))
- KDDI DATA07(Huawei) (KDDI (Japan))
- Huawei E353 (China Unicom)
- Huawei EC167 (China Telecom)
- Huawei E367 (Vodafone (UK))
- Huawei E352s-5 (T-Mobile (Germany))
- Huawei D41HW
- ZTE AC2726

The following table lists the supported 4G modems.

- Netgear AirCard 340U
- Netgear Aircard 341 U
- Franklin Wireless U770
- Novatel U620L
- Huawei E3276
- Novatel MC551L
- Pantech UML295
- Pantech UML290
- Huawei E3372
- Alcatel L800
- Sierra 340U
- Sierra 320U
- Sierra 330U

Starting from AOS-W Instant 6.4.0.2-4.1 release, all modems (except Huawei E3372) are detected automatically by the OAW-IAP.



When UML290 runs in auto detect mode, the modem can switch from 4G network to 3G network or vice-versa based on the signal strength. To configure the UML290 for the 3G network only, manually set the USB type to **pantech-3g**. To configure the UML290 for the 4G network only, manually set the 4G USB type to **pantech-lte**.

Configuring Cellular Uplink Profiles

You can configure 3G or 4G uplinks using the AOS-W Instant UI or CLI.

In the AOS-W Instant UI

1. Click the **System** link at the upper right corner of the AOS-W Instant main window. The **System** window is displayed.
2. In the **System** window, click the **show advanced settings** link. The advanced options are displayed.

3. Click the **Uplink** tab.
4. To configure a 3G or 4G uplink, select the **Country** and **ISP**.
5. Click **OK**.
6. Reboot the OAW-IAP for changes to affect.

In the CLI

To configure 3G/4G uplink manually:

```
(Instant AP) (config) # cellular-uplink-profile
(Instant AP) (cellular-uplink-profile) # usb-type <3G-usb-type>
(Instant AP) (cellular-uplink-profile) # 4g-usb-type <4g-usb>
(Instant AP) (cellular-uplink-profile) # modem-country <country>
(Instant AP) (cellular-uplink-profile) # modem-isp <service-provider-name>
(Instant AP) (cellular-uplink-profile) # usb-auth-type <usb-authentication_type>
(Instant AP) (cellular-uplink-profile) # usb-user <username>
(Instant AP) (cellular-uplink-profile) # usb-passwd <password>
(Instant AP) (cellular-uplink-profile) # usb-dev <device-ID>
(Instant AP) (cellular-uplink-profile) # usb-tty <tty-port>
(Instant AP) (cellular-uplink-profile) # usb-init <Initialization-parameter>
(Instant AP) (cellular-uplink-profile) # usb-dial <dial-parameter>
(Instant AP) (cellular-uplink-profile) # usb-modeswitch <usb-modem>
(Instant AP) (cellular-uplink-profile) # end
(Instant AP) # commit apply
```

To switch a modem from the storage mode to modem mode:

```
(Instant AP) (cellular-uplink-profile) # usb-modeswitch <usb-modem>
```

To view the cellular configuration:

```
(Instant AP) # show cellular config
```

Managing Cellular SIM PIN

OAW-IAPs now support the SIM PIN management functions such as locking, unlocking, and renewing the SIM PIN of the 3G/4G modems. In the current release, these functions can be configured only through the OAW-IAP CLI.

To prevent the fraudulent use of 3G/4G modems connected to an OAW-IAP, you can enable locking of the SIM PIN of the modems. When enabled, if an incorrect PIN code for the three consecutive attempts, the SIM PIN is locked. To unlock the PIN, the users must use the PUK code provided by your ISP.



After enabling SIM PIN lock, reboot the AP to apply the SIM PIN lock configuration changes.

To enable SIM PIN lock:

```
(Instant AP) # pin-enable <pin_current_used>
```

To disable SIM PIN locking:

```
(Instant AP) # no pin-enable <pin_current_used>
```

To unlock a PIN with the PUK code provided by the operator:

```
(Instant AP) # pin-puk <pin_puk> <pin_new>
```

To renew the PIN:

```
(Instant AP) # pin-renew <pin_current> <pin_new>
```

Wi-Fi Uplink

The Wi-Fi uplink is supported on all the OAW-IAP models, except for the 802.11ac AP models (OAW-IAP-2xx Series access points). However only the master OAW-IAP uses this uplink. The Wi-Fi allows uplink to open, PSK-CCMP, and PSK-TKIP SSIDs.

- For single radio OAW-IAPs, the radio serves wireless clients and the Wi-Fi uplink.
- For dual radio OAW-IAPs, both radios can be used to serve clients but only one of them can be used for the Wi-Fi uplink.



When the Wi-Fi uplink is in use, the client IP is assigned by the internal DHCP server.

Configuring a Wi-Fi Uplink Profile

The following configuration conditions apply to the Wi-Fi uplink:

- To bind or unbind the Wi-Fi uplink on the 5 GHz band, reboot the OAW-IAP.
- If the Wi-Fi uplink is used on the 5 GHz band, mesh is disabled. The two links are mutually exclusive.
- For OAW-IAPs to connect to an AOS-W Instant based WLAN using Wi-Fi uplink, the switch must run AOS-W Instant 6.2.1.0 or later.

In the AOS-W Instant UI

To provision an OAW-IAP with the Wi-Fi uplink in the UI, complete the following steps:

1. If you are configuring a Wi-Fi uplink after restoring factory settings on an OAW-IAP, connect the OAW-IAP to an Ethernet cable to allow the OAW-IAP to get the IP address. Otherwise, go to step 2.
2. Click the **System** link at the top right corner of the AOS-W Instant main window. The **System** window is displayed.
3. Click the **Show advanced options** link. The advanced options are displayed.
4. Click the **Uplink** tab.
5. Under Wi-Fi, enter the name of the wireless network that is used for the Wi-Fi uplink in the **Name (SSID)** text box.
6. Select the type of key for uplink encryption and authentication from the **Key management** drop-down list. If the uplink wireless router uses mixed encryption, WPA-2 is recommended for the Wi-Fi uplink.
7. From the **band** drop-down list. Select the band in which the Virtual Controller currently operates. The following options are available:
 - 2.4 GHz (default)
 - 5 GHz
8. Select a passphrase format from the **Passphrase format** drop-down list. The following options are available:
 - 8 - 63 alphanumeric characters
 - 64 hexadecimal characters



Ensure that the hexadecimal password string is exactly 64 digits in length.

9. Enter a pre-shared key (PSK) passphrase in the **Passphrase** text box and click **OK**.
10. Navigate to **System > General > Show Advanced Options** view and set the **Extended SSID** parameter to **Disabled**.

11.Reboot the OAW-IAP to apply the changes. After the OAW-IAP reboot, the Wi-Fi and mesh links are automatically enabled.

In the CLI

To configure Wi-Fi uplink on an OAW-IAP:

```
(Instant AP) (config) # wlan sta-profile
(Instant AP) (sta uplink)# cipher-suite<clear|wpa-tkip-psk|wpa2-ccmp-psk>
(Instant AP) (sta uplink)# essid <essid>
(Instant AP) (sta uplink)# uplink-band <band>
(Instant AP) (sta uplink)# wpa-passphrase <key>
(Instant AP) (sta uplink)# end
(Instant AP) # commit apply
```

To view the W-Fi uplink status in the CLI.

```
(Instant AP) # show wifi-uplink status
configured :NO
```

To view the configuration status in the CLI:

```
(Instant AP) # show wifi-uplink config
```

```
ESSID :
Cipher Suite :
Passphrase :
Band :
```

```
(Instant AP) # show wifi-uplink auth log
```

```
-----
wifi uplink auth configuration:
-----
```

```
wifi uplink auth log:
-----
```

```
[11116]2000-01-01 00:00:45.625: Global control interface '/tmp/supp_gbl'
```

Uplink Preferences and Switching

This topic describes the following procedures:

- [Enforcing Uplinks on page 326](#)
- [Setting an Uplink Priority on page 327](#)
- [Enabling Uplink Preemption on page 327](#)
- [Switching Uplinks Based on VPN and Internet Availability on page 328](#)
- [Viewing Uplink Status and Configuration on page 329](#)

Enforcing Uplinks

The following configuration conditions apply to the uplink enforcement:

- When an uplink is enforced, the OAW-IAP uses the specified uplink as the primary uplink regardless of uplink preemption configuration and the current uplink status.
- When an uplink is enforced and multiple Ethernet ports are configured and uplink is enabled on the wired profiles, the OAW-IAP tries to find an alternate Ethernet link based on the priority configured.
- When no uplink is enforced and preemption is not enabled, and if the current uplink fails, the OAW-IAP tries to find an available uplink based on the priority configured. The uplink with the highest priority is used as the primary uplink. For example, if Wifi-sta has the highest priority, it is used as the primary uplink.

- When no uplink is enforced and preemption is enabled, and if the current uplink fails, the OAW-IAP tries to find an available uplink based on the priority configured. If current uplink is active, the OAW-IAP periodically tries to use a higher priority uplink and switches to the higher priority uplink even if the current uplink is active.

You can enforce a specific uplink on an OAW-IAP by using the AOS-W Instant UI or CLI.

In the AOS-W Instant UI

To enforce an uplink:

1. Click the **System > show advanced settings > Uplink**. The **Uplink** tab contents are displayed.
2. Under **Management**, select the type of uplink from the **Enforce Uplink** drop-down list. If Ethernet uplink is selected, the **Port** field is displayed.
3. Specify the Ethernet interface port number.
4. Click **OK**. The selected uplink is enforced on the OAW-IAP.

In the CLI

To enforce an uplink:

```
(Instant AP) (config)# uplink
(Instant AP) (uplink)# enforce {cellular|ethernet|wifi|none}
(Instant AP) (uplink)# end
(Instant AP)# commit apply
```

Setting an Uplink Priority

You can set an uplink priority by using the AOS-W Instant UI or CLI.

In the AOS-W Instant UI

1. Click the **System > show advanced settings > Uplink**. The **Uplink** tab contents are displayed.
2. Under **Uplink Priority List**, select the uplink, and click the icons at the bottom of the **Uplink Priority List** section, to increase or decrease the priority. By default, the Eth0 uplink is set as a high priority uplink.
3. Click **OK**. The selected uplink is prioritized over other uplinks.

In the CLI

To set an uplink priority:

```
(Instant AP) (config)# uplink
(Instant AP) (uplink)# uplink-priority {cellular <priority> | ethernet <priority>|[port
<Interface-number> <priority>]|wifi <priority>}
(Instant AP) (uplink)# end
(Instant AP)# commit apply
```

For example, to set a priority for Ethernet uplink:

```
(Instant AP) (uplink)# uplink-priority ethernet port 0 1
(Instant AP) (uplink)# end
(Instant AP)# commit apply
```

Enabling Uplink Preemption

The following configuration conditions apply to uplink preemption:

- Preemption can be enabled only when no uplink is enforced.
- When preemption is disabled and the current uplink goes down, the OAW-IAP tries to find an available uplink based on the uplink priority configuration.
- When preemption is enabled and if the current uplink is active, the OAW-IAP periodically tries to use a higher priority uplink, and switches to a higher priority uplink even if the current uplink is active.

You can enable uplink preemption using AOS-W Instant UI or CLI.

In the AOS-W Instant UI

1. Click the **System** > **show advanced settings** > **Uplink**. The **Uplink** tab contents are displayed.
2. Under **Management**, ensure that the **Enforce Uplink** is set to none.
3. Select **Enabled** from the **Pre-emption** drop-down list.
4. Click **OK**.

In the CLI

To enable uplink preemption:

```
(Instant AP) (config) # uplink
(Instant AP) (uplink) # preemption
(Instant AP) (uplink) # end
(Instant AP) # commit apply
```

Switching Uplinks Based on VPN and Internet Availability

The default priority for uplink switchover is Ethernet and then 3G/4G. The OAW-IAP can switch to the lower priority uplink if the current uplink is down.

Switching Uplinks Based on VPN Status

AOS-W Instant supports switching uplinks based on the VPN status when deploying multiple uplinks (Ethernet, 3G/4G, and Wi-Fi). When VPN is used with multiple backhaul options, the OAW-IAP switches to an uplink connection based on the VPN connection status, instead of only using the Ethernet or the physical backhaul link.

The following configuration conditions apply to uplink switching:

- If the current uplink is Ethernet and the VPN connection is down, the OAW-IAP tries to reconnect to VPN. The retry time depends on the fast failover configuration and the primary or backup VPN tunnel. If this fails, the OAW-IAP waits for the VPN failover timeout and selects a different uplink such as 3G/4G or Wi-Fi.
- If the current uplink is 3G or Wi-Fi, and Ethernet has a physical link, the OAW-IAP periodically suspends user traffic to try and connect to the VPN on the Ethernet. If the OAW-IAP succeeds, the OAW-IAP switches to Ethernet. If the OAW-IAP does not succeed, it restores the VPN connection to the current uplink.

Uplink switching based on VPN status is automatically enabled if VPN is configured on the OAW-IAP. However, you can specify the duration in **VPN failover timeout** field to wait for an uplink switch. By default, this duration is set to 180 seconds. The OAW-IAP monitors the VPN status and when the VPN connection is not available for 3 minutes, the uplink switches to another available connection (if a low priority uplink is detected and the uplink preference is set to none). When **VPN failover timeout** is set to 0, uplink does not switch over.

When uplink switching based on the Internet availability is enabled, the uplink switching based on VPN failover is automatically disabled.

Switching Uplinks Based on Internet Availability

You can configure AOS-W Instant to switch uplinks based on Internet availability.

When the uplink switchover based on Internet availability is enabled, the OAW-IAP continuously sends ICMP packets to some well-known Internet servers. If the request is timed out due to a bad uplink connection or uplink interface failure, and the public Internet is not reachable from the current uplink, the OAW-IAP switches to a different connection.

You can set preferences for uplink switching using the AOS-W Instant UI and CLI.

In the AOS-W Instant UI

To configure uplink switching:

1. Click the **System > show advanced settings > Uplink**. The **Uplink** tab contents are displayed.
2. Under **Management**, configure the following parameters:
 - **VPN failover timeout**—To configure uplink switching based on VPN status, specify the duration to wait for an uplink switch. The default duration is set to 180 seconds.
 - **Internet failover**—To configure uplink switching based on Internet availability, perform the following steps:
 - a. Select **Enabled** from the **Internet failover** drop-down list.
 - b. Specify the required values for the following fields:
 - **Max allowed test packet loss**— The maximum number of ICMP test packets that are allowed to be lost to determine if the OAW-IAP must switch to a different uplink connection. You can specify a value within the range of 1—1000.
 - **Secs between test packets**— The frequency at which ICMP test packets are sent. You can specify a value within the range of 1—3600 seconds.
 - **Internet check timeout**— Internet check timeout is the duration for the test packet timeout. You can specify a value within the range of 0—3600 seconds and the default value is 10 seconds.
 - **Internet failover IP**—To configure an IP address to which the OAW-IAP must send OAW-IAP packets to verify if the Internet is reachable when the uplink is down. By default, the master OAW-IAP sends the ICMP packets to 8.8.8.8 IP address only if the out-of-service operation based on Internet availability (internet-down state) is configured on the SSID.
3. Click **OK**.



When **Internet failover** is enabled, the OAW-IAP ignores the VPN status, although uplink switching based on VPN status is enabled.

In the CLI

To enable uplink switching based on VPN status:

```
(Instant AP) (config) # uplink
(Instant AP) (uplink) # failover-vpn-timeout <seconds>
(Instant AP) (uplink) # end
(Instant AP) # commit apply
```

To enable uplink switching based on Internet availability:

```
(Instant AP) (config) # uplink
(Instant AP) (uplink) # failover-internet
(Instant AP) (uplink) # failover-internet-ip <ip>
(Instant AP) (uplink) # failover-internet-pkt-lost-cnt <count>
(Instant AP) (uplink) # failover-internet-pkt-send-freq <frequency>
(Instant AP) (uplink) # end
(Instant AP) # commit apply
```

Viewing Uplink Status and Configuration

To view the uplink status in the CLI:

```
Instant Access Point# show uplink status
Uplink preemption           :enable
Uplink preemption interval  :600
Uplink enforce              :none
```

```

Ethernet uplink eth0          :DHCP
Uplink Table
-----
Type      State  Priority  In Use
----      -
eth0      UP     2         Yes
Wifi-sta  INIT   1         No
3G/4G     INIT   3         No
Internet failover             :enable
Internet failover IP         :192.2.0.1
Max allowed test packet loss :10
Secs between test packets    :30
VPN failover timeout (secs)  :180
Internet check timeout (secs):10
ICMP pkt sent                :1
ICMP pkt lost                 :1
Continuous pkt lost          :1
VPN down time                 :0
AP1X type:NONE
Certification type:NONE
Validate server:NONE

```

To view the uplink configuration in the CLI:

```

Instant Access Point# show uplink config
Uplink preemption             :enable
Uplink preemption interval    :600
Uplink enforce                :none
Ethernet uplink eth0         :DHCP
Internet failover             :disable
Max allowed test packet loss  :10
Secs between test packets     :30
VPN failover timeout (secs)   :180
Internet check timeout (secs) :10
Secs between test packets     :30

```

The Intrusion Detection System (IDS) is a feature that monitors the network for the presence of unauthorized OAW-IAPs and clients. It also logs information about the unauthorized OAW-IAPs and clients, and generates reports based on the logged information.

The IDS feature in the AOS-W Instant network enables you to detect rogue APs, interfering APs, and other devices that can potentially disrupt network operations.

This chapter describes the following procedures:

- [Detecting and Classifying Rogue APs on page 331](#)
- [OS Fingerprinting on page 331](#)
- [Configuring Wireless Intrusion Protection and Detection Levels on page 332](#)
- [Configuring IDS Using CLI on page 337](#)

Detecting and Classifying Rogue APs

A rogue AP is an unauthorized AP plugged into the wired side of the network.

An interfering AP is an AP seen in the RF environment but it is not connected to the wired network. While the interfering AP can potentially cause RF interference, it is not considered a direct security threat, because it is not connected to the wired network. However, an interfering AP may be reclassified as a rogue AP.

To detect the rogue APs, click the **IDS** link in the AOS-W Instant main window. The built-in IDS scans for access points that are not controlled by the Virtual Controller. These are listed and classified as either Interfering or Rogue, depending on whether they are on a foreign network or your network.

Figure 95 *Intrusion Detection*

Foreign Access Points Detected							Foreign Clients Detected						
MAC address	Network	Classification	Chan.	Type	Last Seen	Where	MAC address	Network	Classification	Chan.	Type	Last Seen	Where
00:24:6c:82:48:72	docomo	Interfering	1	G	11:31:07		00:26:c6:b7:7a:76	ethersphere-voip	Interfering	1	GN 20MZ	11:31:07	
00:0b:86:b6:29:31	NTT-SPOT	Interfering	1	G	11:31:07		1c1b0:94:a1:9e:b6	ethersphere-wpa2	Interfering	1	GN 20MZ	11:31:07	
00:24:6c:80:a4:b2	docomo	Interfering	1	G	11:31:07		58:94:6b:57:5b:38	ethersphere-wpa2	Interfering	1	GN 20MZ	11:31:07	
00:24:6c:0f:9d:42	docomo	Interfering	1	G	11:31:07		24:77:03:7a:67:5c	UL_Dashboard	Interfering	1	G	11:31:07	
00:24:6c:b0:bca:e2	docomo	Interfering	1	G	11:31:07		00:1e:65:30:7e:d8	ethersphere-wpa2	Interfering	1	GN 20MZ	11:30:51	
00:24:6c:aa:9a:d0	aruba-ap	Interfering	1	GN 20MZ	11:31:07		04:46:65:8c:00:aa	ethersphere-wpa2	Interfering	1	GN 20MZ	11:30:35	
00:0b:86:b6:34:b2	docomo	Interfering	1	G	11:31:07		24:77:03:7a:65:ec	ipv6-alpha	Interfering	1	GN 20MZ	11:30:35	
00:0b:86:b6:29:32	docomo	Interfering	1	G	11:31:07		00:37:6d:e2:df:b2	ethersphere-voip	Interfering	1	GN 20MZ	11:30:20	
00:24:6c:33:0c:11	NTT-SPOT	Interfering	1	G	11:31:07		00:03:2a:02:5b:b7	akvoicel	Interfering	1	G	11:30:20	
8c1f3:7f:18:6d:08	hotspot_cach	Interfering	157	AN 40MZ	11:31:07		20:02:af:9e:4b:b5	ethersphere-wpa2	Interfering	1	GN 20MZ	11:29:34	
00:24:6c:33:0c:12	docomo	Interfering	1	G	11:31:07		00:17:ca:ae:7a:a6	ethersphere-voip	Interfering	1	B	11:29:05	
8c1f3:7f:18:6d:20	nrvap1	Interfering	1	GN 20MZ	11:31:07		84:29:99:11:35:0d	mdns-roaming	Interfering	11	GN 20MZ	11:29:05	
d8:c7:c8:27:33:a5	sandip-test	Interfering	11	GN 20MZ	11:31:07		5c:0a:5b:13:a5:cd	ethersphere-voip	Interfering	11	GN 20MZ	11:28:50	
00:24:6c:0b:30:40	7SPOT	Interfering	1	GN 20MZ	11:31:07		20:64:32:51:fc:3f	ipv6-alpha	Interfering	1	GN 20MZ	11:27:49	
00:24:6c:06:82:d0	7SPOT	Interfering	1	GN 20MZ	11:31:07		20:64:32:81:d2:37	ethersphere-wpa2	Interfering	1	BN 20MZ	11:23:34	
00:24:6c:80:4b:f1	ARUBA-VISITOR	Interfering	1	GN 20MZ	11:31:07		58:94:6b:31:cf:00	mdns-roaming	Interfering	11	B	11:21:49	
00:0b:86:70:4b:f1	san-mdns-pak	Interfering	1	GN 20MZ	11:31:07		00:16:6f:31:8b:8a	UL_Dashboard	Interfering	6	G	11:18:18	
d8:c7:c8:27:33:c2	Millford_Staff	Interfering	1	GN 20MZ	11:31:07		00:26:c6:b6:68:b8	ethersphere-voip	Interfering	6	GN 20MZ	11:18:18	

OS Fingerprinting

The OS Fingerprinting feature gathers information about the client that is connected to the AOS-W Instant network to find the operating system that the client is running on. The following is a list of advantages of this feature:

- Identifying rogue clients— Helps to identify clients that are running on forbidden operating systems.
- Identifying outdated operating systems— Helps to locate outdated and unexpected OS in the company network.
- Locating and patching vulnerable operating systems— Assists in locating and patching specific operating system versions on the network that have known vulnerabilities, thereby securing the company network.

OS Fingerprinting is enabled in the AOS-W Instant network by default. The following operating systems are identified by AOS-W Instant:

- Windows 7
- Windows Vista
- Windows Server
- Windows XP
- Windows ME
- OS-X
- iPhone
- iOS
- Android
- Blackberry
- Linux

Configuring Wireless Intrusion Protection and Detection Levels

WIP offers a wide selection of intrusion detection and protection features to protect the network against wireless threats.

Like most other security-related features of the AOS-W Instant network, the WIP can be configured on the OAW-IAP.

You can configure the following options:

- **Infrastructure Detection Policies**— Specifies the policy for detecting wireless attacks on access points.
- **Client Detection Policies**— Specifies the policy for detecting wireless attacks on clients.
- **Infrastructure Protection Policies**— Specifies the policy for protecting access points from wireless attacks.
- **Client Protection Policies**— Specifies the policy for protecting clients from wireless attacks.
- **Containment Methods**— Prevents unauthorized stations from connecting to your AOS-W Instant network.

Each of these options contains several default levels that enable different sets of policies. An administrator can customize enable or disable these options accordingly.

The detection levels can be configured using the **IDS** window. To view the IDS window, click **More > IDS** link at the top right corner of the Instant main window. The following levels of detection can be configured in the WIP Detection page:

- **Off**
- **Low**
- **Medium**
- **High**

Figure 96 *Wireless Intrusion Detection*

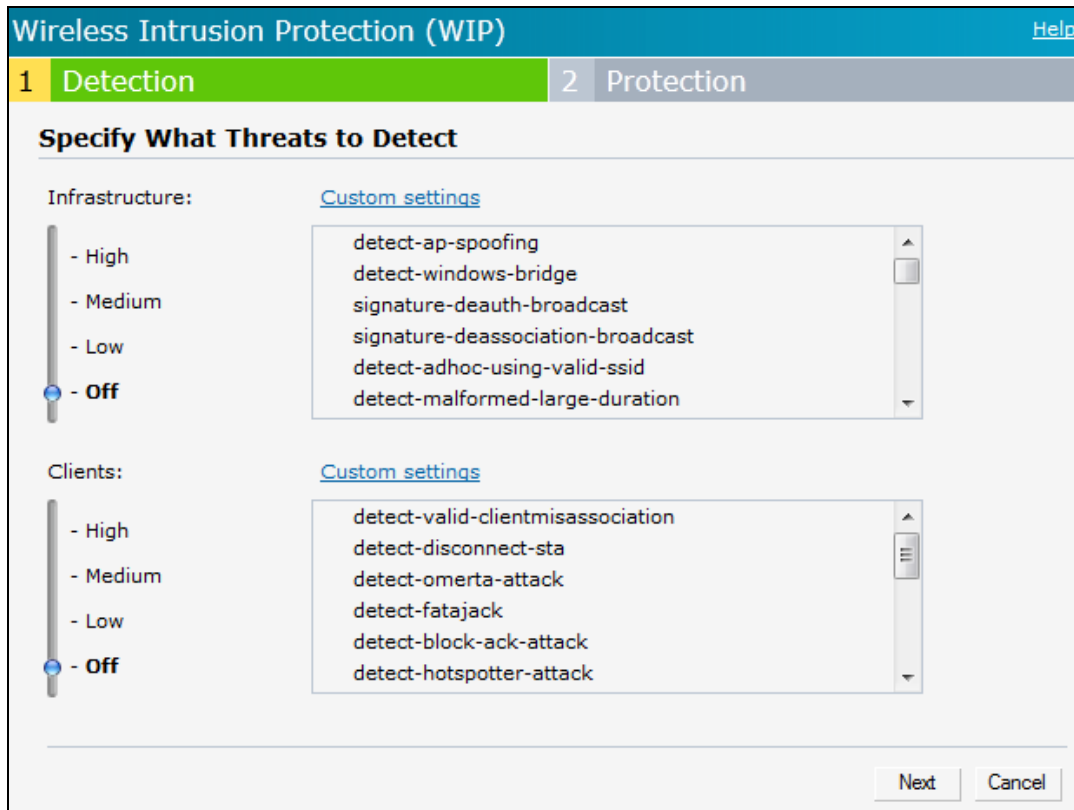

The following table describes the detection policies enabled in the Infrastructure Detection **Custom settings** field.

Table 63: *Infrastructure Detection Policies*

Detection Level	Detection Policy
Off	Rogue Classification
Low	<ul style="list-style-type: none"> • Detect AP Spoofing • Detect Windows Bridge • IDS Signature— Deauthentication Broadcast • IDS Signature— Deassociation Broadcast
Medium	<ul style="list-style-type: none"> • Detect Adhoc networks using VALID SSID— Valid SSID list is auto-configured based on Instant AP configuration • Detect Malformed Frame— Large Duration
High	<ul style="list-style-type: none"> • Detect AP Impersonation • Detect Adhoc Networks • Detect Valid SSID Misuse • Detect Wireless Bridge • Detect 802.11 40MHz intolerance settings • Detect Active 802.11 n Greenfield Mode

Table 63: *Infrastructure Detection Policies*

Detection Level	Detection Policy
	<ul style="list-style-type: none">• Detect AP Flood Attack• Detect Client Flood Attack• Detect Bad WEP• Detect CTS Rate Anomaly• Detect RTS Rate Anomaly• Detect Invalid Address Combination• Detect Malformed Frame— HT IE• Detect Malformed Frame— Association Request• Detect Malformed Frame— Auth• Detect Overflow IE• Detect Overflow EAPOL Key• Detect Beacon Wrong Channel• Detect devices with invalid MAC OUI

The following table describes the detection policies enabled in the Client Detection **Custom settings** field.

Table 64: *Client Detection Policies*

Detection Level	Detection Policy
Off	All detection policies are disabled.
Low	<ul style="list-style-type: none">• Detect Valid Station Misassociation
Medium	<ul style="list-style-type: none">• Detect Disconnect Station Attack• Detect Omerta Attack• Detect FATA-Jack Attack• Detect Block ACK DOS• Detect Hotspotter Attack• Detect unencrypted Valid Client• Detect Power Save DOS Attack
High	<ul style="list-style-type: none">• Detect EAP Rate Anomaly• Detect Rate Anomaly• Detect Chop Chop Attack• Detect TKIP Replay Attack• IDS Signature— Air Jack• IDS Signature— ASLEAP

The following levels of detection can be configured in the WIP Protection page:

- **Off**
- **Low**

- High

Figure 97 *Wireless Intrusion Protection*



The following table describes the protection policies that are enabled in the Infrastructure Protection **Custom settings** field.

Table 65: *Infrastructure Protection Policies*

Protection Level	Protection Policy
Off	All protection policies are disabled
Low	<ul style="list-style-type: none"> • Protect SSID – Valid SSID list should be auto derived from Instant configuration • Rogue Containment
High	<ul style="list-style-type: none"> • Protect from Adhoc Networks • Protect AP Impersonation

The following table describes the detection policies that are enabled in the Client Protection **Custom settings** field.

Table 66: *Client Protection Policies*

Protection Level	Protection Policy
Off	All protection policies are disabled
Low	Protect Valid Station
High	Protect Windows Bridge

Containment Methods

You can enable wired and wireless containments to prevent unauthorized stations from connecting to your AOS-W Instant network.

AOS-W Instant supports the following types of containment mechanisms:

- Wired containment— When enabled, OAW-IAPs generate ARP packets on the wired network to contain wireless attacks.
 - `wired-containment-ap-adj-mac`—Enables a wired containment to Rogue APs whose wired interface MAC address is offset by one from its BSSID.
 - `wired-containment-susp-l3-rogue`—Enables the users to identify and contain an AP with a preset MAC address that is different from the BSSID of the AP, if the MAC address that the AP provides is offset by one character from its wired MAC address.



Enable the **`wired-containment-susp-l3-rogue`** knob only when a specific containment is required, to avoid a false alarm.

- Wireless containment— When enabled, the system attempts to disconnect all clients that are connected or attempting to connect to the identified Access Point.
 - None— Disables all the containment mechanisms.
 - Deauthenticate only— With deauthentication containment, the Access Point or client is contained by disrupting the client association on the wireless interface.
 - Tarpit containment— With Tarpit containment, the Access Point is contained by luring clients that are attempting to associate with it to a tarpit. The tarpit can be on the same channel or a different channel as the Access Point being contained.

Figure 98 Containment Methods

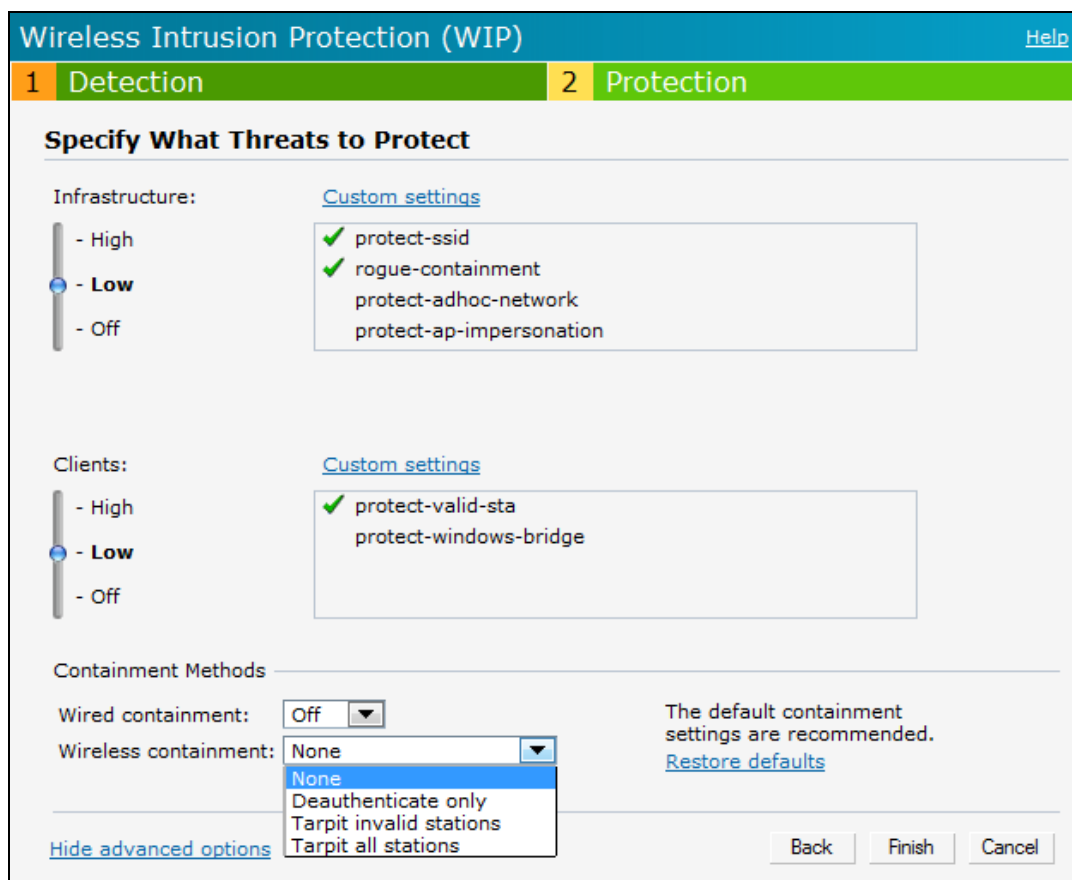

Configuring IDS Using CLI

To configure IDS using CLI:

```
(Instant AP) (config)# ids
(Instant AP) (IDS)# infrastructure-detection-level <type>
(Instant AP) (IDS)# client-detection-level <type>
(Instant AP) (IDS)# infrastructure-protection-level <type>
(Instant AP) (IDS)# client-protection-level <type>
(Instant AP) (IDS)# wireless-containment <type>
(Instant AP) (IDS)# wired-containment
(Instant AP) (IDS)# wired-containment-ap-adj-mac
(Instant AP) (IDS)# wired-containment-susp-l3-rogue
(Instant AP) (IDS)# detect-ap-spoofing
(Instant AP) (IDS)# detect-windows-bridge
(Instant AP) (IDS)# signature-death-broadcast
(Instant AP) (IDS)# signature-deassociation-broadcast
(Instant AP) (IDS)# detect-adhoc-using-valid-ssid
(Instant AP) (IDS)# detect-malformed-large-duration
(Instant AP) (IDS)# detect-ap-impersonation
(Instant AP) (IDS)# detect-adhoc-network
(Instant AP) (IDS)# detect-valid-ssid-misuse
(Instant AP) (IDS)# detect-wireless-bridge
(Instant AP) (IDS)# detect-ht-40mhz-intolerance
(Instant AP) (IDS)# detect-ht-greenfield
(Instant AP) (IDS)# detect-ap-flood
(Instant AP) (IDS)# detect-client-flood
(Instant AP) (IDS)# detect-bad-wep
(Instant AP) (IDS)# detect-cts-rate-anomaly
```

```
(Instant AP) (IDS) # detect-rts-rate-anomaly
(Instant AP) (IDS) # detect-invalid-addresscombination
(Instant AP) (IDS) # detect-malformed-htie
(Instant AP) (IDS) # detect-malformed-assoc-req
(Instant AP) (IDS) # detect-malformed-frame-auth
(Instant AP) (IDS) # detect-overflow-ie
(Instant AP) (IDS) # detect-overflow-eapol-key
(Instant AP) (IDS) # detect-beacon-wrong-channel
(Instant AP) (IDS) # detect-invalid-mac-oui
(Instant AP) (IDS) # detect-valid-clientmisassociation
(Instant AP) (IDS) # detect-disconnect-sta
(Instant AP) (IDS) # detect-omerta-attack
(Instant AP) (IDS) # detect-fatajack
(Instant AP) (IDS) # detect-block-ack-attack
(Instant AP) (IDS) # detect-hotspotter-attack
(Instant AP) (IDS) # detect-unencrypted-valid
(Instant AP) (IDS) # detect-power-save-dos-attack
(Instant AP) (IDS) # detect-eap-rate-anomaly
(Instant AP) (IDS) # detect-rate-anomalies
(Instant AP) (IDS) # detect-chopchop-attack
(Instant AP) (IDS) # detect-tkip-replay-attack
(Instant AP) (IDS) # signature-airjack
(Instant AP) (IDS) # signature-asleep
(Instant AP) (IDS) # protect-ssid
(Instant AP) (IDS) # rogue-containment
(Instant AP) (IDS) # protect-adhoc-network
(Instant AP) (IDS) # protect-ap-impersonation
(Instant AP) (IDS) # protect-valid-sta
(Instant AP) (IDS) # protect-windows-bridge
(Instant AP) (IDS) # end
(Instant AP) # commit apply
```

This chapter provides the following information:

- [Mesh Network Overview on page 339](#)
- [Setting up AOS-W Instant Mesh Network on page 340](#)
- [Configuring Wired Bridging on Ethernet 0 for Mesh Point on page 340](#)

Mesh Network Overview

The AOS-W Instant secure enterprise mesh solution is an effective way to expand network coverage for outdoor and indoor enterprise environments without any wires. As traffic traverses across mesh OAW-IAPs, the mesh network automatically reconfigures around broken or blocked paths. This self-healing feature provides increased reliability and redundancy and allows the network to continue operation even when an OAW-IAP stops functioning or if a connection fails.

Mesh OAW-IAPs

Mesh network requires at least one valid uplink (wired or 3G) connection. Any provisioned OAW-IAP that has a valid uplink (wired or 3G) functions as a mesh portal, and the OAW-IAP without an Ethernet link functions as a mesh point. The mesh portal can also act as a Virtual Controller. Mesh portals and mesh points are also known as mesh nodes, a generic term used to describe OAW-IAPs configured for mesh.

If two OAW-IAPs have valid uplink connections, there is redundancy in the mesh network, and most mesh points try to mesh directly with one of the two portals. However, depending on the actual deployment and RF environment, some mesh points may mesh through other intermediate mesh points.

In an AOS-W Instant mesh network, the maximum hop count is two nodes (point >point >portal) and the maximum number of mesh points per mesh portal is eight.

Mesh OAW-IAPs detect the environment when they boot up, locate and associate with their nearest neighbor, to determine the best path to the mesh portal.

AOS-W Instant mesh functionality is supported only on dual radio OAW-IAPs only. On dual-radio OAW-IAPs, the 5 GHz radio is always used for both mesh-backhaul and client traffic, while the 2.4 GHz radio is always used for client traffic.



Mesh service is automatically enabled on 802.11a band for dual-radio OAW-IAP only, and this is not configurable.

For OAW-IAP-RW variants, the mesh network must be provisioned for the first time by plugging into the wired network. After that, mesh works on OAW-IAP-RWs like any other regulatory domain.

Mesh Portals

A mesh portal (MPP) is a gateway between the wireless mesh network and the enterprise wired LAN. The mesh roles are automatically assigned based on the OAW-IAP configuration. A mesh network could have multiple mesh portals to support redundant mesh paths (mesh links between neighboring mesh points that establish the best path to the mesh portal) from the wireless mesh network to the wired LAN.

The mesh portal broadcasts a mesh services set identifier (MSSID/ mesh cluster name) to advertise the mesh network service to other mesh points in that AOS-W Instant network. This is not configurable and is transparent to the user. The mesh points authenticate to the mesh portal and establish a link that is secured using Advanced Encryption Standard (AES) encryption.



The mesh portal reboots after 5 minutes when it loses its uplink connectivity to a wired network.

Mesh Points

The mesh point establishes an all-wireless path to the mesh portal. The mesh point provides traditional WLAN services such as client connectivity, intrusion detection system (IDS) capabilities, user role association, and Quality of Service (QoS) for LAN-to-mesh communication to clients and performs mesh backhaul/network connectivity.



Mesh point also supports LAN bridging. You can connect any wired device to the downlink port of the mesh point. In the case of single Ethernet port platforms such as OAW-IAP105, you can convert the Eth0 uplink port to a downlink port by enabling **Eth0 Bridging**. For additional information, see [Configuring Wired Bridging on Ethernet 0 for Mesh Point on page 340](#).

Setting up AOS-W Instant Mesh Network

Starting from AOS-W Instant 6.4.0.2-4.1 release, mesh functionality is disabled by default, because of which over-the-air provisioning of mesh OAW-IAPs is not supported.

To provision OAW-IAPs as mesh OAW-IAPs:

1. Connect the OAW-IAPs to a wired switch.
2. Ensure that the Virtual Controller key is synchronized and the country code is configured.
3. Ensure that a valid SSID is configured on the OAW-IAP.
4. If the OAW-IAP has a factory default SSID (instant SSID), delete the SSID.
5. If an extended SSID is enabled on the virtual controller, disable it and reboot the OAW-IAP cluster.
6. Disconnect the OAW-IAPs that you want to deploy as mesh points from the switch and place the OAW-IAPs at a remote location. The OAW-IAPs power on without any wired uplink connection and function as mesh points and the OAW-IAPs with valid uplink connections function as the mesh portal.



AOS-W Instant does not support the topology in which the OAW-IAPs are connected to the downlink Ethernet port of a mesh point.

Configuring Wired Bridging on Ethernet 0 for Mesh Point

AOS-W Instant supports wired bridging on the Ethernet 0 port of an OAW-IAP. If OAW-IAP is configured to function as a mesh point, you can configure wired bridging.



Enabling wired bridging on this port of an OAW-IAP makes the port available as a downlink wired bridge and allows client access through the port.



When using 3G uplink, the wired port will be used as downlink.

You can configure support for wired bridging on the Ethernet 0 port of an OAW-IAP using the AOS-W Instant UI or CLI.

In the AOS-W Instant UI

To configure Ethernet bridging:

1. On the **Access Points** tab, click the OAW-IAP to modify. The **edit** link is displayed.
2. Click the **edit** link. The **edit** window for modifying OAW-IAP details is displayed.
3. Click the **Uplink** tab.
4. Select **Enable** from the **Eth0 Bridging** drop-down list.
5. Click **OK**.
6. Reboot the OAW-IAP.

In the CLI

To configure Ethernet bridging:

```
Instant Access Point# enet0-bridging
```



Make the necessary changes to the wired-profile when eth0 is used as the downlink port. For more information, see the [Configuring a Wired Profile](#) on page 115

This chapter provides the following information:

- [Layer-3 Mobility Overview](#) on page 342
- [Configuring L3-Mobility](#) on page 343

Layer-3 Mobility Overview

OAW-IAPs form a single AOS-W Instant network when they are in the same Layer-2 (L2) domain. As the number of clients increase, multiple subnets are required to avoid broadcast overhead. In such a scenario, a client must be allowed to roam away from the AOS-W Instant network to which it first connected (home network) to another network supporting the same WLAN access parameters (foreign network) and continue its existing sessions.

Layer-3 (L3) mobility allows a client to roam without losing its IP address and sessions. If WLAN access parameters are the same across these networks, clients connected to OAW-IAPs in a given AOS-W Instant network can roam to APs in a foreign AOS-W Instant network and continue their existing sessions. Clients roaming across these networks are able to continue using their IP addresses after roaming. You can configure a list of Virtual Controller IP addresses across which L3 mobility is supported.

The AOS-W Instant Layer-3 mobility solution defines a Mobility Domain as a set of Instant networks, with the same WLAN access parameters, across which client roaming is supported. The AOS-W Instant network to which the client first connects is called its home network. When the client roams to a foreign network, an AP in the home network (home AP) anchors all traffic to or from this client. The AP to which the client is connected in the foreign network (foreign AP) tunnels all client traffic to or from the home AP through a GRE tunnel.

Figure 99 Routing of traffic when the client is away from its home network

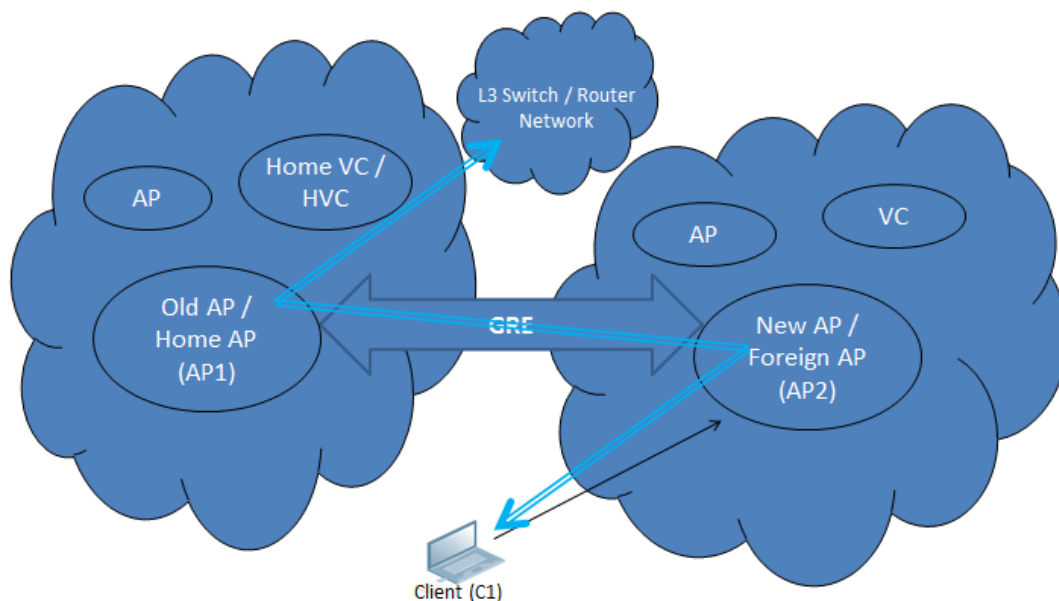

When a client first connects to an AOS-W Instant network, a message is sent to all configured Virtual Controller IP addresses to see if this is an L3 roamed client. On receiving an acknowledgement from any of the configured Virtual Controller IP addresses, the client is identified as an L3 roamed client. If the AP has no GRE tunnel to this home network, a new tunnel is formed to an AP (home AP) from the client's home network.

Each foreign AP has only one home AP per AOS-W Instant network to avoid duplication of broadcast traffic. Separate GRE tunnels are created for each foreign AP / home AP pair. If a peer AP is a foreign AP for one client and a home AP for another, two separate GRE tunnels are used to handle L3 roaming traffic between these APs.

If client subnet discovery fails on association due to some reason, the foreign AP identifies its subnet when it sends out the first L3 packet. If the subnet is not a local subnet and belongs to another Instant network, the client is treated as an L3 roamed client and all its traffic is forwarded to the home network through a GRE tunnel.

Configuring L3-Mobility

To configure a mobility domain, you have to specify the list of all AOS-W Instant networks that form the mobility domain. To allow clients to roam seamlessly among all the APs, specify the Virtual Controller IP for each foreign subnet. You may include the local Instant or Virtual Controller IP address, so that the same configuration can be used across all AOS-W Instant networks in the mobility domain.

It is recommended that you configure all client subnets in the mobility domain. When client subnets are configured:

- If a client is from a local subnet, it is identified as a local client. When a local client starts using the IP address, the L3 roaming is terminated.
- If the client is from a foreign subnet, it is identified as a foreign client. When a foreign client starts using the IP address, the L3 roaming is set up.

Home Agent Load Balancing

Home Agent Load Balancing is required in large networks where multiple tunnels might terminate on a single border or lobby AP and overload it. When load balancing is enabled, the Virtual Controller assigns the home AP for roamed clients by using a *round robin* policy. With this policy, the load for the APs acting as Home Agents for roamed clients is uniformly distributed across the OAW-IAP cluster.

Configuring a Mobility Domain for AOS-W Instant

You can configure L3 mobility domain by using the AOS-W Instant UI or CLI.

In the AOS-W Instant UI

To configure a mobility domain, perform the following steps:

1. Click the **System** link at top right corner of the AOS-W Instant main window. The **System** window is displayed.
2. Click the **Show advanced options** link. The advanced options are displayed.
3. Click **L3 Mobility**. The L3 Mobility window is displayed.

Figure 100 L3 Mobility Window

Home agent load balancing:

Virtual Controller IP Addresses

IP address	Subnet mask	VLAN ID	Virtual controller IP
------------	-------------	---------	-----------------------

New Edit Delete

Subnets

IP address	Subnet mask	VLAN ID	Virtual controller IP
------------	-------------	---------	-----------------------

New Edit Delete

4. Select **Enabled** from the **Home agent load balancing** drop-down list. By default, home agent load balancing is disabled.
5. Click **New** in the **Virtual Controller IP Addresses** section, add the IP address of a Virtual Controller that is part of the mobility domain, and click **OK**.
6. Repeat Step 2 to add the IP addresses of all Virtual Controllers that form the L3 mobility domain.
7. Click **New** in the **Subnets** section and specify the following:
 - a. Enter the client subnet in the **IP address** text box.
 - b. Enter the mask in the **Subnet mask** text box.
 - c. Enter the VLAN ID in the home network in the **VLAN ID** text box.
 - d. Enter the home VC IP address for this subnet in the **Virtual Controller IP** text box.
8. Click **OK**.

In the CLI

To configure a mobility domain:

```
(Instant AP) (config)# l3-mobility
(Instant AP) (L3-mobility)# home-agent-load-balancing
(Instant AP) (L3-mobility)# virtual-controller <IP-address>
(Instant AP) (L3-mobility)# subnet <IP-address> <subnet-mask> <VLAN-ID> <virtual-controller-IP-address>
(Instant AP) (L3-mobility)# end
(Instant AP)# commit apply
```

This chapter provides the following information:

- [Understanding Spectrum Data on page 345](#)
- [Configuring Spectrum Monitors and Hybrid OAW-IAPs on page 351](#)

Understanding Spectrum Data

Wireless networks operate in environments with electrical and radio frequency devices that can interfere with network communications. Microwave ovens, cordless phones, and even adjacent Wi-Fi networks are all potential sources of continuous or intermittent interference. The spectrum monitor software modules on OAW-IAPs that support this feature are able to examine the radio frequency (RF) environment in which the Wi-Fi network is operating, identify interference and classify its sources. An analysis of the results can then be used to quickly isolate issues with packet transmission, channel quality, and traffic congestion caused by contention with other devices operating in the same band or channel.

Spectrum monitors (SMs) are OAW-IAP radios that gather spectrum data but do not service clients. Each SM scans and analyzes the spectrum band used by the SM's radio (2.4 GHz or 5 GHz). An AP radio in hybrid AP mode continues to serve clients as an access point while it analyzes spectrum analysis data for the channel the radio uses to serve clients. You can record data for both types of spectrum monitor devices. However, the recorded spectrum is not reported to the Virtual Controller. A spectrum alert is sent to the VC when a non Wi-Fi interference device is detected.

The spectrum monitor is fully supported on all OAW-IAPs/ OAW-IAPs with a few exceptions:

- OAW-RAP155 does not support Spectrum from 6.3.1.1-4.0.0.0 release.
- OAW-IAP105 supports the dedicated Spectrum mode, but not the Hybrid Spectrum mode.
- OAW-IAP3 do not support Spectrum display in the AOS-W InstantUI.

The spectrum data is collected by each OAW-IAP spectrum monitor and hybrid AP. The spectrum data is not reported to the Virtual Controller. The **Spectrum** link is visible in the UI (Access Point view) only if you have enabled the spectrum monitoring feature. You can view the following spectrum data in the UI:

- [Device List](#)
- [Non Wi-Fi Interferers](#)
- [Channel Metrics](#)
- [Channel Details](#)
- [Spectrum Alerts](#)

Device List

The device list consists of a device summary table and channel information for active non Wi-Fi devices currently seen by a spectrum monitor or hybrid AP radio.

To view the device list, click **Spectrum** in the dashboard. The following figure shows an example of the device list details.

Figure 101 *Device List*

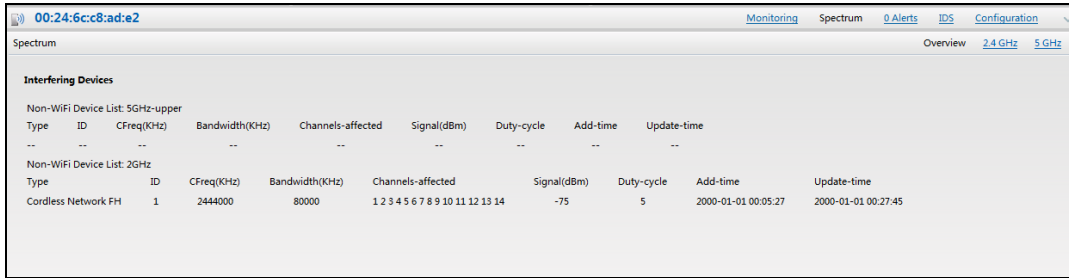

[Device Summary and Channel Information](#) shows the details of the information that is displayed:

Table 67: *Device Summary and Channel Information*

Column	Description
Type	<p>Device type. This parameter can be any of the following:</p> <ul style="list-style-type: none"> • audio FF (fixed frequency) • bluetooth • cordless base FH (frequency hopper) • cordless phone FF (fixed frequency) • cordless network FH (frequency hopper) • generic FF (fixed frequency) • generic FH (frequency hopper) • generic interferer • microwave • microwave inverter • video • xbox <p>NOTE: For additional details about non Wi-Fi device types shown in this table, see Non Wi-Fi Interferer Types.</p>
ID	ID number assigned to the device by the spectrum monitor or hybrid AP radio. Spectrum monitors and hybrid APs assign a unique spectrum ID per device type.
Cfreq	Center frequency of the signal sent from the device.
Bandwidth	Channel bandwidth used by the device.
Channels-affected	Radio channels affected by the wireless device.
Signal-strength	Strength of the signal sent from the device, in dBm.

Column	Description
Duty-cycle	Device duty cycle. This value represents the percent of time the device broadcasts a signal.
Add-time	Time at which the device was first detected.
Update-time	Time at which the device's status was updated.

Non Wi-Fi Interferers

The following table describes each type of non Wi-Fi interferer detected by the spectrum monitor feature.

Table 68: *Non Wi-Fi Interferer Types*

Non Wi-Fi Interferer	Description
Bluetooth	Any device that uses the Bluetooth protocol to communicate in the 2.4 GHz band is classified as a <i>Bluetooth</i> device. Bluetooth uses a frequency hopping protocol.
Fixed Frequency (Audio)	Some audio devices such as wireless speakers and microphones also use fixed frequency to continuously transmit audio. These devices are classified as <i>Fixed Frequency (Audio)</i> .
Fixed Frequency (Cordless Phones)	Some cordless phones use a fixed frequency to transmit data (much like the fixed frequency video devices). These devices are classified as <i>Fixed Frequency (Cordless Phones)</i> .
Fixed Frequency (Video)	Video transmitters that continuously transmit video on a single frequency are classified as <i>Fixed Frequency (Video)</i> . These devices typically have close to a 100% duty cycle. These types of devices may be used for video surveillance, TV or other video distribution, and similar applications.
Fixed Frequency (Other)	All other fixed frequency devices that do not fall into one of the above categories are classified as <i>Fixed Frequency (Other)</i> . Note that the RF signatures of the fixed frequency audio, video and cordless phone devices are very similar and that some of these devices may be occasionally classified as <i>Fixed Frequency (Other)</i> .
Frequency Hopper (Cordless Base)	Frequency hopping cordless phone base units transmit periodic beacon-like frames at all times. When the handsets are not transmitting (i.e., no active phone calls), the cordless base is classified as <i>Frequency Hopper (Cordless Bas)</i> .
Frequency Hopper (Cordless Network)	When there is an active phone call and one or more handsets are part of the phone conversation, the device is classified as <i>Frequency Hopper (Cordless Network)</i> . Cordless phones may operate in 2.4 GHz or 5 GHz bands. Some phones use both 2.4 GHz and 5 GHz bands (for example, 5 GHz for Base-to-handset and 2.4 GHz for Handset-to-base). These phones may be classified as unique Frequency Hopper devices on both bands.

Non Wi-Fi Interferer	Description
Frequency Hopper (Xbox)	The Microsoft Xbox device uses a frequency hopping protocol in the 2.4 GHz band. These devices are classified as <i>Frequency Hopper (Xbox)</i> .
Frequency Hopper (Other)	When the classifier detects a frequency hopper that does not fall into one of the above categories, it is classified as <i>Frequency Hopper (Other)</i> . Some examples include IEEE 802.11 FHSS devices, game consoles and cordless/hands-free devices that do not use one of the known cordless phone protocols.
Microwave	Common residential microwave ovens with a single magnetron are classified as a <i>Microwave</i> . These types of microwave ovens may be used in cafeterias, break rooms, dormitories and similar environments. Some industrial, healthcare or manufacturing environments may also have other equipment that behave like a microwave and may also be classified as a Microwave device.
Microwave (Inverter)	Some newer-model microwave ovens have the inverter technology to control the power output and these microwave ovens may have a duty cycle close to 100%. These microwave ovens are classified as <i>Microwave (Inverter)</i> . Dual-magnetron industrial microwave ovens with higher duty cycle may also be classified as Microwave (Inverter). There may be other equipment that behaves like inverter microwaves in some industrial, healthcare or manufacturing environments. Those devices may also be classified as Microwave (Inverter).
Generic Interferer	Any non-frequency hopping device that does not fall into one of the other categories described in this table is classified as a <i>Generic Interferer</i> . For example a Microwave-like device that does not operate in the known operating frequencies used by the Microwave ovens may be classified as a Generic Interferer. Similarly wide-band interfering devices may be classified as Generic Interferers.

Channel Details

When you move your mouse over a channel, the channel details or the summary of the 5 GHz and 2.4 GHz channels as detected by a spectrum monitor are displayed. You can view the aggregate data for each channel seen by the spectrum monitor radio, including the maximum AP power, interference and the signal-to-noise-and-interference Ratio (SNIR). SNIR is the ratio of signal strength to the combined levels of interference and noise on that channel. Spectrum monitors display spectrum data seen on all channels in the selected band, and hybrid APs display data from the one channel they are monitoring.

Figure 102 Channel Details

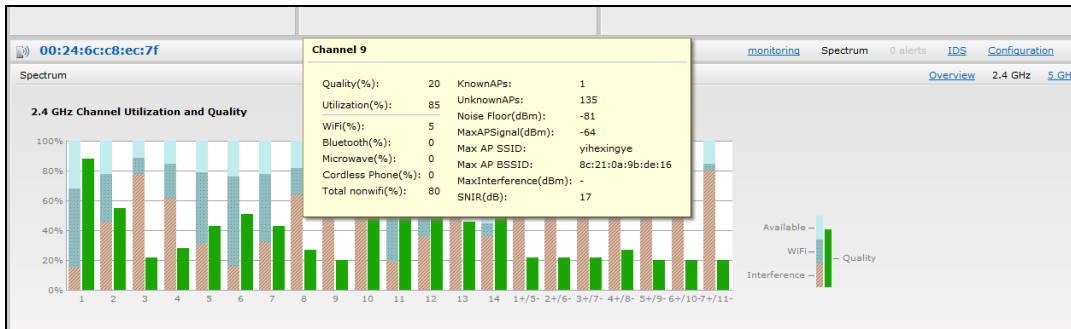

Channel Details Information shows the information that you can view in the channel details graph.

Table 69: Channel Details Information

Column	Description
Channel	An 802.11a or 802.11g radio channel.
Quality(%)	Current relative quality of the channel.
Utilization(%)	The percentage of the channel being used.
Wi-Fi (%)	The percentage of the channel currently being used by Wi-Fi devices.
Type	Device type.
Total nonwifi (%)	The percentage of the channel currently being used by non Wi-Fi devices.
Known APs	Number of valid APs identified on the radio channel.
UnKnown APs	Number of invalid or rogue APs identified on the radio channel.
Channel Util (%)	Percentage of the channel currently in use.
Max AP Signal (dBm)	Signal strength of the AP that has the maximum signal strength on a channel.
Max Interference (dBm)	Signal strength of the non Wi-Fi device that has the highest signal strength.
SNIR (db)	The ratio of signal strength to the combined levels of interference and noise on that channel. This value is calculated by determining the maximum noise-floor and interference-signal levels, and then calculating how strong the desired signal is above this maximum.

Channel Metrics

The channel metrics graph displays channel quality, availability and utilization metrics as seen by a spectrum monitor or hybrid AP. You can view the channel utilization data for the percentage of each channel that is currently being used by Wi-Fi devices, and the percentage of each channel being used by non Wi-Fi devices and 802.11 adjacent channel interference (ACI). This chart shows the channel availability, the percentage of each channel that is available for use, or the current relative quality of selected channels in the 2.4 GHz or 5 GHz radio bands. While spectrum monitors can display data for all channels in their selected band, hybrid APs display data for their one monitored channel only.

To view this graph, click **2.4 GHz** in the **Spectrum** section of the dashboard.

Figure 103 Channel Metrics for the 2.4 GHz Radio Channel

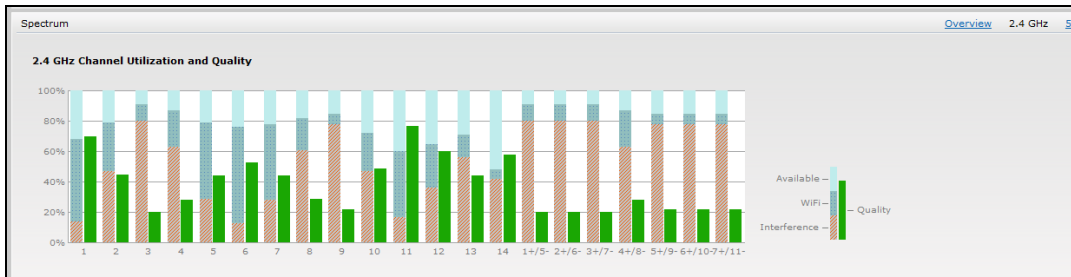

To view this graph, click **5 GHz** in the **Spectrum** section of the dashboard.

Figure 104 Channel Metrics for the 5 GHz Radio Channel

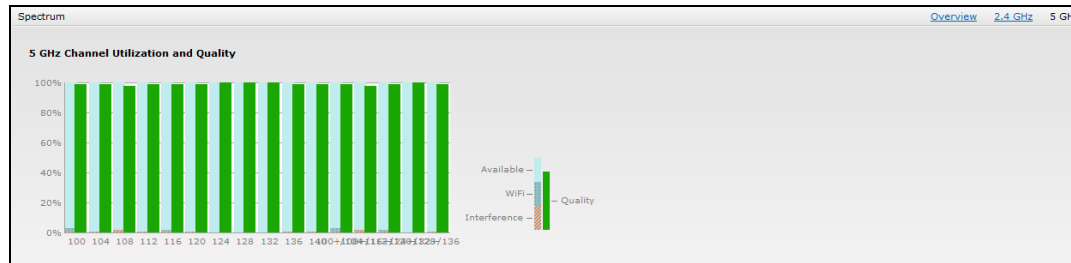

Channel Metrics shows the information displayed in the channel metrics graph.

Table 70: Channel Metrics

Column	Description
Channel	A 2.4 GHz or 5 GHz radio channel.
Quality(%)	Current relative quality of selected channels in the 2.4 GHz or 5 GHz radio bands, as determined by the percentage of packet retries, the current noise floor, and the duty cycle for non Wi-Fi devices on that channel.
Availability(%)	The percentage of the channel currently available for use.
Utilization(%)	The percentage of the channel being used.
WiFi Util(%)	The percentage of the channel currently being used by Wi-Fi devices.
Interference Util(%)	The percentage of the channel currently being used by non Wi-Fi interference + Wi-Fi ACI (Adjacent Channel Interference)

Spectrum Alerts

When a new non Wi-Fi device is found, an alert is reported to the Virtual Controller. The spectrum alert messages include the device ID, device type, IP address of the spectrum monitor or hybrid AP, and the timestamp. Virtual Controller reports the detailed device information to AMP.

Configuring Spectrum Monitors and Hybrid OAW-IAPs

An OAW-IAP can be provisioned to function as a spectrum monitor or as a hybrid OAW-IAP. The radios on groups of APs can be converted to dedicated spectrum monitors or hybrid APs via the AP group's 802.11a and 802.11g radio profiles.

Converting an OAW-IAP to a Hybrid OAW-IAP

You can convert all OAW-IAPs in an AOS-W Instant network into hybrid OAW-IAPs by selecting the **Background spectrum monitoring** option in the 802.11a and 802.11g radio profiles of an OAW-IAP. APs in **Access** mode continue to provide normal access service to clients, while providing the additional function of monitoring RF interference. If any OAW-IAP in the AOS-W Instant network does not support the spectrum monitoring feature, that AP continues to function as a standard OAW-IAP, rather than a hybrid OAW-IAP. By default, the background spectrum monitoring option is disabled.

In the hybrid mode, spectrum monitoring is performed only on the home channel. In other words, if the ap-channel width is 80Mhz, spectrum monitoring is performed for 80mhz. If the channel width is 40, spectrum monitoring is performed for 40Mhz channel. In a dedicated air monitor mode, APs perform spectrum monitoring on all channels.

You can convert OAW-IAPs in an AOS-W Instant network to hybrid mode using the AOS-W Instant UI or CLI.

In the AOS-W Instant UI

To convert an OAW-IAP to a hybrid OAW-IAP:

1. Click the **RF** link at the top right corner of the AOS-W Instant UI.
2. Click **Show advanced options** to view the **Radio** tab.
3. To enable a spectrum monitor on the 802.11g radio band, in the 2.4 GHz radio profile, select **Enabled** from the **Background Spectrum Monitoring** drop-down list.
4. To enable a spectrum monitor on the 802.11a radio band, in the 5 GHz radio profile, select **Enabled** from the **Background Spectrum Monitoring** drop-down list.
5. Click **OK**.

In the CLI

To configure 2.4 GHz radio settings:

```
(Instant AP) (config)# rf dot11g-radio-profile  
(Instant AP) (RF dot11 g Radio Profile)# spectrum-monitor
```

To configure 5 GHz radio settings:

```
(Instant AP) (config)# rf dot11a-radio-profile  
(Instant AP) (RF dot11a Radio Profile)# spectrum-monitor
```

Converting an OAW-IAP to a Spectrum Monitor

In spectrum mode, spectrum monitoring is performed on entire bands and the AP functions as a dedicated full-spectrum RF monitor, scanning all channels to detect interference, whether from the neighboring APs or from non-WiFi devices such as microwaves and cordless phones.

By default, spectrum monitoring is performed on a higher band of the 5 GHz radio.

You can configure an OAW-IAP to function as a standalone spectrum monitor using the AOS-W Instant UI or CLI.

In the AOS-W Instant UI

To convert an OAW-IAP to a spectrum monitor:

1. In the **Access Points** tab, click the AP that you want to convert to a spectrum monitor. The **edit** link is displayed.
2. Click the **edit** link. The **Edit Access Point** window is displayed.
3. Click the **Radio** tab.
4. From the **Access Mode** drop-down list, select **Spectrum Monitor**.
5. Click **OK**.
6. Reboot the OAW-IAP for the changes to affect.
7. To enable spectrum monitoring for any other band for the 5 GHz radio:
 - a. Click the **RF** link at the upper right corner of the AOS-W Instant UI.
 - b. Click **Show advanced options** to view the **Radio** tab.
 - c. For the 5 GHz radio, specify the spectrum band you want that radio to monitor by selecting **Lower**, **Middle**, or **Higher** from the **Standalone spectrum band** drop-down list.
 - d. Click **OK**.

In the CLI

To convert an OAW-IAP to a spectrum monitor:

```
(Instant AP) # wifi0-mode {<access>|<monitor>|<spectrum-monitor>}
(Instant AP) # wifi1-mode {<access>|<monitor>|<spectrum-monitor>}
```

To enable spectrum monitoring for any other band for the 5 GHz radio:

```
(Instant AP) (config) # rf dot11a-radio-profile
Instant Access Point (RF dot11a Radio Profile) # spectrum-band <type>
```

To view the radio configuration:

```
Instant Access Point# show radio config
2.4 GHz:
Legacy Mode:disable
Beacon Interval:100
802.11d/802.11h:disable
Interference Immunity Level:2
Channel Switch Announcement Count:0
Channel Reuse Type:disable
Channel Reuse Threshold:0
Background Spectrum Monitor:disable

5.0 GHz:
Legacy Mode:disable
Beacon Interval:100
802.11d/802.11h:disable
Interference Immunity Level:2
Channel Switch Announcement Count:0
Channel Reuse Type:disable
Channel Reuse Threshold:0
Background Spectrum Monitor:disable
Standalone Spectrum Band:5ghz-upper
```

This section provides information on the following procedures:

- [Upgrading an OAW-IAP on page 353](#)
- [Backing up and Restoring OAW-IAP Configuration Data on page 356](#)
- [Converting an OAW-IAP to a Remote AP and Campus AP on page 357](#)
- [Resetting a Remote AP or Campus AP to an OAW-IAP on page 363](#)
- [Rebooting the OAW-IAP on page 363](#)

Upgrading an OAW-IAP

While upgrading an OAW-IAP, you can use the image check feature to allow the OAW-IAP to find new software image versions available on a cloud-based image server hosted and maintained by Alcatel-Lucent. The location of the image server is fixed and cannot be changed by the user. The image server is loaded with latest versions of AOS-W Instant software.

Upgrading an OAW-IAP and Image Server

AOS-W Instant supports mixed AP-class instant deployment with all APs as part of the same Virtual Controller cluster.

Image Management Using OmniVista

If the multi-class OAW-IAP network is managed by OmniVista, image upgrades can only be done through the OmniVista UI. The OAW-IAP images for different classes must be uploaded on the AMP server. When new OAW-IAPs joining the network need to synchronize their software with the version running on the Virtual Controller, and if the new OAW-IAP belongs to a different class, the image file for the new OAW-IAP is provided by OmniVista. If OmniVista does not have the appropriate image file, the new AP will not be able to join the network.



The Virtual Controller communicates with the OmniVista server if OmniVista is configured. If OmniVista is not configured on the OAW-IAP, the image is requested from the Image server.

Image Management Using Cloud Server

If the multi-class OAW-IAP network is not managed by OmniVista, image upgrades can be done through the cloud-based image check feature. When a new OAW-IAP joining the network needs to synchronize its software version with the version on the Virtual Controller and if the new OAW-IAP belongs to a different class, the image file for the new OAW-IAP is provided by the cloud server.

Configuring HTTP Proxy on an OAW-IAP

If your network requires a proxy server for internet access, ensure that you configure the HTTP proxy on the OAW-IAP to download the image from the cloud server. After setting up the HTTP proxy settings, the OAW-IAP connects to the Activate server, OmniVista Management platform or OpenDNS server through a secure HTTP connection. You can also exempt certain applications from using the HTTP proxy (configured on an OAW-IAP) by providing their hostname or IP address under exceptions.

In the AOS-W Instant UI

Perform the following steps to configure the HTTP proxy settings:

1. Navigate to **System > Proxy**. The **Proxy** configuration window is displayed.

Figure 105 Proxy Configuration Window

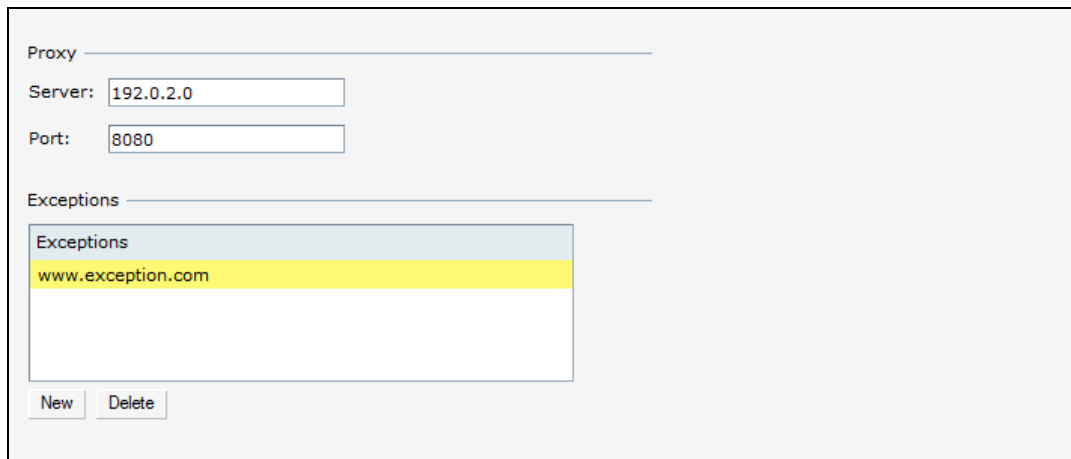

Proxy

Server:

Port:

Exceptions

Exceptions
www.exception.com

2. Enter the HTTP proxy server IP address and the port number.
3. If you do not want the HTTP proxy to be applied for a particular host, click **New** to enter that IP address or domain name of that host under exceptions list.

In the CLI

```
(Instant AP) (config)# proxy server 192.0.2.1 8080
(Instant AP) (config)# proxy exception 192.0.2.2
(Instant AP) (config)# end
(Instant AP)# commit apply
```

Upgrading an OAW-IAP Using Automatic Image Check

You can upgrade an OAW-IAP by using the automatic image check feature. The automatic image checks are performed once after the AP boots up and every week thereafter.

If the image check locates a new version of the AOS-W Instant software on the image server, the **New version available** link is displayed at the top right corner of the UI.



If OmniVista is configured, the automatic image check is disabled.

To check for a new version on the image server in the cloud:

1. Go to **Maintenance>Automatic>Check for New Version**. After the image check is completed, one of the following messages is displayed:
 - No new version available—If there is no new version available.
 - Image server timed out—Connection or session between the image server and the OAW-IAP is timed out.
 - Image server failure—If the image server does not respond.
 - A new image version found—If a new image version is found.
2. If a new version is found, the **Upgrade Now** button becomes available and the version number is displayed.
3. Click **Upgrade Now**.

The OAW-IAP downloads the image from the server, saves it to flash and reboots. Depending on the progress and success of the upgrade, one of the following messages is displayed:

- Upgrading—While image upgrading is in progress.
- Upgrade successful—When the upgrading is successful.
- Upgrade failed—When the upgrading fails.

If the upgrade fails and an error message is displayed, retry upgrading the OAW-IAP.

Upgrading to a New Version Manually

If the automatic image check feature is disabled, you can use obtain an image file from a local file system or from a TFTP or HTTP URL. To manually check for a new firmware image version and obtain an image file:

1. Navigate to **Maintenance>Firmware**. The Firmware window is displayed.
2. Under **Manual** section, perform the following steps:
 - Select the **Image file** option. This method is only available for single-class OAW-IAPs. The following examples describe the image file format for different OAW-IAP models:
 - For OAW-IAP134/135—AlcatelInstant_Cassiopeia_6.4.4.4-4.2.3.0.0_xxxx
 - For OAW-RAP108/109, OAW-IAP103, and OAW-IAP114/115—AlcatelInstant_Pegasus_6.4.4.4-4.2.3.0.0_xxxx
 - For OAW-RAP155/155P—AlcatelInstant_Aries_6.4.4.4-4.2.3.0.0_xxxx
 - For OAW-IAP224/225, OAW-IAP228, OAW-IAP214/215, OAW-IAP274/275, OAW-IAP277—AlcatelInstant_Centaurus_6.4.4.4-4.2.3.0.0_xxxx
 - For IAP-324/325—AlcatelInstant_Hercules_6.4.4.4-4.2.3.0.0_xxxx
 - For OAW-IAP204/205 and OAW-IAP205H—AlcatelInstant_Taurus_6.4.4.4-4.2.3.0.0_xxxx
 - For all other OAW-IAPs—AlcatelInstant_Orion_6.4.4.4-4.2.3.0.0_xxxx
 - Select the **Image URL** option. Select this option to obtain an image file from a TFTP, FTP, or HTTP URL.
 - HTTP - http://<IP-address>/<image-file>. For example, http://<IP-address>/AlcatelInstant_Orion_6.4.4.4-4.2.3.0.0_xxxx
 - TFTP - tftp://<IP-address>/<image-file>. For example, tftp://<IP-address>/AlcatelInstant_Orion_6.4.4.4-4.2.3.0.0_xxxx
 - FTP - ftp://<IP-address>/<image-file>. For example, ftp://<IP-address>/AlcatelInstant_Orion_6.4.4.4-4.2.3.0.0_xxxx
3. Clear the **Reboot all APs after upgrade** checkbox if required. The **Reboot all APs after upgrade** checkbox is selected by default to allow the OAW-IAPs to reboot automatically after a successful upgrade. To reboot the OAW-IAP at a later time, clear the **Reboot all APs after upgrade** checkbox.
4. Click **Upgrade Now** to upgrade the OAW-IAP to the newer version.

Upgrading an Image Using CLI

To upgrade an image using a HTTP, TFTP, or FTP URL:

```
(Instant AP)# upgrade-image <ftp/tftp/http-URL>
```

To upgrade an image without rebooting the OAW-IAP:

```
(Instant AP)# upgrade-image2-no-reboot <ftp/tftp/http-URL>
```

To view the upgrade information:

```
(Instant AP)# show upgrade info
```

```
Image Upgrade Progress
-----
Mac IP Address AP Class Status Image Info Error Detail
```

```
-----  
d8:c7:c8:c4:42:98 10.17.101.1 Orion image-ok image file none  
Auto reboot :enable  
Use external URL :disable
```

Backing up and Restoring OAW-IAP Configuration Data

You can back up the OAW-IAP configuration data and restore the configuration when required.

Viewing Current Configuration

To view the current configuration on the OAW-IAP:

- In the UI, navigate to **Maintenance > Configuration > Current Configuration**.
- In the CLI, enter the following command at the command prompt:

```
(Instant AP)# show running-config
```

Backing up Configuration Data

To back up the OAW-IAP configuration data:

1. Navigate to the **Maintenance > Configuration>** page.
2. Click **Backup Configuration**.
3. Click **Continue** to confirm the backup. The *instant.cfg* containing the OAW-IAP configuration data is saved in your local file system.
4. To view the configuration that is backed up by the OAW-IAP, enter the following command at the command prompt:

```
(Instant AP)# show backup-config
```

Restoring Configuration

To restore configuration:

1. Navigate to the **Maintenance > Configuration** page.
2. Click **Restore Configuration**. Click **Browse** to browse your local system and select the configuration file.
3. Click **Restore Now**.
4. Click **Restore Configuration** to confirm restoration. The configuration is restored and the OAW-IAP reboots to load the new configuration.

Converting an OAW-IAP to a Remote AP and Campus AP

This section provides the following information:

- [Regulatory Domain Restrictions for OAW-IAP to RAP or CAP Conversion on page 357](#)
- [Converting an OAW-IAP to a Remote AP on page 359](#)
- [Converting an OAW-IAP to a Campus AP on page 361](#)
- [Converting an OAW-IAP to Standalone Mode on page 362](#)
- [Converting an OAW-IAP using CLI on page 363](#)

Regulatory Domain Restrictions for OAW-IAP to RAP or CAP Conversion

You can provision an OAW-IAP as a Campus AP or a Remote AP in a switch-based network. Before converting an OAW-IAP, ensure that there is a regulatory domain match between the OAW-IAP and switch.

The following table describes the regulatory domain restrictions that apply for the OAW-IAP to AOS-W Instant OAW-AP conversion:

Table 71: OAW-IAP to AOS-W Instant Conversion

OAW-IAP Variant	OAW-IAP Regulatory Domain	Switch Regulatory Domain			AOS-W Instant version
		US	Unrestricted	IS	
OAW-IAP277	US	Y	X	X	6.4.3.0 or later
	RW	X	Y	Y	
	JP	X	Y	X	
OAW-IAP228	US	Y	X	X	6.4.3.0 or later
	RW	X	Y	Y	
	JP	X	Y	X	
OAW-IAP205H	US	Y	X	X	6.4.3.0 or later
	RW	X	Y	Y	
	JP	X	Y	X	
	IS	X	X	Y	
OAW-IAP21x	US	Y	X	X	6.4.2.0 or later
	RW	X	Y	Y	
	JP	X	Y	X	
	IS	X	X	Y	

Table 71: OAW-IAP to AOS-W Instant Conversion

OAW-IAP Variant	OAW-IAP Regulatory Domain	Switch Regulatory Domain			AOS-W Instant version
		US	Unrestricted	IS	
OAW-IAP205	US	Y	X	X	6.4.1.0 or later
	RW	X	Y	Y	
	JP	X	Y	X	
	IS	X	X	Y	
OAW-IAP274/275	US	Y	X	X	6.4 or later
	RW	X	Y	Y	
	JP	X	Y	X	
	IS	X	X	Y	
OAW-IAP103H	US	Y	X	X	6.4 or later
	RW	X	Y	Y	
	JP	X	Y	X	
	IS	X	X	Y	
OAW-IAP114/115	US	Y	X	X	6.3.1.3 or later
	JP	X	Y	X	
	IS	X	X	Y	
OAW-IAP22x	US	Y	X	X	6.3.1.3 or later
	RW	X	Y	Y	
	JP	X	Y	X	
	IS	X	X	Y	
OAW-IAP11x and OAW-IAP22x	US	Y	X	X	6.3.1.0, 6.3.1.1, and 6.3.1.2
	RW	X	X	X	
	JP	X	Y	X	
	IS	X	X	Y	

Table 71: OAW-IAP to AOS-W Instant Conversion

OAW-IAP Variant	OAW-IAP Regulatory Domain	Switch Regulatory Domain			AOS-W Instant version
		US	Unrestricted	IS	
OAW-IAP22x	US	Y	X	X	6.3
	RW/JP/IS	X	X	X	
All other OAW-IAPs	US	Y	X	X	Versions lower than 6.3.0, 6.3, 6.3.x.x, 6.4, and 6.4.x.x
	Unrestricted	X	Y	X	
	IS	X	X	Y	
	JP	X	Y	X	

Converting an OAW-IAP to a Remote AP

For Remote AP conversion, the Virtual Controller sends the Remote AP convert command to all the other OAW-IAPs. The Virtual Controller along with the other slave OAW-IAPs set up a VPN tunnel to the remote switch, and download the firmware through FTP. The Virtual Controller uses IPsec to communicate to the OmniAccess WLAN Switch over the Internet.

- If the OAW-IAP obtains OmniVista information through DHCP (Option 43 and Option 60), it establishes an HTTPS connection to the OmniVista server and downloads the configuration and operates in the OAW-IAP mode.
- If the OAW-IAP does not get OmniVista information through DHCP provisioning, it tries provisioning through a firmware image server in the cloud by sending a serial number MAC address. If an entry for the OAW-IAP is present in the firmware image cloud server and is provisioned as an OAW-IAP > Remote AP, the firmware image cloud server responds with mobility switch IP address, AP group, and AP type. The OAW-IAP then contacts the switch, establishes certificate-based secure communication, and obtains configuration and image from the switch. The OAW-IAP reboots and comes up as a Remote AP. The OAW-IAP then establishes an IPSEC connection with the switch and begins operating in the Remote AP mode.
- If an OAW-IAP entry for the AP is present in the firmware image cloud server, the OAW-IAP obtains OmniVista server information from the cloud server and downloads configuration from OmniVista to operate in the OAW-IAP mode.
- If there is no response from the cloud server or AirGroup is received, the OAW-IAP comes up in AOS-W Instant mode.
- For more information on firmware image cloud server, see [Upgrading an OAW-IAP on page 353](#).



A mesh point cannot be converted to Remote AP, because mesh access points do not support VPN connection.

An OAW-IAP can be converted to a Campus AP and Remote AP only if the switch is running AOS-W Instant 6.1.4 or later.

The following table describes the supported OAW-IAP platforms and minimal AOS-W Instant version required for the Campus AP or Remote AP conversion.

Table 72: OAW-IAP Platforms and Minimum AOS-W Instant Versions for OAW-IAP to Remote AP Conversion

OAW-IAP Platform	AOS-W Instant Version	AOS-W Instant Version
OAW-IAP103	6.4 or later	4.1 or later
OAW-IAP104	6.1.4 or later	3.0 or later
OAW-IAP105	6.1.4 or later	1.0 or later
OAW-IAP134/135	6.1.4 or later	2.0 or later
OAW-IAP175AC/175P	6.1.4 or later	3.0 or later
OAW-RAP3WN/3WNP	6.1.4 or later	3.0 or later
OAW-RAP108/109	6.2.0.0 or later	3.2 or later
OAW-RAP155/155P	6.3 or later	3.3 or later
OAW-IAP114/115	6.3.1.1 or later	4.0 or later
OAW-IAP224/225	6.3.1.1 or later	4.0 or later
OAW-IAP274/275	6.4 or later	4.1 or later
OAW-IAP204/205	6.4.1.0 or later	4.1.1 or later
OAW-IAP214/215	6.4.2.0 or later	4.1.1 or later
OAW-IAP205H OAW-IAP228 OAW-IAP277	6.4.3.1 or later	4.2 or later

To convert an OAW-IAP to a RAP, perform the following steps:

1. Click the **Maintenance** link in the AOS-W Instant main window.
2. Click the **Convert** tab. The **Convert** tab contents are displayed.

Figure 106 Maintenance—Convert Tab

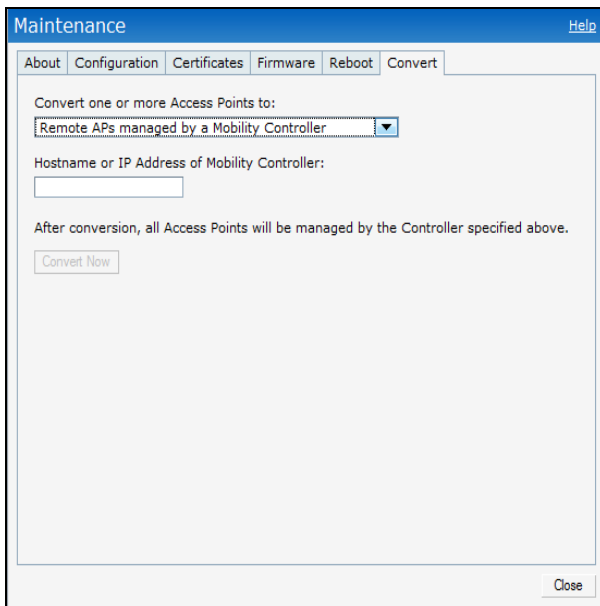

3. Select **Remote APs managed by a Mobility Controller** from the drop-down list.
4. Enter the hostname (fully qualified domain name) or the IP address of the switch in the **Hostname or IP Address of Mobility Controller** text box. Contact your local network administrator to obtain the IP address.



Ensure that the OmniAccess WLAN Switch IP Address is reachable by the an OAW-IAPs.

5. Click **Convert Now** to complete the conversion. The OAW-IAP reboots and begins operating in the Remote AP mode.
6. After conversion, the OAW-IAP is managed by the mobility switch.



For OAW-IAPs to function as Remote APs, configure the OAW-IAP in the Remote AP whitelist and enable the FTP service on the switch.



If the VPN setup fails and an error message is displayed, click **OK**, copy the error logs, and share them with your local administrator.

Converting an OAW-IAP to a Campus AP

To convert an OAW-IAP to a Campus AP, do the following:

1. Click the **Maintenance** link in the AOS-W Instant main window.
2. Click the **Convert** tab. The **Convert** tab is displayed.

Figure 107 Converting an OAW-IAP to Campus AP

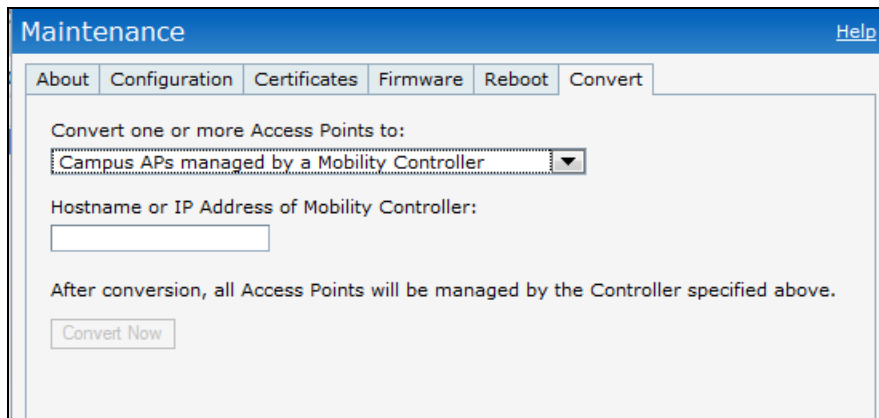

3. Select **Campus APs managed by a Mobility Controller** from the drop-down list.
4. Enter the hostname, Fully Qualified Domain Name (FQDN), or the IP address of the switch in the **Hostname or IP Address of Mobility Controller** text box. Contact your local administrator to obtain these details.
5. Ensure that the OAW-IAPs access the OmniAccess WLAN Switch IP Address.
6. Click **Convert Now** to complete the conversion.

Converting an OAW-IAP to Standalone Mode

This feature allows you to deploy an OAW-IAP as an autonomous AP, which is a separate entity from the existing Virtual Controller cluster in the Layer 2 domain.

When an OAW-IAP is converted to the standalone mode, it cannot join a cluster of OAW-IAPs even if the OAW-IAP is in the same VLAN. If the OAW-IAP is in the cluster mode, it can form a cluster with other Virtual Controller OAW-IAPs in the same VLAN.

To deploy an OAW-IAP as a standalone and autonomous AP:

1. Click the **Maintenance** link in the AOS-W Instant main window.
2. Click the **Convert** tab. The **Convert** tab is displayed.

Figure 108 Standalone AP Conversion

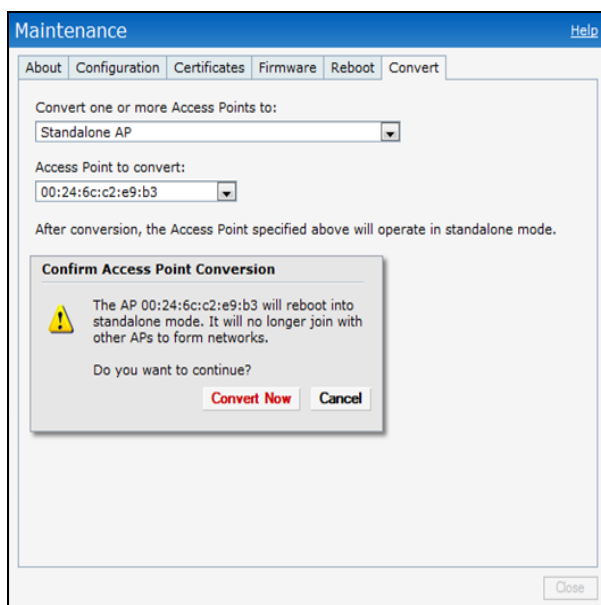

3. Select **Standalone AP** from the drop-down list.
4. Select the Access Point from the drop-down list.
5. Click **Convert Now** to complete the conversion. The an OAW-IAP now operates in the standalone mode.

Converting an OAW-IAP using CLI

To convert an OAW-IAP to a remote AP or campus AP, execute the following command:

```
(Instant AP) # convert-aos-ap <mode> <controller-IP-address>
```

To convert an OAW-IAP to a Standalone AP or to provision an OAW-IAP in the cluster mode, execute the following command:

```
(Instant AP) # swarm-mode <mode>
```

Resetting a Remote AP or Campus AP to an OAW-IAP

The reset button located on the rear of an OAW-IAP can be used to reset the OAW-IAP to factory default settings.

To reset an OAW-IAP, perform the following steps:

1. Power off the OAW-IAP.
2. Press and hold the reset button using a small and narrow object such as a paperclip.
3. Power on the OAW-IAP without releasing the reset button. The power LED flashes within 5 seconds indicating that the reset is completed.
4. Release the reset button. The OAW-IAP reboots with the factory default settings.



All APs have a reset button, except OAW-IAP-175P/175AC. Contact Alcatel-Lucent support for resetting these OAW-IAPs.

Rebooting the OAW-IAP

If you encounter any problem with the OAW-IAPs, you can reboot all OAW-IAPs or a selected OAW-IAP in a network using the AOS-W Instant UI. To reboot an OAW-IAP:

1. Click the **Maintenance** link. The **Maintenance** window is displayed.
2. Click the **Reboot** tab.

Figure 109 *Rebooting the OAW-IAP*

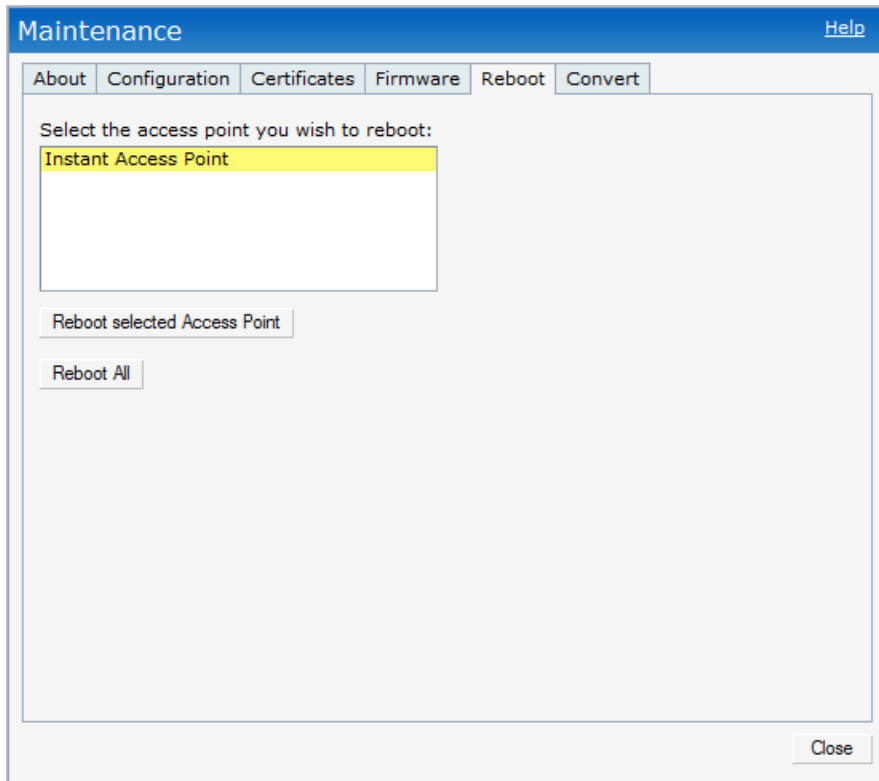

3. In the OAW-IAP list, select the OAW-IAP that you want to reboot and click **Reboot selected Access Point**. To reboot all the OAW-IAPs in the network, click **Reboot All**.
4. The **Confirm Reboot for AP** message is displayed. Click **Reboot Now** to proceed. The **Reboot in Progress** message is displayed indicating that the reboot is in progress. The **Reboot Successful** message is displayed after the process is complete. If the system fails to boot, the **Unable to contact Access Points after reboot was initiated message** is displayed.
5. Click **OK**.

This chapter provides the following information:

- [Configuring SNMP on page 365](#)
- [Configuring a Syslog Server on page 369](#)
- [Configuring TFTP Dump Server on page 371](#)
- [Running Debug Commands from the UI on page 372](#)
- [Uplink Bandwidth Monitoring on page 376](#)

Configuring SNMP

This section provides the following information:

- [SNMP Parameters for OAW-IAP on page 365](#)
- [Configuring SNMP on page 366](#)
- [Configuring SNMP Traps on page 368](#)

SNMP Parameters for OAW-IAP

AOS-W Instant supports SNMPv1, SNMPv2c, and SNMPv3 for reporting purposes only. An OAW-IAP cannot use SNMP to set values in an Alcatel-Lucent system.

You can configure the following parameters for an OAW-IAP:

Table 73: *SNMP Parameters for OAW-IAP*

Field	Description
Community Strings for SNMPV1 and SNMPV2	An SNMP Community string is a text string that acts as a password, and is used to authenticate messages sent between the Virtual Controller and the SNMP agent.
If you are using SNMPv3 to obtain values from the OAW-IAP, you can configure the following parameters:	
Name	A string representing the name of the user.
Authentication Protocol	An indication of whether messages sent on behalf of this user can be authenticated, and if so, the type of authentication protocol used. This can take one of the two values: <ul style="list-style-type: none"> • MD5— HMAC-MD5-96 Digest Authentication Protocol • SHA: HMAC-SHA-96 Digest Authentication Protocol

Field	Description
Authentication protocol password	If messages sent on behalf of this user can be authenticated, the (private) authentication key is used with the authentication protocol. This is a string password for MD5 or SHA based on the above-mentioned conditions.
Privacy protocol	An indication of whether messages sent on behalf of this user can be protected from disclosure, and if so, the type of privacy protocol which is used. This takes the value DES (CBC-DES Symmetric Encryption).
Privacy protocol password	If messages sent on behalf of this user can be encrypted/decrypted with DES, the (private) privacy key with the privacy protocol is used.

Configuring SNMP

This section describes the procedure for configuring SNMPv1, SNMPv2, and SNMPv3 community strings using the AOS-W Instant UI or CLI.

Creating community strings for SNMPv1 and SNMPv2 Using AOS-W Instant UI

To create community strings for SNMPv1 and SNMPv2:

1. Click the **System** link at the top right corner of the AOS-W Instant main window. The system window is displayed.
2. Click the **Monitoring** tab. The following figure shows the SNMP configuration parameters displayed in the **Monitoring** tab.

Figure 110 Monitoring Tab: SNMP Configuration Parameters

3. Click **New**.
4. Enter the string in the **New Community String** text box.
5. Click **OK**.
6. To delete a community string, select the string, and click **Delete**.

Creating community strings for SNMPv3 Using AOS-W Instant UI

To create community strings for SNMPv3:

1. Click **System** link at the top right corner of the AOS-W Instant main window. The system window is displayed.
2. Click the **Monitoring** tab. The SNMP configuration parameters displayed in the **Monitoring** tab.
3. Click **New** in the **Users for SNMPV3** box. A window for specifying SNMPv3 user information is displayed.

Figure 111 SNMPv3 User

4. Enter the name of the user in the **Name** text box.
5. Select the type of authentication protocol from the **Auth protocol** drop-down list.
6. Enter the authentication password in the **Password** text box and retype the password in the **Retype** text box.
7. Select the type of privacy protocol from the **Privacy protocol** drop-down list.
8. Enter the privacy protocol password in the **Password** text box and retype the password in the **Retype** text box.
9. Click **OK**.
10. To edit the details for a particular user, select the user and click **Edit**.
11. To delete a particular user, select the user and click **Delete**.

Configuring SNMP Community Strings in the CLI

To configure an SNMP engine ID and host:

```
(Instant AP) (config)# snmp-server engine-id <engine-ID>
(Instant AP) (config)# host <ipaddr> version {1 <name> udp-port <port>}|{2c|3 <name> [inform]
[udp-port <port>]}
```

To configure SNMPv1 and SNMPv2 community strings:

```
(Instant AP) (config)# snmp-server community <password>
```

To configure SNMPv3 community strings:

```
(Instant AP) (config)# snmp-server user <name> <auth-protocol> <password> <privacy-protocol>
<password>
```

To view SNMP configuration:

```
(Instant AP)# show snmp-configuration
```

```
Engine ID:D8C7C8C44298
Community Strings
-----
Name
----
SNMPv3 Users
-----
Name Authentication Type Encryption Type
-----
SNMP Trap Hosts
-----
IP Address Version Name Port Inform
-----
```

Configuring SNMP Traps

AOS-W Instant supports the configuration of external trap receivers. Only the OAW-IAP acting as the Virtual Controller generates traps. The traps for OAW-IAP cluster are generated with Virtual Controller IP as the source IP if Virtual Controller IP is configured. The OID of the traps is 1.3.6.1.4.1.14823.2.3.3.1.200.2.X.

You can configure SNMP traps using the AOS-W Instant UI or CLI.

In the AOS-W Instant UI

To configure an SNMP trap receiver:

1. Navigate to **System > Show advanced options > Monitoring**. The **Monitoring** window is displayed.

2. Under **SNMP Traps**, enter a name in the **SNMP Engine ID** text box. It indicates the name of the SNMP agent on the access point. The SNMPV3 agent has an engine ID that uniquely identifies the agent in the device and is unique to that internal network.
3. Click **New** and update the following fields:
 - **IP Address**— Enter the **IP Address** of the new SNMP Trap receiver.
 - **Version**— Select the SNMP version— **v1, v2c, v3** from the drop-down list. The version specifies the format of traps generated by the access point.
 - **Community/Username**— Specify the community string for SNMPv1 and SNMPv2c traps and a username for SNMPv3 traps.
 - **Port**— Enter the port to which the traps are sent. The default value is 162.
 - **Inform**— When enabled, traps are sent as SNMP INFORM messages. It is applicable to SNMPv3 only. The default value is **Yes**.
4. Click **OK** to view the trap receiver information in the **SNMP Trap Receivers** window.

In the CLI

To configure SNMP traps:

```
(Instant AP) (config)# snmp-server host <IP-address> {version 1 | version 2 | version 3} <name>  
udp-port <port> inform  
(Instant AP) (config)# end  
(Instant AP)# commit apply
```



AOS-W Instant supports SNMP Management Information Bases (MIBs) along with Alcatel-Lucent-MIBs. For information about MIBs and SNMP traps, see *AOS-W Instant MIB Reference Guide*.

Configuring a Syslog Server

You can specify a syslog server for sending syslog messages to the external servers either by using the AOS-W Instant UI or CLI.

In the AOS-W Instant UI

1. In the AOS-W Instant main window, click the **System** link. The **System** window is displayed.
2. Click **Show advanced options** to display the advanced options.
3. Click the **Monitoring** tab. The **Monitoring** tab details are displayed.

Figure 112 Syslog Server

4. In the **Syslog server** text box, enter the IP address of the server to which you want to send system logs.
5. Select the required values to configure syslog facility levels. Syslog Facility is an information field associated with a syslog message. It is an application or operating system component that generates a log message. The following seven facilities are supported by Syslog:
 - **AP-Debug**— Detailed log about the AP device.
 - **Network**— Log about change of network, for example, when a new OAW-IAP is added to a network.
 - **Security**— Log about network security, for example, when a client connects using wrong password.
 - **System**— Log about configuration and system status.
 - **User**— Important logs about client.
 - **User-Debug**— Detailed log about client.
 - **Wireless**— Log about radio.

The following table describes the logging levels in order of severity, from the most to the least severe.

Table 74: Logging Levels

Logging Level	Description
Emergency	Panic conditions that occur when the system becomes unusable.
Alert	Any condition requiring immediate attention and correction.
Critical	Any critical conditions such as a hard drive error.
Errors	Error conditions.

Logging Level	Description
Warning	Warning messages.
Notice	Significant events of a non-critical and normal nature. The default value for all Syslog facilities.
Informational	Messages of general interest to system users.
Debug	Messages containing information useful for debugging.

6. Click **OK**.

In the CLI

To configure a syslog server:

```
(Instant AP) (config)# syslog-server <IP-address>
```

To configure syslog facility levels:

```
(Instant AP) (config)# syslog-level <logging-level>[ap-debug |network |security |system |user |
user-debug | wireless]
(Instant AP) (config)# end
(Instant AP)# commit apply
```

To view syslog logging levels:

```
Instant Access Point# show syslog-level
```

```
Logging Level
-----
Facility Level
-----
ap-debug warn
network warn
security warn
system warn
user warn
user-debug warn
wireless error
```

Configuring TFTP Dump Server

You can configure a TFTP server for storing core dump files by using the AOS-W Instant UI or CLI.

In the AOS-W Instant UI

1. In the AOS-W Instant main window, click the **System** link. The **System** window is displayed.
2. Click **Show advanced options** to display the advanced options.
3. Click the **Monitoring** tab. The **Monitoring** tab details are displayed.
4. Enter the IP address of the TFTP server in the **TFTP Dump Server** text box.
5. Click **OK**.

In the CLI

To configure a TFTP server:

```
(Instant AP) (config)# tftp-dump-server <IP-address>
(Instant AP) (config)# end
```

```
(Instant AP)# commit apply
```

Running Debug Commands from the UI

To run the debugging commands from the UI:

1. Navigate to **More>Support** at the top right corner of the AOS-W Instant main window. The **Support** window is displayed.
2. Select the required option from the **Command** drop-down list.
3. Select **All Access Points** or **Instant Access Point(VC)** from the **Target** drop-down list.
4. Click **Run**. When you run debug commands and click **Save**, the output of all the selected commands is displayed in a single page.

The support window allows you to run commands for each access point and virtual controller in a cluster. For a complete list of commands supported in a particular release train, execute the **show support-commands** command at the OAW-IAP CLI. The output of this command displays the list of support commands that you can run through the UI and the corresponding CLI commands. For more information on these commands, see the respective command page in the AOS-W Instant CLI Reference Guide.

```
Support Commands
```

```
-----
```

```
Description
```

```
-----
```

```
Command Name
```

```
-----
```

AP Tech Support Dump	show tech-support
AP Tech Support Dump Supplemental	show tech-support supplemental
AP Provisioning Status	show activate status
AP 3G/4G Status	show cellular status
AP 802.1X Statistics	show ap debug dot1x-statistics
AP Access Rule Table	show access-rule-all
AP Inbound Firewall Rules	show inbound-firewall-rules
AP Active	show aps
AP AirGroup Cache	show airgroup cache entries
AP AirGroup CPPM Entries	show airgroup cppm entries
AP AirGroup CPPM Servers	show airgroup cppm server
AP AirGroup Debug Statistics	show airgroup debug statistics
AP AirGroup Servers	show airgroup servers verbose
AP AirGroup User	show airgroup users verbose
AP ALE Configuration	show ale config
AP ALE Status	show ale status
AP Allowed Channels	show ap allowed-channels
AP Allowed MAX-EIRP	show ap allowed-max-EIRP
AP All Supported Timezones	show clock timezone all
AP ARM Bandwidth Management	show ap arm bandwidth-management
AP ARM Channels	show arm-channels
AP ARM Configuration	show arm config
AP ARM History	show ap arm history
AP ARM Neighbors	show ap arm neighbors
AP ARM RF Summary	show ap arm rf-summary
AP ARM Scan Times	show ap arm scan-times
AP ARP Table	show arp
AP Association Table	show ap association
AP Authentication Frames	show ap debug auth-trace-buf
AP Auth-Survivability Cache	show auth-survivability cached-info
AP Auth-Survivability Debug Log	show auth-survivability debug-log
AP BSSID Table	show ap bss-table
AP Captive Portal Domains	show captive-portal-domains
AP Captive Portal Auto White List	show captive-portal auto-white-list
AP Client Match Status	show ap debug client-match
AP Client Match History	show ap client-match-history
AP Client Match Action	show ap client-match-actions

AP Client Match Live	show ap client-match-live
AP Client Match Triggers	show ap client-match-triggers
AP Client Table	show ap debug client-table
AP Client View	show ap client-view
AP Country Codes	show country-codes
AP CPU Details	show cpu details
AP CPU Utilization	show cpu
AP Crash Info	show ap debug crash-info
AP Current Time	show clock
AP Current Timezone	show clock timezone
AP Datapath ACL Table Allocation	show datapath acl-allocation
AP Datapath ACL Tables	show datapath acl-all
AP Datapath Bridge Table	show datapath bridge
AP Datapath DMO session	show datapath dmo-session
AP Datapath DMO station	show datapath dmo-station
AP Datapath Dns Id Map	show datapath dns-id-map
AP Datapath Multicast Table	show datapath mcast
AP Datapath Nat Pool	show datapath nat-pool
AP Datapath Route Table	show datapath route
AP Datapath Session Table	show datapath session
AP Datapath DPI Session Table	show datapath session dpi
AP Datapath DPI Session Table Verbose	show datapath session dpi verbose
AP Datapath Statistics	show datapath statistics
AP Datapath User Table	show datapath user
AP Datapath VLAN Table	show datapath vlan
AP DPI Debug statistics	show dpi debug statistics
AP Daylight Saving Time	show clock summer-time
AP Derivation Rules	show derivation-rules
AP Driver Configuration	show ap debug driver-config
AP Election Statistics	show election statistics
AP External Captive Portal Status	show external-captive-portal
AP Environment Variable	show ap-env
AP ESSID Table	show network
AP Flash Configuration	show ap flash-config
AP IGMP Group Table	show ip igmp
AP Interface Counters	show interface counters
AP Interface Status	show port status
AP Internal DHCP Status	show dhcp-allocation
AP IP Interface	show ip interface brief
AP IP Route Table	show ip route
AP L3 Mobility Datapath	show l3-mobility datapath
AP L3 Mobility Events log	show log l3-mobility
AP L3 Mobility Status	show l3-mobility status
AP LACP Status	show lacp status
AP Log All	show log debug
AP Log AP-Debug	show log ap-debug
AP Log Conversion	show log convert
AP Log Driver	show log driver
AP Log Kernel	show log kernel
AP Log Network	show log network
AP Log PPPd	show log pppd
AP Log Rapper	show log rapper
AP Log Rapper Counter	show log rapper-counter
AP Log Rapper Brief	show log rapper-brief
AP Log Sapd	show log sapd
AP Log Security	show log security
AP Log System	show log system
AP Log Tunnel Status Management	show log apifmgr
AP Log Upgrade	show log upgrade
AP Log User-Debug	show log user-debug
AP Log User	show log user
AP Log VPN Tunnel	show log vpn-tunnel

AP Log Wireless	show log wireless
AP Management Frames	show ap debug mgmt-frames
AP Memory Allocation State Dumps	show malloc-state-dumps
AP Memory Utilization	show memory
AP Mesh Counters	show ap mesh counters
AP Mesh Link	show ap mesh link
AP Mesh Neighbors	show ap mesh neighbours
AP Monitor Active Laser Beams	show ap monitor active-laser-beams
AP Monitor AP Table	show ap monitor ap-list
AP Monitor ARP Cache	show ap monitor ARP Cache
AP Monitor Client Table	show ap monitor sta-list
AP Monitor Containment Information	show ap monitor containment-info
AP Monitor Potential AP Table	show ap monitor pot-ap-list
AP Monitor Potential Client Table	show ap monitor pot-sta-list
AP Monitor Router	show ap monitor routers
AP Monitor Scan Information	show ap monitor scan-info
AP Monitor Status	show ap monitor status
AP Persistent Clients	show ap debug persistent-clients
AP PMK Cache	show ap pmkcache
AP PPPoE uplink debug	show pppoe debug-logs
AP PPPoE uplink status	show pppoe status
AP Processes	show process
AP Radio 0 Client Probe Report	show ap client-probe-report 0
AP Radio 0 Stats	show ap debug radio-stats 0
AP Radio 0 info	show ap debug radio-info 0
AP Radio 1 Client Probe Report	show ap client-probe-report 1
AP Radio 1 Stats	show ap debug radio-stats 1
AP Radio 1 info	show ap debug radio-info 1
AP RADIUS Statistics	show ap debug radius-statistics
AP Termination RADIUS Statistics	show ap debug radius-statistics termination
AP Shaping Table	show ap debug shaping-table
AP Sockets	show socket
AP STM Configuration	show ap debug stm-config
AP Swarm State	show swarm state
AP System Status	show ap debug system-status
AP System Summary	show summary support
AP Uplink Status	show uplink status
AP User Table	show clients
AP Valid Channels	show valid-channels
AP Version	show version
AP Virtual Beacon Report	show ap virtual-beacon-report
AP VPN Config	show vpn config
AP VPN Status	show vpn status
AP IAP-VPN Retry Counters	show vpn tunnels
AP Wired Port Settings	show wired-port-settings
AP Wired User Table	show clients wired
AP Checksum	show ap checksum
AP Spectrum AP table	show ap spectrum ap-list
AP Spectrum channel table	show ap spectrum channel-details
AP Spectrum channel metrics	show ap spectrum channel-metrics
AP Spectrum channel summary	show ap spectrum channel-summary
AP Spectrum client table	show ap spectrum client-list
AP Spectrum device duty cycle	show ap spectrum device-duty-cycle
AP Spectrum non-wifi device history	show ap spectrum device-history
AP Spectrum non-wifi device table	show ap spectrum device-list
AP Spectrum non-wifi device log	show ap spectrum device-log
AP Spectrum number of device	show ap spectrum device-summary
AP Spectrum interference-power table	show ap spectrum interference-power
AP Spectrum status	show ap spectrum status
VC 802.1x Certificate	show lxcert
VC All Certificates	show cert all
VC radsec Certificates	show radseccert

VC Captive Portal domains	show captive-portal-domains
VC About	show about
VC Active Configuration	show running-config
VC AirGroup Service	show airgroupservice
VC AirGroup Status	show airgroup status
VC Allowed AP Table	show allowed-aps
VC AMP Status	show ap debug airwave
VC AMP Current State Data	show ap debug airwave-state
VC AMP Current Stats Data	show ap debug airwave-stats
VC AMP Data Sent	show ap debug airwave-data-sent
VC AMP Events Pending	show ap debug airwave-events-pending
VC AMP Last Configuration Received	show ap debug airwave-config-received
VC AMP Single Sign-on Key	show ap debug airwave-signon-key
VC AMP Configuration Restore Status	show ap debug airwave-restore-status
VC Central Current State Data	show ap debug cloud-state
VC Central Current Stats Data	show ap debug cloud-stats
VC Central Data Sent	show ap debug cloud-data-sent
VC Central Events Pending	show ap debug cloud-events-pending
VC Central Last Configuration Received	show ap debug cloud-config-received
VC Central Single Sign-on Key	show ap debug cloud-signon-key
VC Central Configuration Restore Status	show ap debug cloud-restore-status
VC Application Services	show app-services
VC Cloud Server Status	show ap debug cloud-server
VC DHCP Option 43 Received	show dhcpc-opts
VC Global Alerts	show alert global
VC Global Statistics	show stats global
VC IDS AP List	show ids aps
VC IDS Client List	show ids clients
VC Internal DHCP Server Configuration	show ip dhcp database
VC L2TPv3 config	show l2tpv3 config
VC L2TPv3 session status	show l2tpv3 session status
VC L2TPv3 system wide global statistics	show l2tpv3 system statistics
VC L2TPv3 tunnel configuration	show l2tpv3 tunnel config
VC L2TPv3 tunnel status	show l2tpv3 tunnel status
VC Local User Database	show users
VC OpenDNS Configuration and Status	show.opendns support
VC Provisioning Log	show log provision
VC Radius Attributes	show radius-attributes
VC Radius Servers	show radius-servers support
AP Radius Status	show radius status
VC Saved Configuration	show configuration
VC Scanning Stats	show aps scanning
VC Show SBR Table	show datapath sbr
VC SNMP Configuration	show snmp-configuration
VC Uplink 3G/4G Configuration	show cellular config
VC Uplink Management Configuration	show uplink config
VC WISPr Configuration	show wispr config
VC XML API Server Information	show xml-api-server
VC rfc3576-radius statistics	show ap debug rfc3576-radius-statistics



Use the support commands under the supervision of Alcatel-Lucent technical support.

Uplink Bandwidth Monitoring

OAW-IAP uses Iperf3 as a TCP or UDP client to run a speed test and measure the bandwidth on an uplink. The results from the speed test are collated by the OAW-IAP and published to ALE. The speed tests can be run only on the Master OAW-IAP of the cluster. You may choose to configure and execute a speed test profile during boot time and additionally at specific time intervals using the Configuration Mode or execute the speed test at any preferred time using the Privileged EXEC mode in the CLI.

To configure and execute speed tests at specific time intervals using the configuration mode in the CLI:

```
(Instant AP) (config)# speed-test
(Instant AP) (speed-test)# include-reverse
(Instant AP) (speed-test)# server-ip <server>
(Instant AP) (speed-test)# server-port <port>
(Instant AP) (speed-test)# protocol <tcp/udp>
(Instant AP) (speed-test)# on-boot
(Instant AP) (speed-test)# time-interval <interval>
(Instant AP) (speed-test)# bandwidth <bandwidth>
(Instant AP) (speed-test)# sec-to-measure <secs>
(Instant AP) (speed-test)# end
(Instant AP) (speed-test)# commit apply
```

To configure and execute a speed test at any instant, using the privileged EXEC mode in the CLI:

```
(Instant AP)# speed-test <server> <protocol> [<bandwidth>|<include-reverse>|<sec-to-measure>
|<server-port>]
(Instant AP)# end
```

This chapter describes the following procedures:

- [Understanding Hotspot Profiles on page 377](#)
- [Configuring Hotspot Profiles on page 379](#)
- [Sample Configuration on page 390](#)



In the current release, AOS-W Instant supports the hotspot profile configuration only through the CLI.

Understanding Hotspot Profiles

Hotspot 2.0 is a Wi-Fi Alliance specification based on the 802.11u protocol, which allows wireless clients to discover hotspots using management frames (such as beacon, association request, and association response), connect to networks, and roam between networks without additional authentication.

The Hotspot 2.0 provides the following services:

- **Network discovery and selection**— Allows the clients to discover suitable and available networks by advertising the access network type, roaming consortium, and venue information through the management frames. For network discovery and selection, Generic Advertisement Service (GAS) and Access Network Query Protocol (ANQP) are used.
- **QoS Mapping**— Provides a mapping between the network-layer QoS packet marking and over-the-air QoS frame marking based on user priority.

When a hotspot is configured in a network:

- The clients search for available hotspots using the beacon management frame.
- When a hotspot is found, the client sends queries to obtain information about the type of network authentication and IP address, and IP address availability using the Generic Advertisement Service (GAS) action frames.
- Based on the response of the advertisement Server (response to the GAS Action Frames), the relevant hotspot is selected and the client attempts to associate with it.
- Based on the authentication mode used for mobility clients, the client authenticates to access the network.

Generic Advertisement Service (GAS)

GAS is a request-response protocol, which provides L2 transport mechanism between a wireless client and a server in the network prior to authentication. It helps in determining an 802.11 infrastructure before associating clients and allows clients to send queries to multiple 802.11 networks in parallel.

An AP can include its service provider Organization Identifier (OI) indicating the service provider identity in beacons and probe responses to clients. When a client recognizes an OAW-IAP's OI, it attempts to associate to that OAW-IAP using the security credentials corresponding to that service provider. If the client does not recognize the AP's OI, the client sends a Generic Advertisement Service (GAS) query to the OAW-IAP to request more information about the network before associating. A client transmits a GAS Query using a GAS Initial Request frame and the OAW-IAP provides the query response or information on how to receive the query response in a GAS Initial Response frame. To transmit a GAS query for any advertisement protocol, the advertisement protocol ID must include the advertisement protocol information element with information about the advertisement protocol and its corresponding advertisement control.

Access Network Query Protocol (ANQP)

ANQP provides a range of information, such as IP address type and availability, roaming partners accessible through a hotspot, and the Extensible Authentication Protocol (EAP) method supported for authentication, for a query and response protocol. The ANQP Information Elements (IEs) provide additional data that can be sent from an OAW-IAP to the client to identify the OAW-IAP's network and service provider. If a client requests this information through a GAS query, the hotspot AP sends the ANQP capability list in the GAS Initial Response frame indicating support for the following IEs:

- Venue Name
- Domain Name
- Network Authentication Type
- Roaming Consortium List
- Network Access Identifier Realm
- 3GPP Cellular Network Data

Hotspot 2.0 Query Protocol (H2QP)

The H2QP profiles provide a range of information on hotspot 2.0 elements such as hotspot protocol and port, operating class, operator names, WAN status, and uplink and downlink metrics.

Information Elements (IEs) and Management Frames

The hotspot 2.0 configuration supports the following IEs:

- Interworking IE—Provides information about the Interworking service capabilities such as the Internet availability in a specific service provider network.
- Advertisement Protocol IE—Provides information about the advertisement protocol that a client can use for communication with the advertisement servers in a network.
- Roaming Consortium IE—Provides information about the service provider network for roaming clients, which can be used to authenticate with the AP.

The IEs are included in the following Management Frames when 802.11u is enabled:

- Beacon Frame
- Probe Request Frame
- Probe response frame
- Association Request
- Re-Association request

NAI Realm List

An NAI Realm profile identifies and describes a NAI realm to which the clients can connect. The NAI realm settings on an OAW-IAP as an advertisement profile to determine the NAI realm elements that must be included as part of a GAS Response frame.

Configuring Hotspot Profiles

To configure a hotspot profile, perform the following steps:

1. Create the required ANQP and H2QP advertisement profiles.
2. Create a hotspot profile.
3. Associate the required ANQP and H2QP advertisement profiles created in step 1 to the hotspot profile created in step 2.
4. Create a SSID Profile with enterprise security and WPA2 encryption settings and associate the SSID with the hotspot profile created in step 2.

Creating Advertisement Profiles for Hotspot Configuration

A hotspot profile contains one or several advertisement profiles. The following advertisement profiles can be configured through the AOS-W Instant CLI:

- ANQP advertisement profiles
 - NAI Realm profile
 - Venue Name Profile
 - Network Authentication Profile
 - Roaming Consortium Profile
 - 3GPP Profile
 - IP Address availability Profile
 - Domain Name Profile
- H2QP advertisement profiles
 - Operator Friendly Name Profile
 - Connection Capability Profile
 - Operating Class Profile
 - WAN-Metrics Profile

Configuring an NAI Realm Profile

You configure a Network Access Identifier (NAI) Realm profile to define the NAI realm information, which can be sent as an ANQP IE in a GAS query response.

To configure a NAI profile, enter the following commands at the command prompt:

```
(Instant AP) (config)# hotspot anqp-nai-realm-profile <name>
(Instant AP) (nai-realm <name>)# nai-realm-name <name>
(Instant AP) (nai-realm <name>)# nai-realm-encoding {<utf8>|<rfc4282>}
(Instant AP) (nai-realm <name>)# nai-realm-eap-method <eap-method>
(Instant AP) (nai-realm <name>)# nai-realm-auth-id-1 <authentication-ID>
(Instant AP) (nai-realm <name>)# nai-realm-auth-id-2 <authentication-ID>
(Instant AP) (nai-realm <name>)# nai-realm-auth-value-1 <authentication-value>
(Instant AP) (nai-realm <name>)# nai-realm-auth-value-2 <authentication-value>
(Instant AP) (nai-realm <name>)# nai-home-realm
(Instant AP) (nai-realm <name>)# enable
(Instant AP) (nai-realm <name>)# end
(Instant AP)# commit apply
```

You can specify any of the following EAP methods for the **nai-realm-eap-method <eap-method>** command:

- **identity**— To use EAP Identity type. The associated numeric value is 1.
- **notification**—To allow the hotspot realm to use EAP Notification messages for authentication. The associated numeric value is 2.
- **one-time-password**—To use Authentication with a single-use password. The associated numeric value is 5.
- **generic-token-card**—To use EAP Generic Token Card (EAP-GTC). The associated numeric value is 6.
- **eap-tls**—To use EAP-Transport Layer Security. The associated numeric value is 13.
- **eap-sim**—To use EAP for GSM Subscriber Identity Modules. The associated numeric value is 18.
- **eap-ttls**—To use EAP-Tunneled Transport Layer Security. The associated numeric value is 21.
- **peap**—To use protected Extensible Authentication Protocol. The associated numeric value is 25.
- **crypto-card**— To use crypto card authentication. The associated numeric value is 28.
- **peapmschapv2**— To use PEAP with Microsoft Challenge Handshake Authentication Protocol version 2 (MSCHAPV2). The associated numeric value is 29.
- **eap-aka**—To use EAP for UMTS Authentication and Key Agreement. The associated numeric value is 50.

The following table lists the possible authentication IDs and their respective values:

Table 75: NAI Realm Profile Configuration Parameters

Authentication ID	Authentication Value
<p>reserved</p> <ul style="list-style-type: none"> • Uses the reserved authentication method. • The associated numeric value is 0. 	—
<p>expanded-eap</p> <ul style="list-style-type: none"> • Uses the expanded EAP authentication method. • The associated numeric value is 1. 	Use expanded-eap as the authentication value.
<p>non-eap-inner-auth</p> <ul style="list-style-type: none"> • Uses non-EAP inner authentication type. • The associated numeric value is 2. 	<p>The following authentication values apply:</p> <ul style="list-style-type: none"> • reserved— The associated numeric value is 0. • pap—The associated numeric value is 1. • chap—The associated numeric value is 2. • mschap—The associated numeric value is 3. • mschapv2—The associated numeric value is 4.

Table 75: NAI Realm Profile Configuration Parameters

Authentication ID	Authentication Value
<p>eap-inner-auth</p> <ul style="list-style-type: none"> • Uses EAP inner authentication type. • The associated numeric value is 3. 	<p>The following authentication values apply:</p> <ul style="list-style-type: none"> • reserved— The associated numeric value is 0. • pap—The associated numeric value is 1. • chap—The associated numeric value is 2. • mschap—The associated numeric value is 3. • mschapv2—The associated numeric value is 4.
<p>exp-inner-eap</p> <ul style="list-style-type: none"> • Uses the expanded inner EAP authentication method. • The associated numeric value is 4. 	<p>Use the exp-inner-eap authentication value.</p>
<p>credential</p> <ul style="list-style-type: none"> • Uses credential authentication. • The associated numeric value is 5. 	<p>The following authentication values apply:</p> <ul style="list-style-type: none"> • sim— The associated numeric value is 1. • usim— The associated numeric value is 2. • nfc-secure— The associated numeric value is 3. • hw-token— The associated numeric value is 4. • softoken— The associated numeric value is 5. • certificate— The associated numeric value is 6. • uname-password—The associated numeric value is 7. • none—The associated numeric value is 8. • reserved—The associated numeric value is 9. • vendor-specific—The associated numeric value is 10.

Configuring a Venue Name Profile

You configure a venue name profile to send venue information as an ANQP IE in a GAS query response. To configure a venue name profile, enter the following commands at the command prompt:

```
(Instant AP) (config)# hotspot anqp-venue-name-profile <name>
(Instant AP) (venue-name <name>)# venue-name <name>
(Instant AP) (venue-name <name>)# venue-group <group-name>
(Instant AP) (venue-name <name>)# venue-type <type>
(Instant AP) (venue-name <name>)# venue-lang-code <language>
(Instant AP) (venue-name <name>)# enable
(Instant AP) (venue-name <name>)# end
(Instant AP)# commit apply
```

You can specify any of the following venue groups and the corresponding venue types:

Table 76: Venue Types

Venue Group	Associated Venue Type Value
<p>unspecified The associated numeric value is 0.</p>	
<p>assembly The associated numeric value is 1.</p>	<ul style="list-style-type: none"> ● unspecified—The associated numeric value is 0. ● arena—The associated numeric value is 1. ● stadium—The associated numeric value is 2. ● passenger-terminal—The associated numeric value is 3. ● amphitheater—The associated numeric value is 4. ● amusement-park—The associated numeric value is 5. ● place-of-worship—The associated numeric value is 6. ● convention-center—The associated numeric value is 7. ● library—The associated numeric value is 8. ● museum—The associated numeric value is 9. ● restaurant—The associated numeric value is 10. ● theater—The associated numeric value is 11. ● bar —The associated numeric value is 12. ● coffee-shop —The associated numeric value is 13. ● zoo-or-aquarium —The associated numeric value is 14. ● emergency-cord-center—The associated numeric value is 15.
<p>business The associated numeric value is 2.</p>	<ul style="list-style-type: none"> ● unspecified—The associated numeric value is 0. ● doctor—The associated numeric value is 1 ● bank—The associated numeric value is 2 ● fire-station—The associated numeric value is 3 ● police-station—The associated numeric value is 4 ● post-office—The associated numeric value is 6 ● professional-office—The associated numeric value is 7 ● research-and-dev-facility—The associated numeric value is 8 ● attorney-office—The associated numeric value is 9
<p>educational The associated numeric value is 3.</p>	<ul style="list-style-type: none"> ● unspecified—The associated numeric value is 0. ● school-primary—The associated numeric value is 1. ● school-secondary—The associated numeric value is 2. ● univ-or-college—The associated numeric value is 3.
<p>factory-and-industrial The associated numeric value is 4.</p>	<ul style="list-style-type: none"> ● unspecified—The associated numeric value is 0. ● factory—The associated numeric value is 1.
<p>institutional The associated numeric value is 5.</p>	<ul style="list-style-type: none"> ● unspecified—The associated numeric value is 0. ● hospital—The associated numeric value is 1.

Venue Group	Associated Venue Type Value
	<ul style="list-style-type: none"> ● long-term-care—The associated numeric value is 2. ● alc-drug-rehab—The associated numeric value is 3. ● group-home—The associated numeric value is 4. ● prison-or-jail—The associated numeric value is 5.
<p>mercantile The associated numeric value is 6.</p>	<ul style="list-style-type: none"> ● unspecified—The associated numeric value is 0. ● retail-store—The associated numeric value is 1. ● grocery-market—The associated numeric value is 2. ● auto-service-station—The associated numeric value is 3. ● shopping-mall—The associated numeric value is 4. ● gas-station—The associated numeric value is 5
<p>residential The associated numeric value is 7.</p>	<ul style="list-style-type: none"> ● unspecified—The associated numeric value is 0. ● private-residence—The associated numeric value is 1. ● hotel—The associated numeric value is 3 ● dormitory—The associated numeric value is 4 ● boarding-house—The associated numeric value is 5.
<p>storage The associated numeric value is 8.</p>	<p>unspecified—The associated numeric value is 0.</p>
<p>utility-misc The associated numeric value is 9.</p>	<p>unspecified—The associated numeric value is 0.</p>
<p>vehicular The associated numeric value is 10</p>	<ul style="list-style-type: none"> ● unspecified—The associated numeric value is 0. ● automobile-or-truck—The associated numeric value is 1. ● airplane—The associated numeric value is 2. ● bus—The associated numeric value is 3. ● ferry—The associated numeric value is 4. ● ship —The associated numeric value is 5. ● train —The associated numeric value is 6. ● motor-bike—The associated numeric value is 7.
<p>outdoor The associated numeric value is 11.</p>	<ul style="list-style-type: none"> ● unspecified—The associated numeric value is 0 ● muni-mesh-network—The associated numeric value is 1. ● city-park—The associated numeric value is 2. ● rest-area—The associated numeric value is 3. ● traffic-control—The associated numeric value is 4 ● bus-stop—The associated numeric value is 5 ● kiosk —The associated numeric value is 6

Configuring a Network Authentication Profile

You can configure a network authentication profile to define the authentication type used by the hotspot network. To configure a network authentication profile, enter the following commands at the command prompt:

```
(Instant AP) (config)# hotspot anqp-nwk-auth-profile <name>
(Instant AP) (network-auth <name>)# nwk-auth-type <type>
(Instant AP) (network-auth <name>)# url <URL>
(Instant AP) (network-auth <name>)# enable
(Instant AP) (network-auth <name>)# end
(Instant AP)# commit apply
```

You can specify any of the following network authentication type for the **nwk-auth-type <type>** command:

- **accept-term-and-cond**—When configured, the network requires the user to accept terms and conditions. This option requires you to specify a redirection URL string as an IP address, FQDN or URL.
- **online-enrollment**—When configured, the network supports the online enrollment.
- **http-redirect**—When configured, additional information on the network is provided through HTTP/HTTPS redirection.
- **dns-redirect**—When configured, additional information on the network is provided through DNS redirection. This option requires you to specify a redirection URL string as an IP address, FQDN, or URL.

Configuring a Roaming Consortium Profile

You can configure a roaming consortium profile to send the roaming consortium information as an ANQP IE in a GAS query response. To configure a roaming consortium profile, enter the following commands at the command prompt:

```
(Instant AP) (config)# hotspot anqp-roam-cons-profile <name>
(Instant AP) (roaming-consortium <name>)# roam-cons-oi <roam-cons-oi>
(Instant AP) (roaming-consortium <name>)# roam-cons-oi-len <roam-cons-oi-len>
(Instant AP) (roaming-consortium <name>)# enable
(Instant AP) (roaming-consortium <name>)# end
(Instant AP)# commit apply
```

Specify a hexadecimal string of 3 to 5 octets for **roam-cons-oi <roam-cons-oi>**.

Based on the OI specified, you can specify the following parameters for the length of OI in **roam-cons-oi-len <roam-cons-oi-len>**.

- For 0: 0 Octets in the OI (Null)
- For 3: OI length is 24-bit (3 Octets)
- For 5: OI length is 36-bit (5 Octets)

Configuring a 3GPP Profile

You can configure a 3rd Generation Partnership Project (3GPP) profile to define information for the 3G Cellular Network for hotspots.

To configure a 3GPP profile, enter the following commands at the command prompt:

```
(Instant AP) (config)# hotspot anqp-3gpp-profile <name>
(Instant AP) (3gpp <name>)# 3gpp-plmn1 <plmn-ID>
(Instant AP) (3gpp <name>)# enable
(Instant AP) (3gpp <name>)# end
(Instant AP)# commit apply
```

The Public Land Mobile Network (PLMN) ID is a combination of the mobile country code and network code. You can specify up to 6 PLMN IDs for a 3GPP profile.

Configuring an IP Address Availability Profile

You can configure the available IP address types to send information on IP address availability as an ANQP IE in a GAS query response. To configure an IP address availability profile, enter the following commands at the command prompt:

```
(Instant AP) (config) # hotspot anqp-ip-addr-avail-profile <name>
(Instant AP) (IP-addr-avail <name>) # ipv4-addr-avail
(Instant AP) (IP-addr-avail <name>) # ipv6-addr-avail
(Instant AP) (IP-addr-avail <name>) # enable
(Instant AP) (IP-addr-avail <name>) # end
(Instant AP) # commit apply
```

Configuring a Domain Profile

You can configure a domain profile to send the domain names as an ANQP IE in a GAS query response. To configure a domain name profile, enter the following commands at the command prompt:

```
(Instant AP) (config) # hotspot anqp-domain-name-profile <name>
(Instant AP) (domain-name <name>) # domain-name <domain-name>
(Instant AP) (domain-name <name>) # enable
(Instant AP) (domain-name <name>) # end
(Instant AP) # commit apply
```

Configuring an Operator-friendly Profile

You can configure the operator-friendly name profile to define the identify the operator. To configure an H2QP operator-friendly name profile:

```
(Instant AP) (config) # hotspot h2qp-oper-name-profile <name>
(Instant AP) (operator-friendly-name <name>) # op-fr-name <op-fr-name>
(Instant AP) (operator-friendly-name <name>) # op-lang-code <op-lang-code>
(Instant AP) (operator-friendly-name <name>) # enable
(Instant AP) (operator-friendly-name <name>) # end
(Instant AP) # commit apply
```

Configuring a Connection Capability Profile

You can configure a Connection Capability profile to define information such as the hotspot IP protocols and associated port numbers that are available for communication. To configure an H2QP connection capability profile:

```
(Instant AP) (config) # hotspot h2qp-conn-cap-profile
(Instant AP) (connection-capabilities <name>) # esp-port
(Instant AP) (connection-capabilities <name>) # icmp
(Instant AP) (connection-capabilities <name>) # tcp-ftp
(Instant AP) (connection-capabilities <name>) # tcp-http
(Instant AP) (connection-capabilities <name>) # tcp-pptp-vpn
(Instant AP) (connection-capabilities <name>) # tcp-ssh
(Instant AP) (connection-capabilities <name>) # tcp-tls-vpn
(Instant AP) (connection-capabilities <name>) # tcp-voip
(Instant AP) (connection-capabilities <name>) # udp-ike2
(Instant AP) (connection-capabilities <name>) # udp-ipsec-vpn
(Instant AP) (connection-capabilities <name>) # udp-voip
(Instant AP) (connection-capabilities <name>) # enable
(Instant AP) (connection-capabilities <name>) # end
(Instant AP) # commit apply
```

Configuring an Operating Class Profile

You can configure an operating class profile to list the channels on which the hotspot is capable of operating. To configure an H2QP operating class profile:

```
(Instant AP) (config) # hotspot h2qp-oper-class-profile <name>
(Instant AP) (operator-class <name>) # op-class <class-ID>
```

```
(Instant AP) (operator-class <name>)# enable
(Instant AP) (operator-class <name>)# end
(Instant AP)# commit apply
```

Configuring a WAN Metrics Profile

You can configure a WAN metrics profile to define information about access network characteristics such as link status and metrics. To configure a WAN metrics profile:

```
(Instant AP) (config)# hotspot h2qp-wan-metrics-profile <name>
(Instant AP) (WAN-metrics <name>)# at-capacity
(Instant AP) (WAN-metrics <name>)# downlink-load <load>
(Instant AP) (WAN-metrics <name>)# downlink-speed <speed>
(Instant AP) (WAN-metrics <name>)# load-duration <duration>
(Instant AP) (WAN-metrics <name>)# symm-link
(Instant AP) (WAN-metrics <name>)# uplink-load <load>
(Instant AP) (WAN-metrics <name>)# uplink-speed <speed>
(Instant AP) (WAN-metrics <name>)# wan-metrics-link-status <status>
(Instant AP) (WAN-metrics <name>)# end
(Instant AP)# commit apply
```

You can specify the following WAN downlink and uplink parameters:

- **Downlink load**— Indicates the percentage of the WAN downlink currently utilized. The default value of 0 indicates that the downlink speed is unknown or unspecified.
- **Downlink speed**—Indicates the WAN downlink speed in Kbps.
- **Uplink load**—Indicates the percentage of the WAN uplink currently utilized. The default value of 0 indicates that the downlink speed is unknown or unspecified.
- **Uplink speed**—Indicates the WAN uplink speed in Kbps.
- **Load duration**—Indicates the duration in seconds during which the downlink utilization is measured.
- **Symmetric links**—Indicates if the uplink and downlink have the same speed.
- **WAN Link Status**— Indicates if the WAN is down (link-down), up (link-up), or in test state (link-under-test).

Creating a Hotspot Profile

To create a hotspot profile:

```
(Instant AP) (config)# hotspot hs-profile <name>
(Instant AP) (Hotspot2.0 <name>)# asra
(Instant AP) (Hotspot2.0 <name>)# access-network-type <type>
(Instant AP) (Hotspot2.0 <name>)# addtl-roam-cons-ois <roam-consortium-OIs>
(Instant AP) (Hotspot2.0 <name>)# comeback-mode
(Instant AP) (Hotspot2.0 <name>)# gas-comeback <delay-interval>
(Instant AP) (Hotspot2.0 <name>)# group-frame-block
(Instant AP) (Hotspot2.0 <name>)# hessid <hotspot-ssid>
(Instant AP) (Hotspot2.0 <name>)# internet
(Instant AP) (Hotspot2.0 <name>)# p2p-cross-connect
(Instant AP) (Hotspot2.0 <name>)# p2p-dev-mgmt
(Instant AP) (Hotspot2.0 <name>)# pame-bi
(Instant AP) (Hotspot2.0 <name>)# query-response-length-limit <integer>
(Instant AP) (Hotspot2.0 <name>)# roam-cons-len-1 <integer>
(Instant AP) (Hotspot2.0 <name>)# roam-cons-len-2 <integer>
(Instant AP) (Hotspot2.0 <name>)# roam-cons-len-3 <integer>
(Instant AP) (Hotspot2.0 <name>)# roam-cons-oi-1 <integer>
(Instant AP) (Hotspot2.0 <name>)# roam-cons-oi-2 <integer>
(Instant AP) (Hotspot2.0 <name>)# roam-cons-oi-3 <integer>
(Instant AP) (Hotspot2.0 <name>)# venue-group <group>
(Instant AP) (Hotspot2.0 <name>)# venue-type <type>
(Instant AP) (Hotspot2.0 <name>)# enable
(Instant AP) (Hotspot2.0 <name>)# end
(Instant AP)#commit apply
```

The hotspot profile configuration parameters are described in the following table:

Table 77: Hotspot Configuration Parameters

Parameter	Description
access-network-type <type>	<p>Specify any of the following 802.11u network types.</p> <ul style="list-style-type: none"> • private—This network is accessible for authorized users only. For example, home networks or enterprise networks that require user authentication. The corresponding integer value for this network type is 0. • private-with-guest—This network is accessible to guest users based on guest authentication methods. For example, enterprise networks that allow guest users with captive portal authentication. The corresponding integer value for this network type is 1. • chargeable-public—This network provides access to the Internet based on payment. For example, a subscription-based Internet access in a coffee shop or a hotel offering chargeable in-room Internet access service. The corresponding integer value for this network type is 2. • free-public—This network is accessible to all without any charges applied. For example, a hotspot in airport or other public places that provide Internet access with no additional cost. The corresponding integer value for this network type is 3. • personal-device—This network is accessible for personal devices. For example, a laptop or camera configured with a printer for the purpose of printing. The corresponding integer value for this network type is 4. • emergency-services—This network is limited to accessing emergency services only. The corresponding integer value for this network type is 5. • test—This network is used for test purposes only. The corresponding integer value for this network type is 14. • wildcard—This network indicates a wildcard network. The corresponding integer value for this network type is 15.
addtl-roam-cons-ois	Specify the number of additional roaming consortium Organization Identifiers (OIs) advertised by the AP. You can specify up to three additional OIs.
asra	Enable the Additional Steps Required for Access (asra) to indicate if additional steps are required for authentication. When enabled, the following information is sent to the client in response to an ANQP query. For ASRA, ensure that the network authentication type is associated.
comeback-mode	Enable this parameter to allow the client to obtain a GAS Request and Response as a Comeback-Request and Comeback-Response. By default, this comeback mode is disabled.
gas-comeback-delay	Specify a GAS come back delay interval in milliseconds to allow the client to retrieve the query response using a comeback request action frame when the GAS response is delayed. You can specify a value within the range of 100-2000 milliseconds and the default value is 500 milliseconds.
group-frame-block	Enable this parameter if you want to stop the AP from sending forward downstream group-addressed frames.

Table 77: Hotspot Configuration Parameters

Parameter	Description
hessid	Specify a Homogenous Extended Service Set Identifier (HESSID) in a hexadecimal format separated by colons.
internet	Specify this parameter to allow the OAW-IAP to send an Information Element (IE) indicating that the network allows Internet access.
p2p-cross-connect	Specify this parameter to advertise support for P2P Cross Connections.
p2p-dev-mgmt	Specify this parameter to advertise support for P2P device management.
pame-bi	Specify this parameter to enable Pre-Association Message Exchange BSSID Independent (PAME-BI) bit, with which the OAW-IAP can indicate that the Advertisement Server can return a query response independent of the BSSID used in the GAS Frame exchange.
query-response-length-limit	Specify this parameter to set the maximum length of the GAS query response, in octets. You can specify a value within the range of 1-127. The default value is 127.
roam-cons-len-1 roam-cons-len-2 roam-cons-len-3	Specify the length of the organization identifier. The value of the roam-cons-len-1 , roam-cons-len-2 , or roam-cons-len-3 . The roaming consortium OI is based on the following parameters: <ul style="list-style-type: none"> ● 0: Zero Octets in the OI (Null) ● 3: OI length is 24-bit (3 Octets) ● 5: OI length is 36-bit (5 Octets)
venue-group	Specify one of the following venue groups <ul style="list-style-type: none"> ● assembly ● business ● educational ● factory-and-industrial ● institutional ● mercantile ● outdoor ● residential ● storage ● utility-and-misc ● vehicular <p>By default, the business venue group is used.</p>
venue-type	Specify a venue type to be advertised in the ANQP IEs from OAW-IAPs associated with this hotspot profile. For more information about the supported venue types for each venue group, see Table 76 .

Associating an Advertisement Profile to a Hotspot Profile

To associate a hotspot profile with an advertisement profile:

```

(Instant AP) (config)# hotspot hs-profile <name>
(Instant AP) (Hotspot2.0 <name>)# advertisement-protocol <protocol>
(Instant AP) (Hotspot2.0 <name>)# advertisement-profile anqp-3gpp <name>
(Instant AP) (Hotspot2.0 <name>)# advertisement-profile anqp-domain-name <name>
(Instant AP) (Hotspot2.0 <name>)# advertisement-profile anqp-ip-addr-avail <name>
(Instant AP) (Hotspot2.0 <name>)# advertisement-profile anqp-nai-realm <name>
(Instant AP) (Hotspot2.0 <name>)# advertisement-profile anqp-nwk-auth <name>
(Instant AP) (Hotspot2.0 <name>)# advertisement-profile anqp-roam-cons <name>
(Instant AP) (Hotspot2.0 <name>)# advertisement-profile anqp-venue-name <name>
(Instant AP) (Hotspot2.0 <name>)# advertisement-profile h2qp-conn-cap <name>
(Instant AP) (Hotspot2.0 <name>)# advertisement-profile h2qp-oper-class <name>
(Instant AP) (Hotspot2.0 <name>)# advertisement-profile h2qp-oper-name <name>
(Instant AP) (Hotspot2.0 <name>)# advertisement-profile h2qp-wan-metrics <name>
(Instant AP) (Hotspot2.0 <name>)# end
(Instant AP)# commit apply

```

The configuration parameters for associating an advertisement profile with a hotspot profile are described in the following table:

Table 78: Advertisement Association Parameters

Parameter	Description
advertisement-profile	Specify the advertisement profile to associate with this hotspot profile. For information on advertisement profiles, see Creating Advertisement Profiles for Hotspot Configuration on page 379 .
advertisement-protocol	Specify the advertisement protocol types as Access Network Query Protocol (ANQP) as anqp .

Creating a WLAN SSID and Associating Hotspot Profile

To create a WLAN SSID with Enterprise Security and WPA2 Encryption Settings:

```

(Instant AP) (config)# wlan ssid-profile <name>
(Instant AP) (SSID Profile <name>)# essid <ESSID-name>
(Instant AP) (SSID Profile <name>)# type {<Employee> | <Voice>| <Guest>}
(Instant AP) (SSID Profile <name>)# vlan <vlan-ID>
(Instant AP) (SSID Profile <name>)# set-vlan <attribute>{equals|not-equals|starts-with|ends-with|contains} <operator> <VLAN-ID>| value-of}
(Instant AP) (SSID Profile <name>)# opmode {wpa2-aes|wpa-tkip,wpa2-aes}
(Instant AP) (SSID Profile <name>)# blacklist
(Instant AP) (SSID Profile <name>)# mac-authentication
(Instant AP) (SSID Profile <name>)# l2-auth-failthrough
(Instant AP) (SSID Profile <name>)# termination
(Instant AP) (SSID Profile <name>)# external-server
(Instant AP) (SSID Profile <name>)# auth-server <server-name>
(Instant AP) (SSID Profile <name>)# server-load-balancing
(Instant AP) (SSID Profile <name>)# radius-accounting
(Instant AP) (SSID Profile <name>)# radius-accounting-mode {user-authentication| user-association}
(Instant AP) (SSID Profile <name>)# radius-interim-accounting-interval <minutes>
(Instant AP) (SSID Profile <name>)# radius-reauth-interval <minutes>
(Instant AP) (SSID Profile <name>)# set-role-by-ssid
(Instant AP) (SSID Profile <name>)# hotspot-profile <name>
(Instant AP) (SSID Profile <name>)# end
(Instant AP)# commit apply

```

Sample Configuration

Step 1 - Creating ANQP and H2QP Advertisement Profile

```
(Instant AP) # configure terminal
(Instant AP) (config) # hotspot anqp-nai-realm-profile nr1
(Instant AP) (nai-realm "nr1") # nai-realm-name name1
(Instant AP) (nai-realm "nr1") # nai-realm-encoding utf8
(Instant AP) (nai-realm "nr1") # nai-realm-eap-method eap-sim
(Instant AP) (nai-realm "nr1") # nai-realm-auth-id-1 non-eap-inner-auth
(Instant AP) (nai-realm "nr1") # nai-realm-auth-value-1 mschapv2
(Instant AP) (nai-realm "nr1") # nai-home-realm
(Instant AP) (nai-realm "nr1") # exit

(Instant AP) (config) # hotspot anqp-venue-name-profile vn1
(Instant AP) (venue-name "vn1") # venue-group business
(Instant AP) (venue-name "vn1") # venue-type research-and-dev-facility
(Instant AP) (venue-name "vn1") # venue-lang-code eng
(Instant AP) (venue-name "vn1") # venue-name VenueName
(Instant AP) (venue-name "vn1") # exit

(Instant AP) (config) # hotspot anqp-nwk-auth-profile na1
(Instant AP) (network-auth "na1") # nwk-auth-type accept-term-and-cond
(Instant AP) (network-auth "na1") # url www.nwkauth.com
(Instant AP) (network-auth "na1") # exit

(Instant AP) (config) # hotspot anqp-roam-cons-profile rc1
(Instant AP) (roaming-consortium "rc1") # roam-cons-oi-len 3
(Instant AP) (roaming-consortium "rc1") # roam-cons-oi 888888
(Instant AP) (roaming-consortium "rc1") # exit

(Instant AP) (config) # hotspot anqp-3gpp-profile 3g
(Instant AP) (3gpp "3g") # 3gpp-plmn1 40486
(Instant AP) (3gpp "3g") # exit

(Instant AP) (config) # hotspot anqp-ip-addr-avail-profile ip1
(Instant AP) (IP-addr-avail "ip1") # no ipv4-addr-avail
(Instant AP) (IP-addr-avail "ip1") # ipv6-addr-avail
(Instant AP) (IP-addr-avail "ip1") # exit

(Instant AP) (config) # hotspot anqp-domain-name-profile dn1
(Instant AP) (domain-name "dn1") # domain-name DomainName
(Instant AP) (domain-name "dn1") # exit

(Instant AP) (config) # hotspot h2qp-oper-name-profile on1
(Instant AP) (operator-friendly-name"on1") # op-lang-code eng
(Instant AP) (operator-friendly-name"on1") # op-fr-name OperatorFriendlyName
(Instant AP) (operator-friendly-name"on1") # exit
```

Step 2: Creating a hotspot profile

```
(Instant AP) # configure terminal
(Instant AP) (config) # hotspot hs-profile hs1
(Instant AP) (Hotspot2.0 "hs1") # enable
(Instant AP) (Hotspot2.0 "hs1") # comeback-mode
(Instant AP) (Hotspot2.0 "hs1") # gas-comeback-delay 10
(Instant AP) (Hotspot2.0 "hs1") # no asra
(Instant AP) (Hotspot2.0 "hs1") # no internet
(Instant AP) (Hotspot2.0 "hs1") # query-response-length-limit 20
(Instant AP) (Hotspot2.0 "hs1") # access-network-type chargeable-public
(Instant AP) (Hotspot2.0 "hs1") # roam-cons-len-1 3
(Instant AP) (Hotspot2.0 "hs1") # roam-cons-oi-1 123456
(Instant AP) (Hotspot2.0 "hs1") # roam-cons-len-2 3
```

```

(Instant AP) (Hotspot2.0 "hs1")# roam-cons-oi-2 223355
(Instant AP) (Hotspot2.0 "hs1")# addttl-roam-cons-ois 0
(Instant AP) (Hotspot2.0 "hs1")# venue-group business
(Instant AP) (Hotspot2.0 "hs1")# venue-type research-and-dev-facility
(Instant AP) (Hotspot2.0 "hs1")# pame-bi
(Instant AP) (Hotspot2.0 "hs1")# group-frame-block
(Instant AP) (Hotspot2.0 "hs1")# p2p-dev-mgmt
(Instant AP) (Hotspot2.0 "hs1")# p2p-cross-connect
(Instant AP) (Hotspot2.0 "hs1")# end
(Instant AP)# commit apply

```

Step 3: Associating advertisement profiles with the hotspot profile

```

(Instant AP)# configure terminal
(Instant AP)(config)# hotspot hs-profile hs1
(Instant AP) (Hotspot2.0 "hs1")# advertisement-profile anqp-nai-realm nr1
(Instant AP) (Hotspot2.0 "hs1")# advertisement-profile anqp-venue-name vn1
(Instant AP) (Hotspot2.0 "hs1")# advertisement-profile anqp-nwk-auth nal
(Instant AP) (Hotspot2.0 "hs1")# advertisement-profile anqp-roam-cons rc1
(Instant AP) (Hotspot2.0 "hs1")# advertisement-profile anqp-3gpp 3g1
(Instant AP) (Hotspot2.0 "hs1")# advertisement-profile anqp-ip-addr-avail ip1
(Instant AP) (Hotspot2.0 "hs1")# advertisement-profile anqp-domain-name dn1
(Instant AP) (Hotspot2.0 "hs1")# advertisement-profile h2qp-oper-name on1
(Instant AP) (Hotspot2.0 "hs1")# advertisement-profile h2qp-wan-metrics wml
(Instant AP) (Hotspot2.0 "hs1")# advertisement-profile h2qp-conn-cap cc1
(Instant AP) (Hotspot2.0 "hs1")# advertisement-profile h2qp-oper-class ocl
(Instant AP) (Hotspot2.0 "hs1")# exit

```

Step 4: Associate the hotspot profile with WLAN SSID:

```

(Instant AP)# configure terminal
(Instant AP)# wlan ssid-profile ssidProfile1
(Instant AP) (SSID Profile "ssidProfile1")# essid hsProf
(Instant AP) (SSID Profile "ssidProfile1")# type employee
(Instant AP) (SSID Profile "ssidProfile1")# vlan 200
(Instant AP) (SSID Profile "ssidProfile1")# opmode wpa2-aes
(Instant AP) (SSID Profile "ssidProfile1")# blacklist
(Instant AP) (SSID Profile "ssidProfile1")# mac-authentication
(Instant AP) (SSID Profile "ssidProfile1")# l2-auth-failthrough
(Instant AP) (SSID Profile "ssidProfile1")# radius-accounting
(Instant AP) (SSID Profile "ssidProfile1")# radius-accounting-mode user-association
(Instant AP) (SSID Profile "ssidProfile1")# radius-interim-accounting-interval 10
(Instant AP) (SSID Profile "ssidProfile1")# radius-reauth-interval 20
(Instant AP) (SSID Profile "ssidProfile1")# max-authentication-failures 2
(Instant AP) (SSID Profile "ssidProfile1")# set-role-by-ssid
(Instant AP) (SSID Profile "ssidProfile1")# hotspot-profile hs1
(Instant AP) (SSID Profile "ssidProfile1")# end
(Instant AP)# commit apply

```

To configure ClearPass Guest:

1. On ClearPass Guest, navigate to **Administration > AirGroup Services**.
2. Click **Configure AirGroup Services**.

Figure 113 *Configure AirGroup Services*

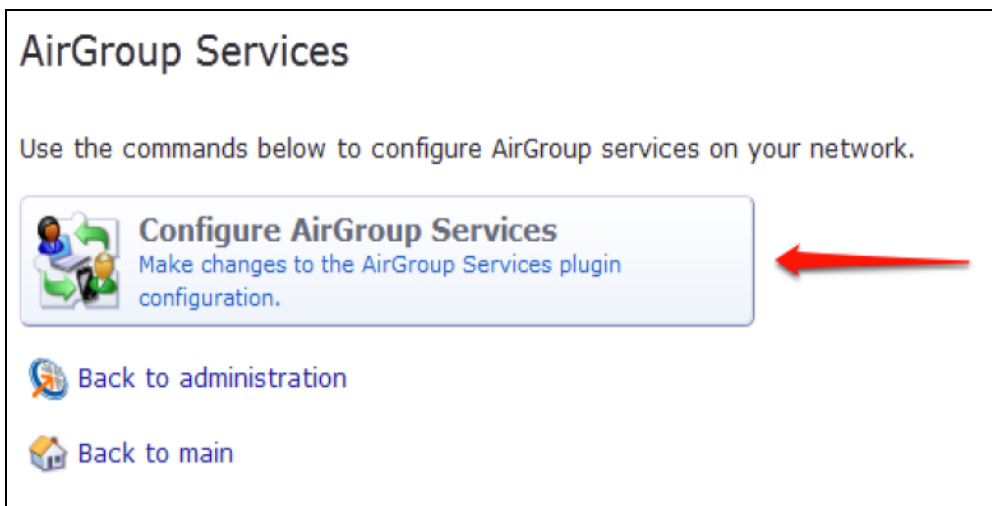

3. Click **Add a new controller**.
4. Update the fields with the appropriate information.



Ensure that the port configured matches the CoA port (RFC 3576) set on the OAW-IAP configuration.

5. Click **Save Configuration**.

In order to demonstrate AirGroup, either an AirGroup Administrator or an AirGroup Operator account must be created.

1. Navigate to the ClearPass Policy Manager UI, and navigate to **Configuration > Identity > Local Users**.

Figure 114 *Configuration > Identity > Local Users Selection*

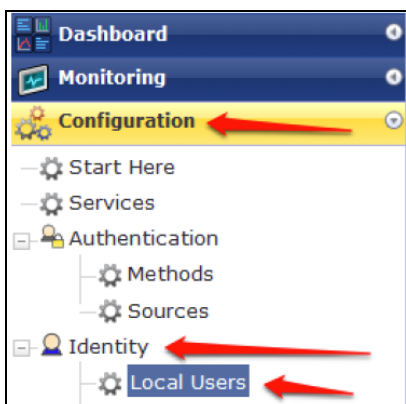

2. Click **Add User**.

3. Create an **AirGroup Administrator**.

Figure 115 Create an AirGroup Administrator

The screenshot shows the 'Add Local User' dialog box with the following fields and values:

User ID	airgroup-admin
Name	AirGroup Admin
Password
Verify Password
Enable User	<input checked="" type="checkbox"/> (Check to enable local user)
Role	[AirGroup Administrator] 

Below the fields is an 'Attributes' section with a table:

Attribute	Value
1. Click to add...	

At the bottom right are 'Add' and 'Cancel' buttons.

4. In this example, the password used is test123. Click **Add**.

5. Now click **Add User**, and create an **AirGroup Operator**.

Figure 116 Create an AirGroup Operator

The screenshot shows the 'Add Local User' dialog box with the following fields and values:

User ID	airgroup-oper
Name	AirGroup Operator
Password
Verify Password
Enable User	<input checked="" type="checkbox"/> (Check to enable local user)
Role	[AirGroup Operator] 

Below the fields is an 'Attributes' section with a table:

Attribute	Value
1. Click to add...	

At the bottom right are 'Add' and 'Cancel' buttons.

6. Click **Add** to save the user with an **AirGroup Operator** role. The **AirGroup Administrator** and **AirGroup Operator** IDs will be displayed in the **Local Users UI** screen.

Figure 117 Local Users UI Screen

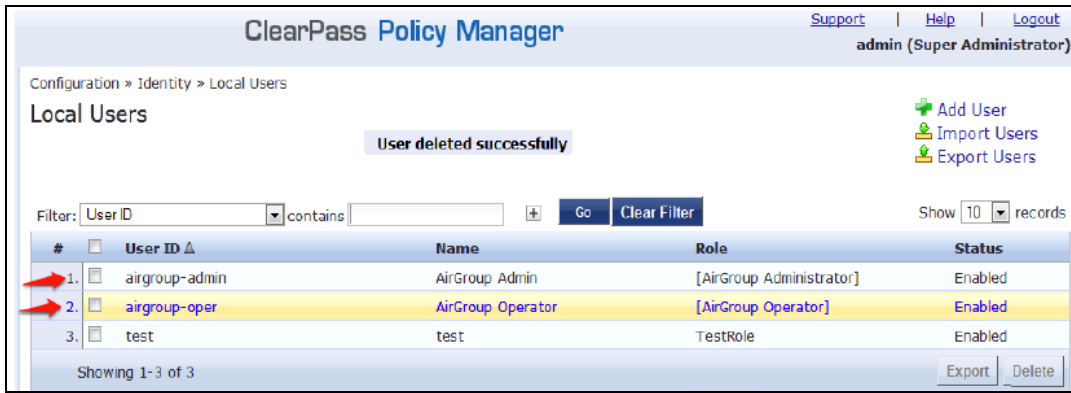

7. Navigate to the ClearPass Guest UI and click **Logout**. The **ClearPass Guest Login** page is displayed. Use the AirGroup admin credentials to log in.
8. After logging in, click **Create Device**.

Figure 118 Create a Device



The following page is displayed.

Figure 119 - Register Shared Device

Register Shared Device	
* Device Name:	<input type="text"/> Enter a name to identify the device.
* MAC Address:	<input type="text"/> Enter the MAC address of the device.
Shared Locations:	<input type="text"/> Enter a list of location IDs where this device will be shared. Use a comma-separated list of tag=value pairs; tag may be AP-Name, AP-Group, or FQLN. A fully qualified location name is '<ap-name>.floor<N>.<building-name>.<campus>'. Leave blank to share with all locations.
Shared With:	<input type="text"/> Enter up to 10 usernames that will be able to use this device. Use a comma-separated list, e.g. user1,user2,user3, or blank for all users.
Shared Roles:	<input type="text"/> List the user roles that will be able to use this device. Use a comma-separated list, e.g. role1,role2,role3, or blank for all roles.
<input type="button" value="Register Shared Device"/>	

For this test, add your AppleTV device name and MAC address but leave all other fields empty.

9. Click **Register Shared Device**.

Testing

To verify the setup:

1. Disconnect your AppleTV and OSX Mountain Lion/iOS 6 devices if they were previously connected to the wireless network. Remove their entries from the switch's user table using these commands:
 - Find the MAC address— `show user table`
 - Delete the address from the table— `aaa user delete mac 00:aa:22:bb:33:cc`
2. Reconnect both devices. To limit access to the AppleTV, access the ClearPass Guest UI using either the AirGroup admin or the AirGroup operator credentials. Next, navigate to **List Devices > Test Apple TV > Edit**. Add a username that is not used to log in to the Apple devices in the **Shared With field**.
3. Disconnect and remove the OSX Mountain Lion/iOS 6 device from the switch's user table. Reconnect the device by not using the username that you added to the **Shared With field**. The AppleTV should not be available to this device.
4. Disconnect the OSX Mountain Lion/iOS 6 device and delete it from the switch's user table. Reconnect using the username that was added to the **Shared With field**. The OSX Mountain Lion/iOS 6 device should once again have access to the AppleTV.

Troubleshooting

Table 79: *Troubleshooting*

Problem	Solution
Limiting devices has no effect.	Ensure IPv6 is disabled.
Apple Macintosh running Mountain Lion can use AirPlay but iOS devices cannot.	Ensure IPv6 is disabled.

This section describes the most common IAP-VPN deployments models and provides information to carry out the necessary configuration procedures. The examples in this section refer to more than one DHCP profile and wired port configuration in addition to wireless SSID configuration. All these are optional. In most networks, a single DHCP profile and wireless SSID configuration referring a DHCP profile is sufficient.

The following scenarios are described in this section:

- [Scenario 1—IPSec: Single Datacenter Deployment with No Redundancy on page 397](#)
- [Scenario 2—IPSec: Single Datacenter with Multiple Switches for Redundancy on page 401](#)
- [Scenario 3—IPSec: Multiple Datacenter Deployment with Primary and Backup Switches for Redundancy on page 405](#)
- [Scenario 4—GRE: Single Datacenter Deployment with No Redundancy on page 410](#)

Scenario 1—IPSec: Single Datacenter Deployment with No Redundancy

This scenario includes the following configuration elements:

1. Single VPN primary configuration using IPSec
2. Split tunneling of client traffic
3. Split tunneling of DNS traffic from clients
4. Distributed L3 and Centralized L2 mode DHCP
5. RADIUS server within corporate network and authentication survivability for branch survivability
6. Wired and wireless users in L2 and L3 modes respectively
7. Access rules defined for wired and wireless networks to permit all traffic

Topology

Figure 120 shows the topology and the IP addressing scheme used in this scenario.

Figure 120 Scenario 1—IPSec: Single datacenter Deployment with No Redundancy

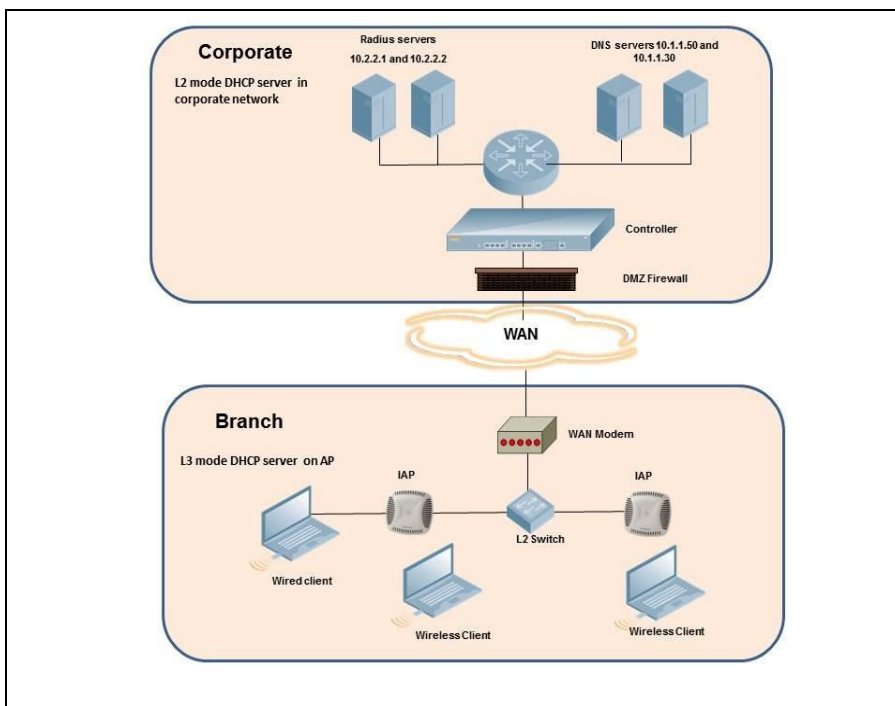

The following IP addresses are used in the examples for this scenario:

- 10.0.0.0/8 is the corporate network
- 10.20.0.0/16 subnet is reserved for L2 mode
- 10.30.0.0/16 subnet is reserved for L3 mode
- Client count in each branch is 200

AP Configuration

The following table provides information on the configuration steps performed through the CLI with example values. For information on the UI procedures, see the topics referenced in the *UI Navigation Details* column.

Table 80: OAW-IAP Configuration for Scenario 1—IPSec: Single Datacenter Deployment with No Redundancy

Configuration Steps	CLI Commands	UI Procedure
1. Configure the primary host for VPN with the Public VRRP IP address of the switch.	<pre>(ap) (config)# vpn primary <public VRRP IP of switch></pre>	See Configuring an IPSec Tunnel
2. Configure a routing profile to tunnel all 10.0.0.0/8 subnet traffic to switch.	<pre>(ap) (config)# routing-profile (ap)(routing-profile)# route 10.0.0.0 255.0.0.0 <public VRRP IP of switch></pre>	See Configuring Routing Profiles
3. Configure Enterprise DNS for split DNS. The example in the next column uses a specific enterprise domain to only tunnel all DNS queries matching that domain to corporate.	<pre>(ap) (config)# internal-domains (ap) (domains)# domain-name corpdomain.com</pre>	See Configuring Enterprise Domains
4. Configure centralized L2 and distributed L3 with VLAN 20 and 30 respectively.	<p>Centralized L2 profile</p> <pre>(ap) (config)# ip dhcp l2-dhcp (ap) (DHCP Profile "l2-dhcp")# server-type Centralized,L2 (ap) (DHCP Profile "l2-dhcp")# server-vlan 20</pre> <p>Distributed L3 profile</p> <pre>(ap) (config)# ip dhcp l3-dhcp (ap) (DHCP Profile "l3-dhcp")# server-type Distributed,L3 (ap) (DHCP Profile "l3-dhcp")# server-vlan 30 (ap) (DHCP Profile "l3-dhcp")# ip-range 10.30.0.0 10.30.255.255 (ap) (DHCP Profile "l3-dhcp")# dns-server 10.1.1.50,10.1.1.30 (ap) (DHCP Profile "l3-dhcp")# domain-name corpdomain.com (ap) (DHCP Profile "l3-dhcp")# client-count 200</pre> <p>NOTE: The IP range configuration on each branch will be the same. Each OAW-IAP will derive a smaller subnet based on the client count scope using the Branch ID (BID) allocated by switch.</p>	See Configuring Centralized DHCP Scopes and Configuring Distributed DHCP Scopes
5. Create authentication servers for user authentication. The example in the next column assumes 802.1X SSID.	<pre>(ap) (config)# wlan auth-server server1 (ap) (Auth Server "server1")# ip 10.2.2.1 (ap) (Auth Server "server1")# port 1812 (ap) (Auth Server "server1")# acctport 1813 (ap) (Auth Server "server1")# key "presharedkey" (ap) (Auth Server "server1")# exit (ap) (config)# wlan auth-server server2 (ap) (Auth Server "server2")# ip 10.2.2.2 (ap) (Auth Server "server2")# port 1812 (ap) (Auth Server "server2")# acctport 1813 (ap) (Auth Server "server2")# key "presharedkey"</pre>	See Configuring an External Server for Authentication
6. Configure wired and wireless SSIDs using the	Configure wired ports to operate in L2 mode and associate centralized L2 mode VLAN 20 to the wired port profile.	See Configuring a

Table 80: OAW-IAP Configuration for Scenario 1—IPSec: Single Datacenter Deployment with No Redundancy

Configuration Steps	CLI Commands	UI Procedure
<p>authentication servers and access rules created above and enable authentication survivability.</p>	<pre>(ap) (config) # wired-port-profile wired-port (ap) (wired-port-profile "wired-port") # switchport-mode access (ap) (wired-port-profile "wired-port") # allowed-vlan all (ap) (wired-port-profile "wired-port") # native-vlan 20 (ap) (wired-port-profile "wired-port") # no shutdown (ap) (wired-port-profile "wired-port") # access-rule-name wired-port (ap) (wired-port-profile "wired-port") # type employee (ap) (wired-port-profile "wired-port") # auth-server server1 (ap) (wired-port-profile "wired-port") # auth-server server2 (ap) (wired-port-profile "wired-port") # dot1x (ap) (wired-port-profile "wired-port") # exit (ap) (config) # enet1-port-profile wired-port</pre> <p>Configure a wireless SSID to operate in L3 mode and associate distributed L3 mode VLAN 30 to the WLAN SSID profile.</p> <pre>(ap) (config) # wlan ssid-profile wireless-ssid (ap) (SSID Profile "wireless-ssid") # enable (ap) (SSID Profile "wireless-ssid") # type employee (ap) (SSID Profile "wireless-ssid") # essid wireless-ssid (ap) (SSID Profile "wireless-ssid") # opmode wpa2-aes (ap) (SSID Profile "wireless-ssid") # vlan 30 (ap) (SSID Profile "wireless-ssid") # auth-server server1 (ap) (SSID Profile "wireless-ssid") # auth-server server2 (ap) (SSID Profile "wireless-ssid") # auth-survivability</pre>	<p>Wired Profile and Wireless Network Profiles</p>
<p>7. Create access rule for wired and wireless authentication. In this example, the rule permits all traffic.</p>	<p>For wired profile:</p> <pre>(ap) (config) # wlan access-rule wired-port (ap) (Access Rule "wired-port") # rule any any match any any any permit</pre> <p>For WLAN SSID:</p> <pre>(ap) (config) # wlan access-rule wireless-ssid (ap) (Access Rule "wireless-ssid") # rule any any match any any any permit</pre>	<p>See Configuring ACL Rules for Network Services</p>
<p>NOTE: Ensure that you execute the commit apply command in the AOS-W Instant CLI before saving the configuration and propagating changes across the OAW-IAP cluster.</p>		

AP Connected Switch Configuration

Client VLANs defined in this example must be opened on the upstream switches in multi AP deployments, as client traffic from slave to master is tagged with the client VLAN.

Datacenter Configuration

For information on switch configuration, see [Configuring a Switch for IAP-VPN Operations on page 251](#). Ensure that the upstream router is configured with a static route pointing to the switch for the L3 VLAN.

Scenario 2—IPSec: Single Datacenter with Multiple Switches for Redundancy

This scenario includes the following configuration elements:

- A VRRP instance between the master/standby-master pair, which is configured as the primary VPN IP address.
- Tunneling of all traffic to datacenter.
- Exception route to bypass tunneling of RADIUS and OmniVista traffic, which are locally reachable in the branch and the Internet respectively.
- All client DNS queries are tunneled to the switch.
- Distributed L3 and Centralized L2 mode DHCP on all branches. L3 is used by the employee network and L2 is used by the guest network with captive portal.
- Wired and wireless users in L2 and L3 modes.
- Access rules defined for wired and wireless networks.

Topology

Figure 121 shows the topology and the IP addressing scheme used in this scenario.

Figure 121 Scenario 2—IPSec: Single Datacenter with Multiple switches for Redundancy

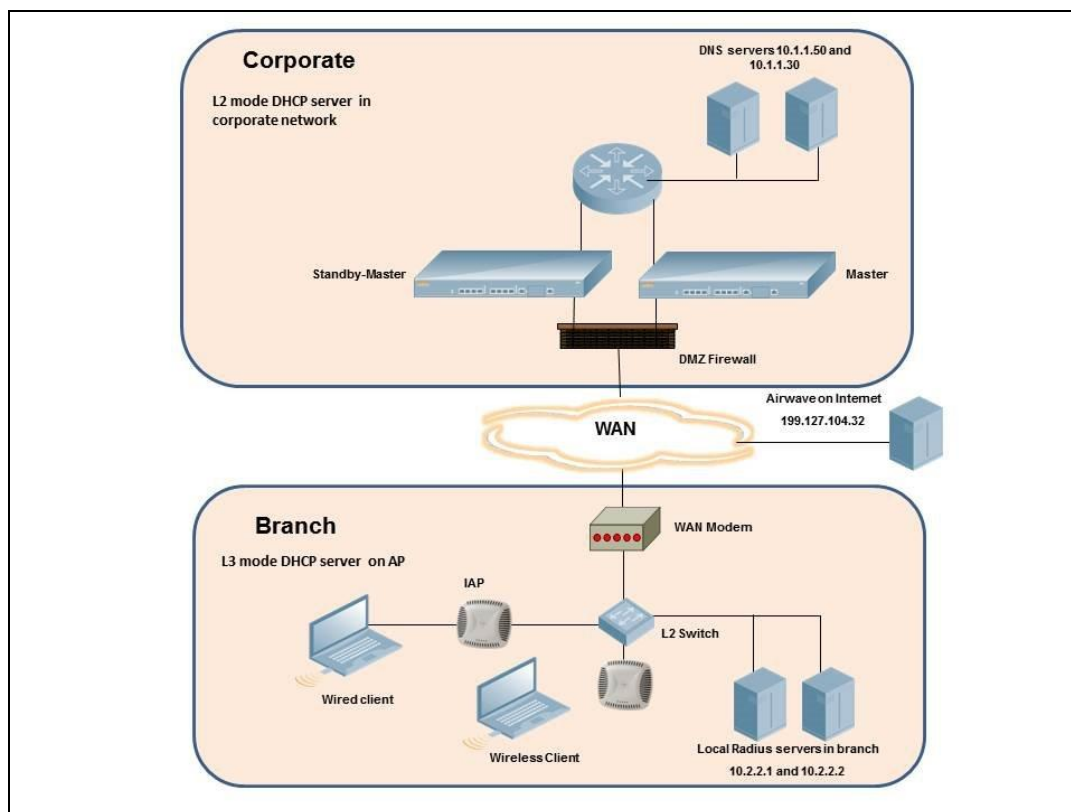

The following IP addresses are used in the examples for this scenario:

- 10.0.0.0/8 is the corporate network
- 10.20.0.0/16 subnet is reserved for L2 mode – used for guest network
- 10.30.0.0/16 subnet is reserved for L3 mode
- Client count in each branch is 200

- 10.2.2.0/24 is a branch owned subnet, which needs to override global routing profile
- 199.127.104.32 is used an example IP address of the OmniVista server in the Internet

AP Configuration

The following table provides information on the configuration steps performed through the CLI with example values. For information on the UI procedures, see the topics referenced in the *UI Navigation Details* column.

Table 81: OAW-IAP Configuration for Scenario 2—IPSec: Single Datacenter with Multiple switches for Redundancy

Configuration Steps	CLI Commands	UI Procedure
1. Configure the primary host for VPN with the Public VRRP IP address of the switch.	<pre>(ap) (config)# vpn primary <public VRRP IP of switch></pre>	See Configuring an IPSec Tunnel
2. Configure routing profiles to tunnel traffic through IPSec.	<pre>(ap) (config)# routing-profile (ap)(routing-profile)# route 0.0.0.0 0.0.0.0 <public VRRP IP of switch></pre>	See Configuring Routing Profiles
3. Define routing profile exception RADIUS server and OmniVista IPs, since the design requirement for this solution requires local RADIUS authentication, even though the IP matches the routing profile destination.	<pre>(ap) (config)# routing-profile (ap) (routing-profile)# route 10.2.2.1 255.255.255.255 0.0.0.0 (ap) (routing-profile)# route 10.2.2.2 255.255.255.255 0.0.0.0 (ap) (routing-profile)# route 199.127.104.32 255.255.255.255 0.0.0.0</pre>	See Configuring Routing Profiles
4. Configure Enterprise DNS. The configuration example in the next column tunnels all DNS queries to the original DNS server of clients without proxying on OAW-IAP.	<pre>(ap) (config)# internal-domains (ap) (domains)# domain-name *</pre>	See Configuring Enterprise Domains
5. Configure centralized L2 and distributed L3 with VLAN 20 and 30 respectively.	<pre>Centralized L2 profile (ap) (config)# ip dhcp l2-dhcp (ap) (DHCP Profile "l2-dhcp")# server-type Centralized,L2 (ap) (DHCP Profile "l2-dhcp")# server-vlan 20 Distributed L3 profile (ap) (config)# ip dhcp l3-dhcp (ap) (DHCP Profile "l3-dhcp")# server-type Distributed,L3 (ap) (DHCP Profile "l3-dhcp")# server-vlan 30 (ap) (DHCP Profile "l3-dhcp")# ip-range 10.30.0.0 10.30.255.255 (ap) (DHCP Profile "l3-dhcp")# dns-server 10.1.1.50,10.1.1.30 (ap) (DHCP Profile "l3-dhcp")# domain-name corpdomain.com (ap) (DHCP Profile "l3-dhcp")# client-count 200</pre>	See Configuring Centralized DHCP Scopes and Configuring Distributed DHCP Scopes

Table 81: OAW-IAP Configuration for Scenario 2—IPSec: Single Datacenter with Multiple switches for Redundancy

Configuration Steps	CLI Commands	UI Procedure
	<p>NOTE: The IP range configuration on each branch will be the same. Each OAW-IAP will derive a smaller subnet based on the client count scope using the Branch ID (BID) allocated by switch.</p>	
<p>6. Create authentication servers for user authentication. The example in the next column assumes 802.1X SSID.</p>	<pre>(ap) (config)# wlan auth-server server1 (ap) (Auth Server "server1")# ip 10.2.2.1 (ap) (Auth Server "server1")# port 1812 (ap) (Auth Server "server1")# acctport 1813 (ap) (Auth Server "server1")# key "presharedkey" (ap) (Auth Server "server1")# exit (ap) (config)# wlan auth-server server2 (ap) (Auth Server "server2")# ip 10.2.2.2 (ap) (Auth Server "server2")# port 1812 (ap) (Auth Server "server2")# acctport 1813 (ap) (Auth Server "server2")# key "presharedkey"</pre>	<p>See Configuring an External Server for Authentication</p>
<p>7. Configure wired and wireless SSIDs using the authentication servers and access rules created above and enable authentication survivability.</p>	<p>Configure wired ports to operate in L3 mode and associate distributed L3 mode VLAN 30 to the wired port profile.</p> <pre>(ap) (config) # wired-port-profile wired-port (ap) (wired-port-profile "wired-port")# switchport-mode access (ap) (wired-port-profile "wired-port")# allowed-vlan all (ap) (wired-port-profile "wired-port")# native-vlan 30 (ap) (wired-port-profile "wired-port")# no shutdown (ap) (wired-port-profile "wired-port")# access-rule-name wired-port (ap) (wired-port-profile "wired-port")# type employee (ap) (wired-port-profile "wired-port")# auth-server server1 (ap) (wired-port-profile "wired-port")# auth-server server2 (ap) (wired-port-profile "wired-port")# dot1x (ap) (wired-port-profile "wired-port")# exit (ap) (config)# enet1-port-profile wired-port</pre> <p>Configure a wireless SSID to operate in L2 mode and associate Centralized L2 mode VLAN 20 to the WLAN SSID profile.</p> <pre>(ap) (config) # wlan ssid-profile guest (ap) (SSID Profile "guest")# enable (ap) (SSID Profile "guest")# type guest (ap) (SSID Profile "guest")# essid guest (ap) (SSID Profile "guest")# opmode opensystem (ap) (SSID Profile "guest")# vlan 20 (ap) (SSID Profile "guest")# auth-server server1 (ap) (SSID Profile "guest")# auth-server server2 (ap) (SSID Profile "guest")# captive-portal internal</pre> <p>NOTE: This example uses internal captive portal use case using external authentication server. You can also use an external</p>	<p>See Configuring a Wired Profile and Wireless Network Profiles</p>

Table 81: OAW-IAP Configuration for Scenario 2—IPSec: Single Datacenter with Multiple switches for Redundancy

Configuration Steps	CLI Commands	UI Procedure
	<p>captive portal example.</p> <p>NOTE: The SSID type guest is used in this example to enable configuration of captive portal. However, corporate access through VPN tunnel is still allowed for this SSID because the VLAN associated to this SSID is a VPN enabled VLAN (20 in this example).</p>	
8. Create access rule for wired and wireless authentication. In this example, the rule permits all traffic.	<p>For wired profile:</p> <pre>(ap) (config) # wlan access-rule wired-port (ap) (Access Rule "wired-port") # rule any any match any any any permit</pre> <p>For WLAN SSID:</p> <pre>(ap) (config) # wlan access-rule guest (ap) (Access Rule "guest") # rule any any match any any any permit</pre>	See Configuring ACL Rules for Network Services
<p>NOTE: Ensure that you execute the commit apply command in the AOS-W Instant CLI before saving the configuration and propagating changes across the OAW-IAP cluster.</p>		

AP Connected Switch Configuration

Client VLANs defined in this example must be opened on the upstream switches in multiple AP deployments, as client traffic from slave to master is tagged with the client VLAN.

Datacenter Configuration

For information on switch configuration, see [Configuring a Switch for IAP-VPN Operations on page 251](#). Ensure that the upstream router is configured with a static route pointing to the switch for the L3 VLAN.

Scenario 3—IPSec: Multiple Datacenter Deployment with Primary and Backup Switches for Redundancy

This scenario includes the following configuration elements:

- Multiple switch deployment model with switches in different datacenters operating as primary/backup VPN with fast-failover and pre-emption enabled.
- Split tunneling of traffic.
- Split tunneling of client DNS traffic.
- Two Distributed L3 mode DHCPs, one each for employee and contractors and one Local mode DHCP server.
- RADIUS server within corporate network and authentication survivability enabled for branch survivability.
- Wired and wireless users in L3 and NAT modes respectively.
- Access rules for wired and wireless users with source NAT based rule for contractor roles to bypass global routing profile.
- OSPF based route propagation on switch.

Topology

Figure 122 shows the topology and the IP addressing scheme used in this scenario.

Figure 122 Scenario 3—IPSec: Multiple Datacenter Deployment with Primary and Backup Switches for Redundancy

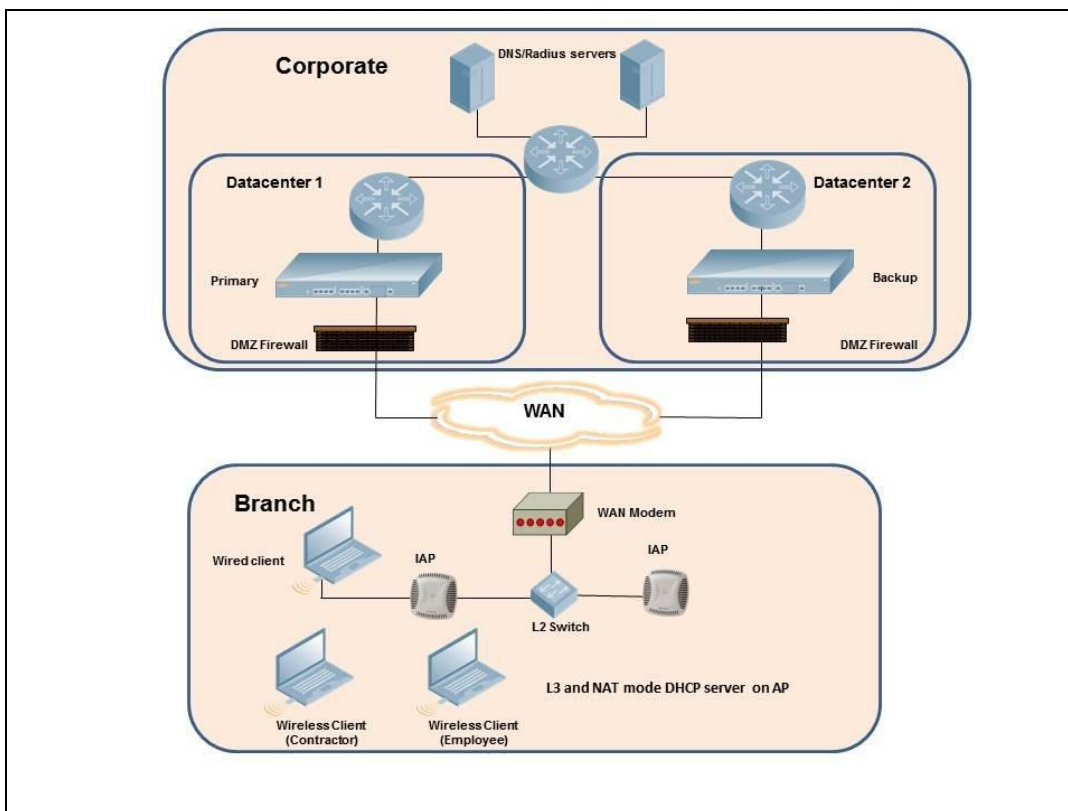

The IP addressing scheme used in this example is as follows:

- 10.0.0.0/8 is the corporate network.
- 10.30.0.0/16 subnet is reserved for L3 mode –used by Employee SSID.

- 10.40.0.0/16 subnet is reserved for L3 mode –used by Contractor SSID.
- 172.16.20.0/24 subnet is used for NAT mode – used for wired network.
- Client count in each branch is 200.
- Contractors are only permitted to reach 10.16.0.0/16 network.

AP Configuration

This section provides information on configuration steps performed through the CLI or the UI.

Table 82: OAW-IAP Configuration for Scenario 3—IPSec: Multiple Datacenter Deployment

Configuration Steps	CLI Commands	UI Procedure
1. Configure the primary IP address. This IP address is the Public IP address of the switch. Fast failover is enabled for fast convergence.	<pre>(ap) (config)# vpn primary <public IP of primary switch> (ap) (config)# vpn backup <public IP of backup switches> (ap) (config)# vpn preemption (ap) (config)# vpn fast-failover</pre>	See Configuring an IPSec Tunnel
2. Configure routing profiles to tunnel traffic through IPSec.	<pre>(ap) (config)# routing-profile (ap) (routing-profile)# route 0.0.0.0 0.0.0.0 <public IP of primary switch> (ap) (routing-profile)# route 10.0.0.0 255.0.0.0 <public IP of backup switch></pre>	See Configuring Routing Profiles
3. Configure Enterprise DNS for split DNS. The example in the next column uses a specific enterprise domain to tunnel all DNS queries matching that domain to corporate.	<pre>(ap) (config)# internal-domains (ap) (domains)# domain-name corpdomain.com</pre>	See Configuring Enterprise Domains
4. Configure distributed L3 DHCP profiles with VLAN 30 and 40.	<pre>Distributed L3 profile with VLAN 30 (ap) (config)# ip dhcp l3-dhcp (ap) (DHCP profile "l3-dhcp")# server-type Distributed,L3 (ap) (DHCP profile "l3-dhcp")# server-vlan 30 (ap) (DHCP profile "l3-dhcp")# ip-range 10.30.0.0 10.30.255.255 (ap) (DHCP profile "l3-dhcp")# dns-server 10.1.1.50,10.1.1.30 (ap) (DHCP profile "l3-dhcp")# domain-name corpdomain.com (ap) (DHCP profile "l3-dhcp")# client-count 200 Distributed L3 profile with VLAN 40 (ap) (config)# ip dhcp l3-dhcp (ap) (DHCP profile "l3-dhcp")# server-type Distributed,L3 (ap) (DHCP profile "l3-dhcp")# server-vlan 40 (ap) (DHCP profile "l3-dhcp")# ip-range 10.40.0.0 10.40.255.255 (ap) (DHCP profile "l3-dhcp")# dns-server 10.1.1.50,10.1.1.30 (ap) (DHCP profile "l3-dhcp")# domain-name corpdomain.com</pre>	See Configuring Distributed DHCP Scopes and Configuring Local DHCP Scopes

Table 82: OAW-IAP Configuration for Scenario 3—IPSec: Multiple Datacenter Deployment

Configuration Steps	CLI Commands	UI Procedure
	<pre>(ap) (DHCP profile "l3-dhcp")# client-count 200</pre> <p>Local profile with VLAN 20</p> <pre>(ap) (config)# ip dhcp local (ap) (DHCP profile "local")# server-type Local (ap) (DHCP profile "local")# server-vlan 20 (ap) (DHCP profile "local")# subnet 172.16.20.1 (ap) (DHCP profile "local")# subnet-mask 255.255.255.0 (ap) (DHCP profile "local")# lease-time 86400 (ap) (DHCP profile "local")# dns-server 10.1.1.30,10.1.1.50 (ap) (DHCP profile "local")# domain-name arubanetworks.com</pre> <p>NOTE: The IP range configuration on each branch will be the same. Each OAW-IAP will derive a smaller subnet based on the client count scope using the Branch ID (BID) allocated by switch.</p>	
<p>5. Create authentication servers for user authentication. The example in the next column assumes 802.1X SSID.</p>	<pre>(ap) (config)# wlan auth-server server1 (ap) (Auth Server "server1")# ip 10.2.2.1 (ap) (Auth Server "server1")# port 1812 (ap) (Auth Server "server1")# acctport 1813 (ap) (Auth Server "server1")# key "presharedkey" (ap) (Auth Server "server1")# exit</pre> <pre>(ap) (config)# wlan auth-server server2 (ap) (Auth Server "server1")# ip 10.2.2.2 (ap) (Auth Server "server1")# port 1812 (ap) (Auth Server "server1")# acctport 1813 (ap) (Auth Server "server1")# key "presharedkey"</pre>	<p>See Configuring an External Server for Authentication</p>
<p>6. Configure wired and wireless SSIDs using the authentication servers and access rules and enable authentication survivability.</p>	<p>Configure wired ports to operate in NAT mode and associate VLAN 20 to the wired port profile.</p> <pre>(ap) (config) # wired-port-profile wired-port (ap) (wired-port-profile "wired-port")# switchport-mode access (ap) (wired-port-profile "wired-port")# allowed-vlan all (ap) (wired-port-profile "wired-port")# native-vlan 20 (ap) (wired-port-profile "wired-port")# no shutdown (ap) (wired-port-profile "wired-port")# access-rule-name wired-port (ap) (wired-port-profile "wired-port")# type employee (ap) (wired-port-profile "wired-port")# auth-server server1 (ap) (wired-port-profile "wired-port")# auth-server server2 (ap) (wired-port-profile "wired-port")# dot1x (ap) (wired-port-profile "wired-port")# exit (ap) (config)# enet1-port-profile wired-port</pre>	<p>See Configuring a Wired Profile and Wireless Network Profiles</p>

Table 82: OAW-IAP Configuration for Scenario 3—IPSec: Multiple Datacenter Deployment

Configuration Steps	CLI Commands	UI Procedure
	<p>Configure a wireless SSID to operate in L3 mode for employee and associate distributed L3 mode VLAN 30 to the WLAN SSID profile.</p> <pre>(ap) (config) # wlan ssid-profile wireless-ssid (ap) (SSID Profile "wireless-ssid") # enable (ap) (SSID Profile "wireless-ssid") # type employee (ap) (SSID Profile "wireless-ssid") # essid wireless-ssid (ap) (SSID Profile "wireless-ssid") # opmode wpa2-aes (ap) (SSID Profile "wireless-ssid") # vlan 30 (ap) (SSID Profile "wireless-ssid") # auth-server server1 (ap) (SSID Profile "wireless-ssid") # auth-server server2 (ap) (SSID Profile "wireless-ssid") # auth-survivability</pre> <p>Configure a wireless SSID is configured to operate in L3 mode for contractor and associate distributed L3 mode VLAN 40 to the WLAN SSID profile.</p> <pre>(ap) (config) # wlan ssid-profile wireless-ssid-contractor (ap) (SSID Profile "wireless-ssid-contractor") # enable (ap) (SSID Profile "wireless-ssid-contractor") # type employee (ap) (SSID Profile "wireless-ssid-contractor") # essid wireless-ssid-contractor (ap) (SSID Profile "wireless-ssid-contractor") # opmode wpa2-aes (ap) (SSID Profile "wireless-ssid-contractor") # vlan 40 (ap) (SSID Profile "wireless-ssid-contractor") # auth-server server1 (ap) (SSID Profile "wireless-ssid-contractor") # auth-server server2 (ap) (SSID Profile "wireless-ssid-contractor") # auth-survivability</pre>	
<p>7. Create access rule for wired and wireless authentication. In this example, the rule permits all traffic. For contractor SSID role, the rule allows only 10.16.0.0/16 network and all other traffic address is translated at the source and the global routing profile definition is bypassed.</p>	<p>For wired profile:</p> <pre>(ap) (config) # wlan access-rule wired-port (ap) (Access Rule "wired-port") # rule any any match any any any permit</pre> <p>For WLAN SSID employee roles:</p> <pre>(ap) (config) # wlan access-rule wireless-ssid (ap) (Access Rule "wireless-ssid") # rule any any match any any any permit</pre> <p>For WLAN SSID contractor roles:</p> <pre>(ap) (config) # wlan access-rule wireless-ssid-contractor</pre>	<p>See Configuring ACL Rules for Network Services</p>

Table 82: OAW-IAP Configuration for Scenario 3—IPSec: Multiple Datacenter Deployment

Configuration Steps	CLI Commands	UI Procedure
	<pre>(ap) (Access Rule "wireless-ssid-contractor")# rule 10.16.0.0 255.255.0.0 match any any any permit (ap) (Access Rule "wireless-ssid-contractor")# rule any any match any any any src-nat</pre>	
NOTE: Ensure that you execute the commit apply command in the AOS-W Instant CLI before saving the configuration and propagating changes across the OAW-IAP cluster.		

AP Connected Switch Configuration

Client VLANs defined in this example must be opened on the upstream switches in multiple AP deployments, as client traffic from slave to master is tagged with the client VLAN.

Datacenter Configuration

For information on switch configuration, see [Configuring a Switch for IAP-VPN Operations on page 251](#). The following OSPF configuration is required on the switch to redistribute IAP-VPN routes to upstream routers.

```
(host) (config) # router ospf
(host) (config) # router ospf router-id <ID>
(host) (config) # router ospf area 0.0.0.0
(host) (config) # router ospf redistribute rapng-vpn
```

Scenario 4—GRE: Single Datacenter Deployment with No Redundancy

This scenario includes the following configuration elements:

- Single VPN primary configuration using GRE
 - **Aruba GRE**, does not require any configuration on the Alcatel-Lucent OmniAccess WLAN Switch that acts as a GRE endpoint.
 - **Manual GRE**, which requires GRE tunnels to be explicitly configured on the GRE-endpoint that can be an Alcatel-Lucent OmniAccess WLAN Switch or any device that supports GRE termination.
- Tunneling of all traffic to datacenter
- Centralized L2 mode DHCP profile
- RADIUS server within corporate network and authentication survivability for branch survivability.
- Wired and wireless users in L2 mode
- Access rules defined for wired and wireless networks to permit all traffic

Topology

Figure 123 shows the topology and the IP addressing scheme used in this scenario:

Figure 123 Scenario 4 - GRE: Single Datacenter Deployment with No Redundancy

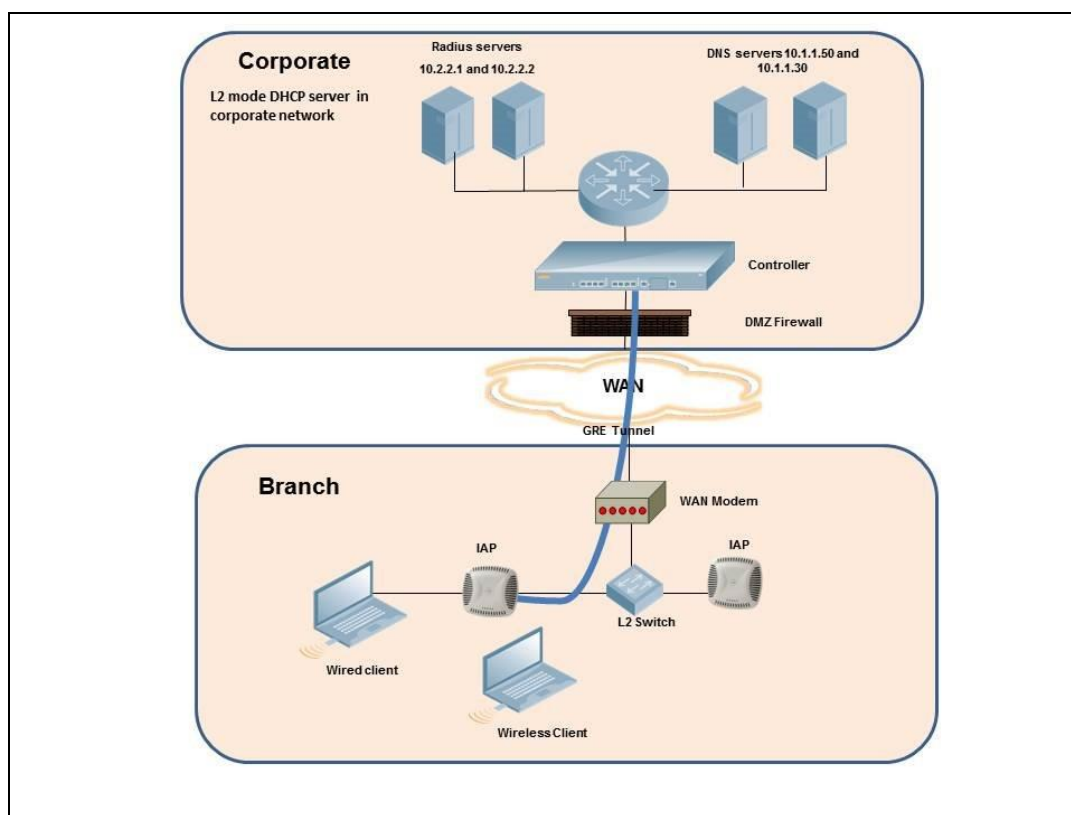

The following IP addresses are used in the examples for this scenario:

- 10.0.0.0/8 is the corporate network.
- 10.20.0.0/16 subnet is reserved for L2 mode.

AP Configuration

This section provides information on configuration steps performed through the CLI or the UI.

Table 83: OAW-IAP Configuration for Scenario—GRE: Single Datacenter Deployment with No Redundancy

Configuration Steps	CLI Commands	UI Procedure
<p>1. Configure Aruba GRE or manual GRE</p> <ul style="list-style-type: none"> Aruba GRE uses an IPSec tunnel to facilitate switch configuration and requires VPN to be configured. This VPN tunnel is not used for any client traffic. Manual GRE uses standard GRE tunnel configuration and requires switch configuration to complete the GRE tunnel. 	<p>Aruba GRE configuration</p> <pre>(ap) (config) # vpn primary <switch-IP> (ap) (config) # vpn gre-outside</pre> <p>Manual GRE configuration</p> <pre>(ap) (config) # gre primary <switch-IP> (ap) (config) # gre type 80</pre> <p>Per-AP GRE tunnel configuration</p> <p>Optionally, per-AP GRE tunnel can also be enabled, which causes each OAW-IAP to form an independent GRE tunnel to the GRE end-point. This requires each OAW-IAP MAC to be present in the switch whitelist if Aruba GRE is used, or GRE configuration for the IP of the each OAW-IAP on the switch for Manual GRE.</p> <pre>(ap) (config) # gre per-ap-tunnel</pre> <p>NOTE: Starting with 6.4.4.4-4.2.3.0, if Virtual Controller IP is configured and per-AP GRE tunnel is disabled, OAW-IAP uses Virtual Controller IP as the GRE source IP. For Manual GRE, this simplifies configuration on switch, since only the Virtual Controller IP destined GRE tunnel interface configuration is required.</p>	<p>See Configuring Alcatel-Lucent GRE Parameters and Configuring Manual GRE Parameters</p>
<p>2. Configure routing profiles to tunnel traffic through GRE.</p>	<pre>(ap) (config) # routing-profile (ap)(routing-profile)# route 0.0.0.0 0.0.0.0 <IP of GRE-endpoint></pre>	<p>See Configuring Routing Profiles</p>
<p>3. Configure Enterprise DNS. The example in the next column tunnels all DNS queries to the client's original DNS server without proxying on OAW-IAP.</p>	<pre>(ap) (config) # internal-domains (ap) (domains) # domain-name *</pre>	<p>See Configuring Enterprise Domains</p>
<p>4. Configure centralized L2 DHCP profile with VLAN 20.</p>	<p>Centralized L2 DHCP profile VLAN 20</p> <pre>(ap) (config) # ip dhcp l2-dhcp (ap) (DHCP profile "l2-dhcp") # server-type Centralized,L2 (ap) (DHCP profile "l2-dhcp") # server-vlan 20</pre>	<p>See Configuring Centralized DHCP Scopes</p>

Table 83: OAW-IAP Configuration for Scenario—GRE: Single Datacenter Deployment with No Redundancy

Configuration Steps	CLI Commands	UI Procedure
<p>5. Create authentication servers for user authentication. The example in the next column assumes 802.1X SSID.</p>	<pre>(ap) (config)# wlan auth-server server1 (ap) (Auth Server "server1")# ip 10.2.2.1 (ap) (Auth Server "server1")# port 1812 (ap) (Auth Server "server1")# acctport 1813 (ap) (Auth Server "server1")# key "presharedkey" (ap) (Auth Server "server1")# exit (ap) (config)# wlan auth-server server2 (ap) (Auth Server "server1")# ip 10.2.2.2 (ap) (Auth Server "server1")# port 1812 (ap) (Auth Server "server1")# acctport 1813 (ap) (Auth Server "server1")# key "presharedkey"</pre>	<p>See Configuring an External Server for Authentication</p>
<p>6. Configure wired and wireless SSIDs using the authentication servers and access rules, and enable authentication survivability.</p>	<p>Configure wired ports to operate in centralized L2 mode and associate VLAN 20 to the wired port profile.</p> <pre>(ap) (config) # wired-port-profile wired-port (ap) (wired-port-profile "wired-port")# switchport-mode access (ap) (wired-port-profile "wired-port")# allowed-vlan all (ap) (wired-port-profile "wired-port")# native-vlan 20 (ap) (wired-port-profile "wired-port")# no shutdown (ap) (wired-port-profile "wired-port")# access-rule-name wired-port (ap) (wired-port-profile "wired-port")# type employee (ap) (wired-port-profile "wired-port")# auth-server server1 (ap) (wired-port-profile "wired-port")# auth-server server2 (ap) (wired-port-profile "wired-port")# dot1x (ap) (wired-port-profile "wired-port")# exit (ap) (config)# enet1-port-profile wired-port</pre> <p>Configure a wireless SSID to operate in centralized L2 mode and associate VLAN 20 to the WLAN SSID profile.</p> <pre>(ap) (config) # wlan ssid-profile wireless-ssid (ap) (SSID Profile "wireless-ssid")# enable (ap) (SSID Profile "wireless-ssid")# type employee (ap) (SSID Profile "wireless-ssid")# essid wireless-ssid (ap) (SSID Profile "wireless-ssid")# opmode wpa2-aes (ap) (SSID Profile "wireless-ssid")# vlan 20 (ap) (SSID Profile "wireless-ssid")# auth-server server1 (ap) (SSID Profile "wireless-ssid")# auth-server server2 (ap) (SSID Profile "wireless-ssid")# auth-survivability</pre>	<p>See Configuring a Wired Profile and Wireless Network Profiles</p>
<p>7. Create access rule for wired and wireless authentication.</p>	<p>For wired profile:</p> <pre>(ap) (config)# wlan access-rule wired-port (ap) (Access Rule "wired-port")# rule any any match any any any permit</pre>	<p>See Configuring ACL Rules for Network</p>

Table 83: OAW-IAP Configuration for Scenario—GRE: Single Datacenter Deployment with No Redundancy

Configuration Steps	CLI Commands	UI Procedure
	For WLAN SSID employee roles: (ap)(config)# wlan access-rule wireless-ssid (ap)(Access Rule "wireless-ssid")# rule any any match any any any permit	Services
NOTE: Ensure that you execute the commit apply command in the AOS-W Instant CLI before saving the configuration and propagating changes across the OAW-IAP cluster.		

AP Connected Switch Configuration

Client VLANs defined in this example must be opened on the upstream switches in multiple AP deployments, as client traffic from slave to master is tagged with the client VLAN.

Datacenter Configuration

For information on switch configuration, see [Configuring a Switch for IAP-VPN Operations on page 251](#). The following GRE configuration is required on the switch:

```
(host)(config)# interface tunnel <Number>
(host)(config-tunnel)# description <Description>
(host)(config-tunnel)# tunnel mode gre <ID>
(host)(config-tunnel)# tunnel source <switch-IP>
(host)(config-tunnel)# tunnel destination <AP-IP>
(host)(config-tunnel)# trusted
(host)(config-tunnel)# tunnel vlan <allowed-VLAN>
```

Glossary

The following table lists the terms and their definitions used in this document.

Table 84: *List of Terms*

Term	Definition
802.11	An evolving family of specifications for wireless LANs developed by a working group of the Institute of Electrical and Electronics Engineers (IEEE). 802.11 standards use the Ethernet protocol and CSMA/CA (carrier sense multiple access with collision avoidance) for path sharing.
802.11a	Provides specifications for wireless systems. Networks using 802.11a operate at radio frequencies in the 5GHz band. The specification uses a modulation scheme known as orthogonal frequency-division multiplexing (OFDM) that is especially well suited to use in office settings. The maximum data transfer rate is 54 Mbps.
802.11b	WLAN standard often called Wi-Fi; backward compatible with 802.11. Instead of the phase-shift keying (PSK) modulation method historically used in 802.11 standards, 802.11b uses complementary code keying (CCK), which allows higher data speeds and is less susceptible to multipath-propagation interference. 802.11b operates in the 2.4 GHz band and the maximum data transfer rate is 11 Mbps.
802.11g	Offers transmission over relatively short distances at up to 54 Mbps, compared with the 11 Mbps theoretical maximum of 802.11b. 802.11g operates in the 2.4 GHz band and employs orthogonal frequency division multiplexing (OFDM), the modulation scheme used in 802.11a, to obtain higher data speed. Computers or terminals set up for 802.11g can fall back to speeds of 11 Mbps, so that 802.11b and 802.11g devices can be compatible within a single network.
802.11n	Wireless networking standard to improve network throughput over the two previous standards 802.11a and 802.11g with a significant increase in the maximum raw data rate from 54 Mbps to 600 Mbps with the use of four spatial streams at a channel width of 40 MHz. 802.11n operates in the 2.4 and 5.0 bands.
AP	An access point (AP) connects users to other users within the network and also can serve as the point of interconnection between the WLAN and a fixed wire network. The number of access points a WLAN needs is determined by the number of users and the size of the network.
access point mapping	The act of locating and possibly exploiting connections to WLANs while driving around a city or elsewhere. To do war driving, you need a vehicle, a computer (which can be a laptop), a wireless Ethernet card set to work in promiscuous mode, and some kind of an antenna which can be mounted on top of or positioned inside the car. Because a WLAN may have a range that extends beyond an office building, an outside user may be able to intrude into the network, obtain a free Internet connection, and possibly gain access to company records and other resources.

Table 84: *List of Terms*

Term	Definition
ad-hoc network	A LAN or other small network, especially one with wireless or temporary plug-in connections, in which some of the network devices are part of the network only for the duration of a communications session or, in the case of mobile or portable devices, while in some close proximity to the rest of the network.
band	A specified range of frequencies of electromagnetic radiation.
DHCP	The Dynamic Host Configuration Protocol (DHCP) is an auto-configuration protocol used on IP networks. Computers or any network peripherals that are connected to IP networks must be configured, before they can communicate with other computers on the network. DHCP allows a computer to be configured automatically, eliminating the need for a network administrator. DHCP also provides a central database to keep track of computers connected to the network. This database helps in preventing any two computers from being configured with the same IP address.
DNS Server	<p>A Domain Name System (DNS) server functions as a phonebook for the Internet and Internet users. It converts human readable computer hostnames into IP addresses and vice-versa.</p> <p>A DNS server stores several records for a domain name such as an address 'A' record, name server (NS), and mail exchanger (MX) records. The Address 'A' record is the most important record that is stored in a DNS server, because it provides the required IP address for a network peripheral or element.</p>
DST	Daylight saving time (DST), also known as summer time, is the practice of advancing clocks, so that evenings have more daylight and mornings have less. Typically clocks are adjusted forward one hour near the start of spring and are adjusted backward in autumn.
EAP	Extensible authentication protocol (EAP) refers to the authentication protocol in wireless networks that expands on methods used by the point-to-point protocol (PPP), a protocol often used when connecting a computer to the Internet. EAP can support multiple authentication mechanisms, such as token cards, smart cards, certificates, one-time passwords, and public key encryption authentication.
fixed wireless	Wireless devices or systems in fixed locations such as homes and offices. Fixed wireless devices usually derive their electrical power from the utility mains, unlike mobile wireless or portable wireless which tend to be battery-powered. Although mobile and portable systems can be used in fixed locations, efficiency and bandwidth are compromised compared with fixed systems.
frequency allocation	Use of radio frequency spectrum regulated by governments.
frequency spectrum	Part of the electromagnetic spectrum.

Table 84: *List of Terms*

Term	Definition
hotspot	A WLAN node that provides Internet connection and virtual private network (VPN) access from a given location. A business traveler, for example, with a laptop equipped for Wi-Fi can look up a local hot spot, contact it, and get connected through its network to reach the Internet and their own company remotely with a secure connection. Increasingly, public places, such as airports, hotels, and coffee shops are providing free wireless access for customers.
IEEE 802.11 standards	The IEEE 802.11 is a set of standards that are categorized based on the radio wave frequency and the data transfer rate.
POE	Power over Ethernet (PoE) is a method of delivering power on the same physical Ethernet wire used for data communication. Power for devices is provided in one of the following two ways: <ul style="list-style-type: none">• Endspan— The switch that an AP is connected for power supply.• Midspan— A device can sit between the switch and APs The choice of endspan or midspan depends on the capabilities of the switch to which the OAW-IAP is connected. Typically if a switch is in place and does not support PoE, midspan power injectors are used.
PPPoE	Point-to-Point Protocol over Ethernet (PPPoE) is a method of connecting to the Internet typically used with DSL services where the client connects to the DSL modem.
QoS	Quality of Service (QoS) refers to the capability of a network to provide better service to a specific network traffic over various technologies.
RF	Radio Frequency (RF) refers to the portion of electromagnetic spectrum in which electromagnetic waves are generated by feeding alternating current to an antenna.
TACACS	Family of protocols that handle remote authentication and related services for network access control through a centralized server.
TACACS+	Derived from TACACS but an entirely new and separate protocol to handle AAA services. TACACS+ uses TCP and is not compatible with TACACS. Because it encrypts password, username, authorization, and accounting, it is less vulnerable than RADIUS.
VPN	A Virtual Private Network (VPN) network that uses a public telecommunication infrastructure, such as the Internet, to provide remote offices or individual users with secure access to their organization's network. A VPN ensures privacy through security procedures and tunneling protocols such as the Layer Two Tunneling Protocol (L2TP). Data is encrypted at the sending end and decrypted at the receiving end.

Table 84: *List of Terms*

Term	Definition
W-CDMA	Officially known as IMT-2000 direct spread; ITU standard derived from Code-Division Multiple Access (CDMA). Wideband code-division multiple access (W-CDMA) is a third-generation (3G) mobile wireless technology that promises much higher data speeds to mobile and portable wireless devices than commonly offered in today's market.
Wi-Fi	A term for certain types of WLANs. Wi-Fi can apply to products that use any 802.11 standard. Wi-Fi has gained acceptance in many businesses, agencies, schools, and homes as an alternative to a wired LAN. Many airports, hotels, and fast-food facilities offer public access to Wi-Fi networks.
WEP	Wired equivalent privacy (WEP) is a security protocol specified in 802.11b, designed to provide a WLAN with a level of security and privacy comparable to what is usually expected of a wired LAN. Data encryption protects the vulnerable wireless link between clients and access points; once this measure has been taken, other typical LAN security mechanisms such as password protection, end-to-end encryption, virtual private networks (VPNs), and authentication can be put in place to ensure privacy.
wireless	Describes telecommunications in which electromagnetic waves (rather than some form of wire) carry the signal over part or all of the communication path.
wireless network	In a Wireless LAN (WLAN), laptops, desktops, PDAs, and other computer peripherals are connected to each other without any network cables. These network elements or clients use radio signals to communicate with each other. Wireless networks are set up based on the IEEE 802.11 standards.
WISP	Wireless ISP (WISP) refers to an internet service provider (ISP) that allows subscribers to connect to a server at designated hot spots (access points) using a wireless connection such as Wi-Fi. This type of ISP offers broadband service and allows subscriber computers, called stations, to access the Internet and the web from anywhere within the zone of coverage provided by the server antenna, usually a region with a radius of several kilometers.
wireless service provider	A company that offers transmission services to users of wireless devices through radio frequency (RF) signals rather than through end-to-end wire communication.
WLAN	Wireless local area network (WLAN) is a local area network (LAN) that the users access through a wireless connection.

Acronyms and Abbreviations

The following table lists the abbreviations used in this document.

Table 85: *List of abbreviations*

Abbreviation	Expansion
ARM	Adaptive Radio Management
ARP	Address Resolution Protocol
BSS	Basic Server Set
BSSID	Basic Server Set Identifier
CA	Certification Authority
CLI	Command Line Interface
DHCP	Dynamic Host Configuration Protocol
DMZ	Demilitarized Zone
DNS	Domain Name System
EAP-TLS	Extensible Authentication Protocol- Transport Layer Security
EAP-TTLS	Extensible Authentication Protocol-Tunneled Transport Layer Security
OAW-IAP	Instant Access Point
IDS	Intrusion Detection System
IEEE	Institute of Electrical and Electronics Engineers
ISP	Internet Service Provider
LEAP	Lightweight Extensible Authentication Protocol
MX	Mail Exchanger
MAC	Media Access Control
NAS	Network Access Server
NAT	Network Address Translation

Table 85: *List of abbreviations*

Abbreviation	Expansion
NS	Name Server
NTP	Network Time Protocol
PEAP	Protected Extensible Authentication Protocol
PEM	Privacy Enhanced Mail
PoE	Power over Ethernet
RADIUS	Remote Authentication Dial In User Service
VC	Virtual Controller
VSA	Vendor-Specific Attributes
WLAN	Wireless Local Area Network

Glossary

The following table lists the terms and their definitions used in this document.

Table 86: *List of Terms*

Term	Definition
802.11	An evolving family of specifications for wireless LANs developed by a working group of the Institute of Electrical and Electronics Engineers (IEEE). 802.11 standards use the Ethernet protocol and CSMA/CA (carrier sense multiple access with collision avoidance) for path sharing.
802.11a	Provides specifications for wireless systems. Networks using 802.11a operate at radio frequencies in the 5GHz band. The specification uses a modulation scheme known as orthogonal frequency-division multiplexing (OFDM) that is especially well suited to use in office settings. The maximum data transfer rate is 54 Mbps.
802.11b	WLAN standard often called Wi-Fi; backward compatible with 802.11. Instead of the phase-shift keying (PSK) modulation method historically used in 802.11 standards, 802.11b uses complementary code keying (CCK), which allows higher data speeds and is less susceptible to multipath-propagation interference. 802.11b operates in the 2.4 GHz band and the maximum data transfer rate is 11 Mbps.

Table 86: *List of Terms*

Term	Definition
802.11g	Offers transmission over relatively short distances at up to 54 Mbps, compared with the 11 Mbps theoretical maximum of 802.11b. 802.11g operates in the 2.4 GHz band and employs orthogonal frequency division multiplexing (OFDM), the modulation scheme used in 802.11a, to obtain higher data speed. Computers or terminals set up for 802.11g can fall back to speeds of 11 Mbps, so that 802.11b and 802.11g devices can be compatible within a single network.
802.11n	Wireless networking standard to improve network throughput over the two previous standards 802.11a and 802.11g with a significant increase in the maximum raw data rate from 54 Mbps to 600 Mbps with the use of four spatial streams at a channel width of 40 MHz. 802.11n operates in the 2.4 and 5.0 bands.
AP	An access point (AP) connects users to other users within the network and also can serve as the point of interconnection between the WLAN and a fixed wire network. The number of access points a WLAN needs is determined by the number of users and the size of the network.
access point mapping	The act of locating and possibly exploiting connections to WLANs while driving around a city or elsewhere. To do war driving, you need a vehicle, a computer (which can be a laptop), a wireless Ethernet card set to work in promiscuous mode, and some kind of an antenna which can be mounted on top of or positioned inside the car. Because a WLAN may have a range that extends beyond an office building, an outside user may be able to intrude into the network, obtain a free Internet connection, and possibly gain access to company records and other resources.
ad-hoc network	A LAN or other small network, especially one with wireless or temporary plug-in connections, in which some of the network devices are part of the network only for the duration of a communications session or, in the case of mobile or portable devices, while in some close proximity to the rest of the network.
band	A specified range of frequencies of electromagnetic radiation.
DHCP	The Dynamic Host Configuration Protocol (DHCP) is an auto-configuration protocol used on IP networks. Computers or any network peripherals that are connected to IP networks must be configured, before they can communicate with other computers on the network. DHCP allows a computer to be configured automatically, eliminating the need for a network administrator. DHCP also provides a central database to keep track of computers connected to the network. This database helps in preventing any two computers from being configured with the same IP address.

Table 86: *List of Terms*

Term	Definition
DNS Server	<p>A Domain Name System (DNS) server functions as a phonebook for the Internet and Internet users. It converts human readable computer hostnames into IP addresses and vice-versa.</p> <p>A DNS server stores several records for a domain name such as an address 'A' record, name server (NS), and mail exchanger (MX) records. The Address 'A' record is the most important record that is stored in a DNS server, because it provides the required IP address for a network peripheral or element.</p>
DST	<p>Daylight saving time (DST), also known as summer time, is the practice of advancing clocks, so that evenings have more daylight and mornings have less. Typically clocks are adjusted forward one hour near the start of spring and are adjusted backward in autumn.</p>
EAP	<p>Extensible authentication protocol (EAP) refers to the authentication protocol in wireless networks that expands on methods used by the point-to-point protocol (PPP), a protocol often used when connecting a computer to the Internet. EAP can support multiple authentication mechanisms, such as token cards, smart cards, certificates, one-time passwords, and public key encryption authentication.</p>
fixed wireless	<p>Wireless devices or systems in fixed locations such as homes and offices. Fixed wireless devices usually derive their electrical power from the utility mains, unlike mobile wireless or portable wireless which tend to be battery-powered. Although mobile and portable systems can be used in fixed locations, efficiency and bandwidth are compromised compared with fixed systems.</p>
frequency allocation	<p>Use of radio frequency spectrum regulated by governments.</p>
frequency spectrum	<p>Part of the electromagnetic spectrum.</p>
hotspot	<p>A WLAN node that provides Internet connection and virtual private network (VPN) access from a given location. A business traveler, for example, with a laptop equipped for Wi-Fi can look up a local hot spot, contact it, and get connected through its network to reach the Internet and their own company remotely with a secure connection. Increasingly, public places, such as airports, hotels, and coffee shops are providing free wireless access for customers.</p>
IEEE 802.11 standards	<p>The IEEE 802.11 is a set of standards that are categorized based on the radio wave frequency and the data transfer rate.</p>
POE	<p>Power over Ethernet (PoE) is a method of delivering power on the same physical Ethernet wire used for data communication. Power for devices is provided in one of the following two ways:</p> <ul style="list-style-type: none">● Endspan— The switch that an AP is connected for power supply.● Midspan— A device can sit between the switch and APs

Table 86: List of Terms

Term	Definition
	The choice of endspan or midspan depends on the capabilities of the switch to which the OAW-IAP is connected. Typically if a switch is in place and does not support PoE, midspan power injectors are used.
PPPoE	Point-to-Point Protocol over Ethernet (PPPoE) is a method of connecting to the Internet typically used with DSL services where the client connects to the DSL modem.
QoS	Quality of Service (QoS) refers to the capability of a network to provide better service to a specific network traffic over various technologies.
RF	Radio Frequency (RF) refers to the portion of electromagnetic spectrum in which electromagnetic waves are generated by feeding alternating current to an antenna.
TACACS	Family of protocols that handle remote authentication and related services for network access control through a centralized server.
TACACS+	Derived from TACACS but an entirely new and separate protocol to handle AAA services. TACACS+ uses TCP and is not compatible with TACACS. Because it encrypts password, username, authorization, and accounting, it is less vulnerable than RADIUS.
VPN	A Virtual Private Network (VPN) network that uses a public telecommunication infrastructure, such as the Internet, to provide remote offices or individual users with secure access to their organization's network. A VPN ensures privacy through security procedures and tunneling protocols such as the Layer Two Tunneling Protocol (L2TP). Data is encrypted at the sending end and decrypted at the receiving end.
W-CDMA	Officially known as IMT-2000 direct spread; ITU standard derived from Code-Division Multiple Access (CDMA). Wideband code-division multiple access (W-CDMA) is a third-generation (3G) mobile wireless technology that promises much higher data speeds to mobile and portable wireless devices than commonly offered in today's market.
Wi-Fi	A term for certain types of WLANs. Wi-Fi can apply to products that use any 802.11 standard. Wi-Fi has gained acceptance in many businesses, agencies, schools, and homes as an alternative to a wired LAN. Many airports, hotels, and fast-food facilities offer public access to Wi-Fi networks.

Table 86: *List of Terms*

Term	Definition
WEP	Wired equivalent privacy (WEP) is a security protocol specified in 802.11b, designed to provide a WLAN with a level of security and privacy comparable to what is usually expected of a wired LAN. Data encryption protects the vulnerable wireless link between clients and access points; once this measure has been taken, other typical LAN security mechanisms such as password protection, end-to-end encryption, virtual private networks (VPNs), and authentication can be put in place to ensure privacy.
wireless	Describes telecommunications in which electromagnetic waves (rather than some form of wire) carry the signal over part or all of the communication path.
wireless network	In a Wireless LAN (WLAN), laptops, desktops, PDAs, and other computer peripherals are connected to each other without any network cables. These network elements or clients use radio signals to communicate with each other. Wireless networks are set up based on the IEEE 802.11 standards.
WISP	Wireless ISP (WISP) refers to an internet service provider (ISP) that allows subscribers to connect to a server at designated hot spots (access points) using a wireless connection such as Wi-Fi. This type of ISP offers broadband service and allows subscriber computers, called stations, to access the Internet and the web from anywhere within the zone of coverage provided by the server antenna, usually a region with a radius of several kilometers.
wireless service provider	A company that offers transmission services to users of wireless devices through radio frequency (RF) signals rather than through end-to-end wire communication.
WLAN	Wireless local area network (WLAN) is a local area network (LAN) that the users access through a wireless connection.